

UC30-215164

UC30

ULTRASONIC DISTANCE SENSORS

SICK
Sensor Intelligence.



Ordering information

Type	part no.
UC30-215164	6054717

Other models and accessories → www.sick.com/UC30



Detailed technical data

Features

Operating range, limiting range	600 mm ... 6,000 mm, 8,000 mm
Resolution	≥ 0.18 mm
Repeatability	± 0.15 % ¹⁾
Measurement accuracy	± 1 % ^{2) 3)}
Temperature compensation	✓
Response time	240 ms
Switching frequency	3 Hz
Output time	60 ms
Ultrasonic frequency (typical)	80 kHz
Detection area (typical)	See diagrams
Additional function	Adjustable operating modes: Switching point (Dt0) / Switching window/Background (ObSB), teach-in of digital output, set levels of digital outputs, invertable digital output, set on delay digital output, synchronization of up to 50 sensors, multiplexing: no cross talk of up to 50 sensors, adjustable measurement filters: Measured value filters/Filter strength/Foreground suppression/Detection area/Sensitivity and sound beam, reset to factory default
Safety-related parameters	
	MTTF _D 101 years
	DC _{avg} 0%

¹⁾ In relation to the current measured value, minimum value ≥ resolution.

²⁾ Referring to current measurement value.

³⁾ Temperature compensation can be switched off, without temperature compensation: 0.17 % / K.

Interfaces

Digital output	Number	Type
	2 ¹⁾	NPN

¹⁾ NPN: HIGH = ≤ 2 V / LOW = U_v.

Maximum output current I_A	≤ 200 mA
Multifunctional input (MF)	1 x MF
Hysteresis	100 mm

¹⁾ NPN: HIGH = ≤ 2 V / LOW = U_V .

Electronics

Supply voltage U_B	DC 9 V ... 30 V ¹⁾
Power consumption	≤ 1.2 W ²⁾
Initialization time	< 450 ms
Display	2 x LED
Enclosure rating	IP65 / IP67
Protection class	III

¹⁾ Limit values, reverse-polarity protected Operation in short-circuit protected network: max. 8 A, class 2.

²⁾ Without load.

Mechanics

Dimensions (W x H x D)	62 mm x 62 mm x 37.2 mm ¹⁾ 62 mm x 62 mm x 36.7 mm ²⁾
Design	Rectangular
Sending axis	Straight
Housing material	Plastic (PBT/PET, ultrasonic transducer: polyurethane foam, glass epoxy resin)
Weight	240 g
Connection type	Male connector, M12, 5-pin

¹⁾ Serial number S/N 2405xxxx or higher.

²⁾ Up to serial number S/N 2404xxxx.

Ambient data

Ambient temperature, operation	-25 °C ... +70 °C
Ambient temperature, storage	-40 °C ... +85 °C

Certificates

EU declaration of conformity	✓
UK declaration of conformity	✓
ACMA declaration of conformity	✓
Moroccan declaration of conformity	✓
China RoHS	✓
cULus certificate	✓

Classifications

ECLASS 5.0	27270804
ECLASS 5.1.4	27270804
ECLASS 6.0	27270804
ECLASS 6.2	27270804
ECLASS 7.0	27270804

ECLASS 8.0	27270804
ECLASS 8.1	27270804
ECLASS 9.0	27270804
ECLASS 10.0	27270804
ECLASS 11.0	27270804
ECLASS 12.0	27272806
ETIM 5.0	EC001846
ETIM 6.0	EC001846
ETIM 7.0	EC001846
ETIM 8.0	EC001846
UNSPSC 16.0901	41111960

Dimensional drawing | serial number S/N 2405xxxx or higher

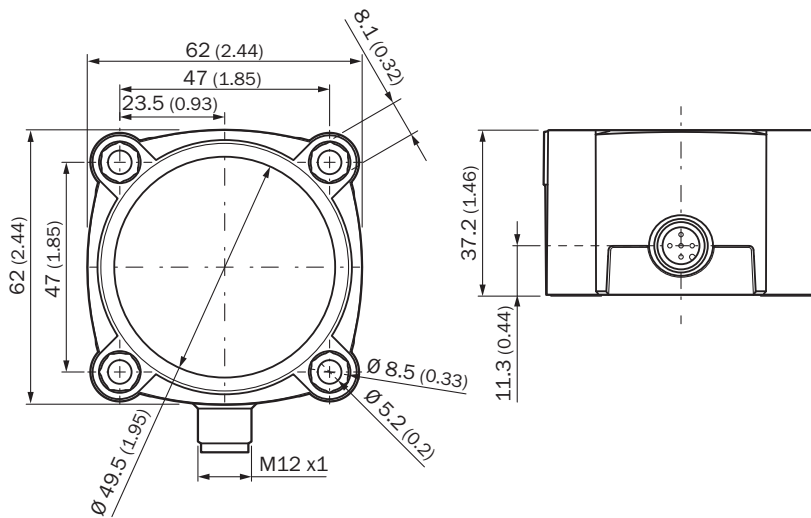

Dimensions in mm (inch)

Note: The position of the screw head in the hole is now 12 mm deeper, please check the screw length.

Connection type

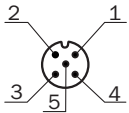

Connection diagram

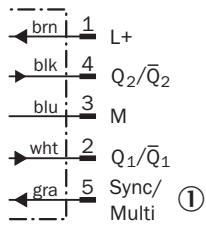

① Synchronization and multiplex mode, Connect+ communication

Adjustment possible | serial number S/N 2405xxxx or higher

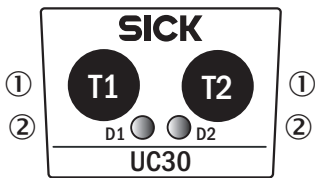

- ① Control elements
- ② LED status indicator

Detection area

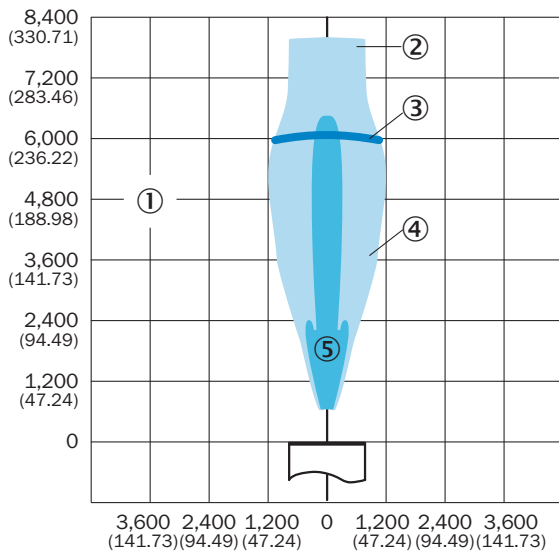





dimensions in mm (inch)

- ① Detection range dependent on reflection properties, size, and alignment of the object
- ② Limiting range
- ③ operating range
- ④ example object: aligned plate 500 mm x 500 mm
- ⑤ example object: pipe with 27 mm diameter

Recommended accessories

Other models and accessories → www.sick.com/UC30

	Brief description	Type	part no.
programming devices			
	<ul style="list-style-type: none"> Product segment: Integration modules and adapters Product family: Cloning modules Description: Tool for visualization, configuration and cloning, 3-digit LED display, supply voltage: DV 9 V ... 30 V 	Connect+ adapter (CPA)	6037782
connectors and cables			
	<ul style="list-style-type: none"> Connection type head A: Female connector, M12, 5-pin, straight, A-coded Connection type head B: Flying leads Signal type: Sensor/actuator cable Cable: 2 m, 5-wire, PVC Description: Sensor/actuator cable, unshielded Application: Zones with chemicals, Uncontaminated zones 	YF2A15-020VB5XLEAX	2096239
	<ul style="list-style-type: none"> Connection type head A: Female connector, M12, 5-pin, straight, A-coded Connection type head B: Flying leads Signal type: Sensor/actuator cable Cable: 0.6 m, 5-wire, PVC Description: Sensor/actuator cable, unshielded Application: Zones with chemicals, Uncontaminated zones 	YF2A15-C60VB5XLEAX	2145570
	<ul style="list-style-type: none"> Connection type head A: Female connector, M12, 5-pin, straight, A-coded Connection type head B: Flying leads Signal type: Sensor/actuator cable Cable: 3 m, 5-wire, PVC Description: Sensor/actuator cable, unshielded Application: Zones with chemicals, Uncontaminated zones 	YF2A15-030VB5XLEAX	2145572

SICK AT A GLANCE

SICK is one of the leading manufacturers of intelligent sensors and sensor solutions for industrial applications. A unique range of products and services creates the perfect basis for controlling processes securely and efficiently, protecting individuals from accidents and preventing damage to the environment.

We have extensive experience in a wide range of industries and understand their processes and requirements. With intelligent sensors, we can deliver exactly what our customers need. In application centers in Europe, Asia and North America, system solutions are tested and optimized in accordance with customer specifications. All this makes us a reliable supplier and development partner.

Comprehensive services complete our offering: SICK LifeTime Services provide support throughout the machine life cycle and ensure safety and productivity.

For us, that is “Sensor Intelligence.”

WORLDWIDE PRESENCE:

Contacts and other locations –www.sick.com