



AOD1-SR25Q2

Display modules

INTEGRATION MODULES AND ADAPTERS

SICK
Sensor Intelligence.



Ordering information

Type	part no.
AOD1-SR25Q2	6054273

Other models and accessories → www.sick.com/Display_modules



Detailed technical data

Features

Product segment	Integration modules and adapters
Product	Display modules
Description	OD Mini evaluation unit, slave, 2 x Q, M12 male connector, 5-pin
Enclosure rating	IP50
Power consumption	1)
Ambient operating temperature	-25 °C ... +50 °C
Weight	120 g

1) Without connected sensor heads.

Certificates

EU declaration of conformity	✓
UK declaration of conformity	✓
ACMA declaration of conformity	✓
Moroccan declaration of conformity	✓
China RoHS	✓
Information according to Art. 3 of Data Act (Regulation EU 2023/2854)	✓

Classifications

ECLASS 5.0	27270890
ECLASS 5.1.4	27270890
ECLASS 6.0	27270890
ECLASS 6.2	27270890
ECLASS 7.0	27270890
ECLASS 8.0	27270890
ECLASS 8.1	27270890
ECLASS 9.0	27270892
ECLASS 10.0	27270892
ECLASS 11.0	27270892
ECLASS 12.0	27270992

ETIM 5.0	EC001825
ETIM 6.0	EC001825
ETIM 7.0	EC001825
ETIM 8.0	EC001825
UNSPSC 16.0901	41111613

Dimensional drawing

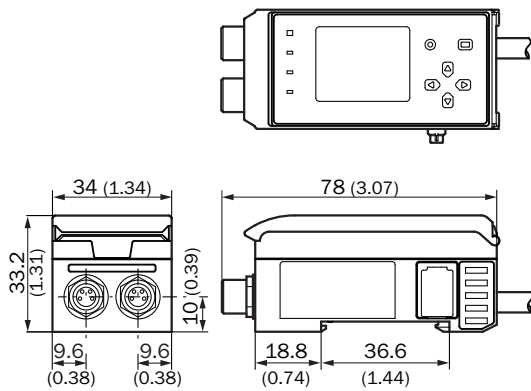

Dimensions in mm (inch)

Anschlusschema

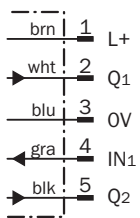



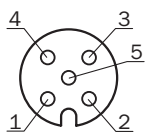

PIN assignment



- ① L+
- ② Q₁: Digital output PNP/NPN
- ③ 0 V
- ④ IN₁: Digital input
- ⑤ Q₂: Digital output PNP/NPN

Recommended accessories

Other models and accessories → www.sick.com/Display_modules

	Brief description	Type	part no.
connectors and cables			
	<ul style="list-style-type: none"> Description: Highly flexible Connection type head A: Female connector, M12, 4-pin, straight Connection type head B: Male connector, M8, 4-pin Cable: 2 m, PUR 	DSL-2804-G02MB	6059743
	<ul style="list-style-type: none"> Description: Sensor/actuator cable, unshielded Connection type head A: Female connector, M12, 4-pin, straight, A-coded Connection type head B: Male connector, M8, 4-pin, straight, A-coded Signal type: Sensor/actuator cable Cable: 2 m, 4-wire, PUR, halogen-free Application: Drag chain operation, Zones with oils and lubricants, Robot, Drag chain operation 	YF2A14-020UA3M8U14	2096112
integration modules and adapters			
	<ul style="list-style-type: none"> Description: IO-Link Smart Sensor Gateway for WLL180T, KTL180 and AOD1; Features: IO-Link; COM3; M8 connection, 4-pin; full read/write functionality for the process and service data of the connected sensors. See operating instructions for additional information and technical details 	WI180C-IOA00	6071650
	<ul style="list-style-type: none"> Description: EtherCAT coupler for WLL180T, KTL180 and AOD1. Features: EtherCAT; transmission rates of up to 100 Mbaud; M12 EtherCAT connection; M8 voltage supply connection, 4-pin; full read/write functionality for the process and service data of the connected sensors. See operating instructions for additional information and technical details 	WI180C-EC	6068089
	<ul style="list-style-type: none"> Description: PROFINET coupler for WLL180T, KTL180 and AOD1. Features: PROFINET IRT; transmission rates 10 Mbaud – 100 Mbaud; M12 PROFINET connection; M8 voltage supply connection, 4-pin; full read/write functionality for the process and service data of the connected sensors. See operating instructions for additional information and technical details 	WI180C-PN	6068088

SICK AT A GLANCE

SICK is one of the leading manufacturers of intelligent sensors and sensor solutions for industrial applications. A unique range of products and services creates the perfect basis for controlling processes securely and efficiently, protecting individuals from accidents and preventing damage to the environment.

We have extensive experience in a wide range of industries and understand their processes and requirements. With intelligent sensors, we can deliver exactly what our customers need. In application centers in Europe, Asia and North America, system solutions are tested and optimized in accordance with customer specifications. All this makes us a reliable supplier and development partner.

Comprehensive services complete our offering: SICK LifeTime Services provide support throughout the machine life cycle and ensure safety and productivity.

For us, that is “Sensor Intelligence.”

WORLDWIDE PRESENCE:

Contacts and other locations –www.sick.com