



WFS3-40N41C

WFS

FORK SENSORS

SICK
Sensor Intelligence.



Illustration may differ



Ordering information

Type	part no.
WFS3-40N41C	6053766

Other models and accessories → www.sick.com/WFS

Detailed technical data

Features

Functional principle	Optical detection principle
Dimensions (W x H x D)	10 mm x 25 mm x 64.3 mm
Fork width	3 mm
Fork depth	42 mm
Light source	LED, Infrared light
Label detection	✓
Minimum detectable object (MDO)	Gap between Labels / Size of labels: 2 mm ¹⁾
Adjustment	Plus/minus button, cable (Teach-in, sensitivity, light/dark switching, Teach-in dynamic)
Teach-in mode	2-point teach-in Teach-in dynamic
Safety-related parameters	
	MTTF _D 97 years
	DC _{avg} 0 %

¹⁾ Depends on the label thickness.

Interfaces

IO-Link	✓ , IO-Link V1.1
	VendorID 26
	DeviceID HEX 80006F
	DeviceID DEC 8388719
Cycle time	2.3 ms

Electronics

Supply voltage	10 V DC ... 30 V DC
Ripple	< 10 %
Current consumption	20 mA ¹⁾
Initialization time	40 ms
Switching frequency	15 kHz
Response time	≤ 46 μs
Stability of response time	± 20 μs
Jitter	17 μs
Switching output	NPN
Switching output (voltage)	NPN: HIGH = approx. U_V / LOW ≤ 2 V
Switching mode	Light/dark switching
Output current I_{max}	100 mA
Input, teach-in (ET)	Teach: $U > 5 V \dots < U_V$
Protection class	III
Circuit protection	U_V connections, reverse polarity protected Output Q short-circuit protected Interference pulse suppression
Connection type	Male connector M8, 4-pin

¹⁾ Without load.

Mechanics

Housing material	PA (glass-fiber reinforced)
Weight	Approx. 36 g

Ambient data

Ambient operating temperature	-20 °C ... +60 °C ¹⁾
Ambient temperature, storage	-30 °C ... +80 °C
Ambient light immunity	≤ 10,000 lx
Shock load	According to EN 60068-2-27
Enclosure rating	IP65
UL File No.	NRKH.E191603

¹⁾ Do not bend below 0 °C.

Certificates

EU declaration of conformity	✓
UK declaration of conformity	✓
ACMA declaration of conformity	✓
Moroccan declaration of conformity	✓
China RoHS	✓
cULus certificate	✓

IO-Link certificate	✓
Information according to Art. 3 of Data Act (Regulation EU 2023/2854)	✓

Classifications

ECLASS 5.0	27270909
ECLASS 5.1.4	27270909
ECLASS 6.0	27270909
ECLASS 6.2	27270909
ECLASS 7.0	27270909
ECLASS 8.0	27270909
ECLASS 8.1	27270909
ECLASS 9.0	27270909
ECLASS 10.0	27270909
ECLASS 11.0	27270909
ECLASS 12.0	27270909
ETIM 5.0	EC002720
ETIM 6.0	EC002720
ETIM 7.0	EC002720
ETIM 8.0	EC002720
UNSPSC 16.0901	39121528

Dimensional drawing

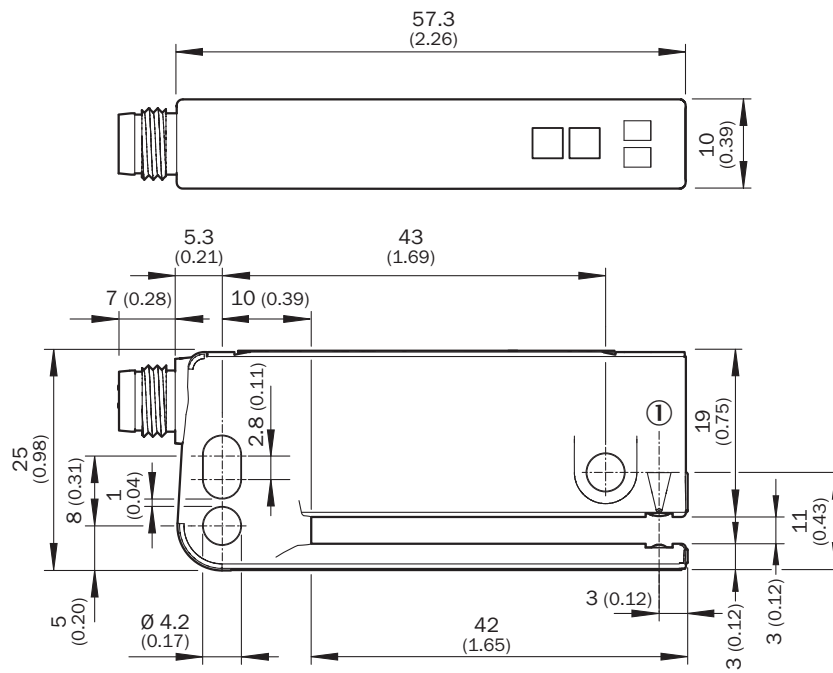

Dimensions in mm (inch)

① Optical axis

Adjustments WFS, IO-Link

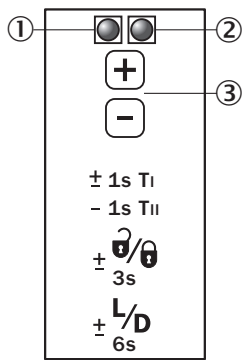

- ① Function signal indicator (yellow)
- ② Power on funktion (green)
- ③ “+”/“-” buttons and function button

Connection diagram Cd-278

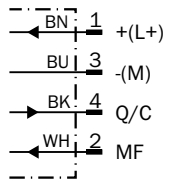

Concept of operation

1. Position label or substrate in the active area of the fork sensor

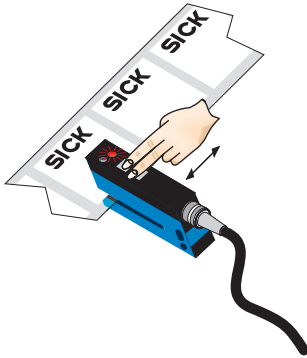

Press both the “+” and “-” buttons together, hold > 1 s and then release the teach-in buttons. The red LED flashes.

2. Move multiple labels through the fork sensor

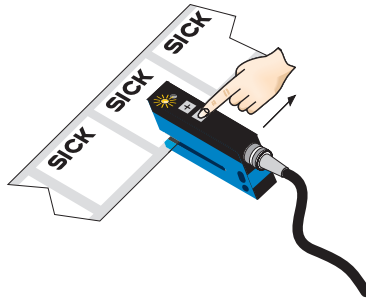

Press “-” button, teach-in process is finished.

Notes

Switching threshold adaptation:







Only, the first teach-in procedure after switching on is permanently stored. Teach-in can be repeated cyclically. Switching output also during teach-in active.

- + Once teach-in process is complete, the switching threshold can be adjusted at any time using the “+” or “-” button. To make minor adjustments, press the “+” or “-” button once. To configure settings quickly, keep the “+” or “-” button pressed for longer.
-
- ± ⏸ / ⏸ Press both the “+” and “-” buttons together (3 seconds) to lock the device and prevent unintentional actuation.
- ± L/D / 6s Press both the “+” and “-” buttons together (6 seconds) to define the switching function (light/dark switching). Standard setting: Q = light switching.

Teach-in (static): Setting the switching threshold without movements of label, cf. operating instruction.

Recommended accessories

Other models and accessories → www.sick.com/WFS

	Brief description	Type	part no.
network devices			
		IOLA2US-01101 (SiLink2 Master)	1061790
		SIG200-0A0412200	1089794
		SIG200-0A0G12200	1102605
Mounting systems			
	<ul style="list-style-type: none"> • Description: WFS mounting rod, straight, including 2 x fixing screws • Material: Steel • Details: Aluminum 	BEF-M12GF-A	2059414
connectors and cables			
	<ul style="list-style-type: none"> • Description: Unshielded • Connection type head A: Male connector, M8, 4-pin, straight, A-coded • Connection systems: Screw-type terminals • Permitted cross-section: 0.14 mm² ... 0.5 mm² 	STE-0804-G	6037323
	<ul style="list-style-type: none"> • Description: Sensor/actuator cable, unshielded • Connection type head A: Female connector, M8, 4-pin, straight, A-coded • Connection type head B: Flying leads • Signal type: Sensor/actuator cable • Cable: 5 m, 4-wire, PVC • Application: Uncontaminated zones, Zones with chemicals 	YF8U14-050VA3XLEAX	2095889

SICK AT A GLANCE

SICK is one of the leading manufacturers of intelligent sensors and sensor solutions for industrial applications. A unique range of products and services creates the perfect basis for controlling processes securely and efficiently, protecting individuals from accidents and preventing damage to the environment.

We have extensive experience in a wide range of industries and understand their processes and requirements. With intelligent sensors, we can deliver exactly what our customers need. In application centers in Europe, Asia and North America, system solutions are tested and optimized in accordance with customer specifications. All this makes us a reliable supplier and development partner.

Comprehensive services complete our offering: SICK LifeTime Services provide support throughout the machine life cycle and ensure safety and productivity.

For us, that is “Sensor Intelligence.”

WORLDWIDE PRESENCE:

Contacts and other locations –www.sick.com