

YM2A8D-020XXXF2A8D

Other connectors and cables

CONNECTORS AND CABLES

SICK
Sensor Intelligence.

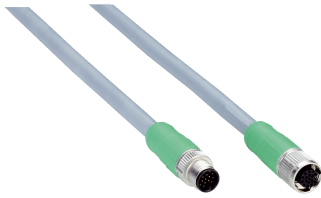

Ordering information

Type	part no.
YM2A8D-020XXXF2A8D	6052286

Other models and accessories → www.sick.com/Other_connectors_and_cables



Detailed technical data

Technical specifications

Connection type head A	Female connector, M12, 17-pin, straight, A-coded
Connection type head B	Male connector, M12, 17-pin, straight, A-coded
Locking plug connector	Quick screw connection
Cable	2 m, 17-wire
Cable diameter	9.1 mm
Shielding	Shielded
Bending radius	
Flexible use	> 10 x cable diameter
Stationary position	> 5 x cable diameter
Drag chain operation	> 10 x cable diameter
Bending cycles	1,000,000
Signal type	Power, serial, CAN, digital I/Os
Special feature	Suitable for 2 A
Application	Drag chain operation
Enclosure rating	IP68
Operating temperature	
Flexible use	-25 °C ... +80 °C
Stationary position	-40 °C ... +80 °C

Certificates

EU declaration of conformity	✓
UK declaration of conformity	✓
China RoHS	✓

Classifications

ECLASS 5.0	19030312
ECLASS 5.1.4	19030312
ECLASS 6.0	27060304
ECLASS 6.2	27060304
ECLASS 7.0	27060304
ECLASS 8.0	27060304
ECLASS 8.1	27060304

ECLASS 9.0	27060304
ECLASS 10.0	27060304
ECLASS 11.0	27060304
ECLASS 12.0	27060304
ETIM 5.0	EC000830
ETIM 6.0	EC000830
ETIM 7.0	EC003249
ETIM 8.0	EC003249
UNSPSC 16.0901	26121604

PIN assignment

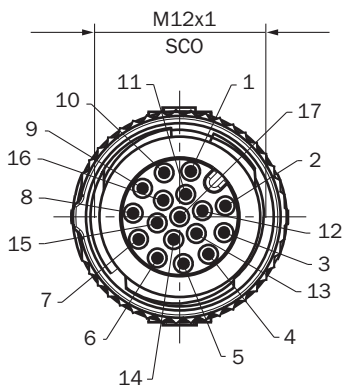

- ① blue
- ② Brown
- ③ Green
- ④ White
- ⑤ Pink
- ⑥ Yellow
- ⑦ Black
- ⑧ Gray
- ⑨ white/black
- ⑩ Violet
- ⑪ gray/pink
- ⑫ red/blue
- ⑬ white/green
- ⑭ brown/green
- ⑮ white/yellow
- ⑯ brown/yellow
- ⑰ white/grey

SICK AT A GLANCE

SICK is one of the leading manufacturers of intelligent sensors and sensor solutions for industrial applications. A unique range of products and services creates the perfect basis for controlling processes securely and efficiently, protecting individuals from accidents and preventing damage to the environment.

We have extensive experience in a wide range of industries and understand their processes and requirements. With intelligent sensors, we can deliver exactly what our customers need. In application centers in Europe, Asia and North America, system solutions are tested and optimized in accordance with customer specifications. All this makes us a reliable supplier and development partner.

Comprehensive services complete our offering: SICK LifeTime Services provide support throughout the machine life cycle and ensure safety and productivity.

For us, that is “Sensor Intelligence.”

WORLDWIDE PRESENCE:

Contacts and other locations –www.sick.com