



# CQ4-08EPOKU1

CQ

**CAPACITIVE PROXIMITY SENSORS**

**SICK**  
Sensor Intelligence.



Illustration may differ



## Ordering information

Type	part no.
CQ4-08EP0KU1	6051010

Other models and accessories → [www.sick.com/CQ](http://www.sick.com/CQ)

## Detailed technical data

### Features

<b>Housing</b>	Rectangular
<b>Dimensions (W x H x D)</b>	16 mm x 39.5 mm x 12 mm
<b>Sensing range <math>S_n</math></b>	1 mm ... 8 mm <sup>1)</sup> 1 mm ... 6 mm <sup>2)</sup>
<b>Safe sensing range <math>S_a</math></b>	5.76 mm
<b>Installation type</b>	Non-flush Flush
<b>Switching frequency</b>	100 Hz
<b>Connection type</b>	Cable, 3-wire, 2 m <sup>3)</sup>
<b>Switching output</b>	PNP
<b>Switching output detail</b>	PNP
<b>Output function</b>	NC
<b>Electrical wiring</b>	DC 3-wire
<b>Adjustment</b>	Potentiometer
	Sensitivity (5 turns)
<b>Enclosure rating</b>	IP67 <sup>4)</sup>
<b>Items supplied</b>	Screwdriver for potentiometer adjustment (1 x)

<sup>1)</sup> For non-flush installation.

<sup>2)</sup> For flush mounting.

<sup>3)</sup> Do not bend below 0 °C.

<sup>4)</sup> According to EN 60529.

## Mechanics/electronics

<b>Supply voltage</b>	10 V DC ... 30 V DC
<b>Ripple</b>	≤ 10 %
<b>Voltage drop</b>	≤ 2.5 V DC <sup>1)</sup>
<b>Current consumption</b>	12 mA <sup>2)</sup>
<b>Time delay before availability</b>	≤ 200 ms
<b>Hysteresis</b>	4 % ... 20 % <sup>3)</sup>
<b>Reproducibility</b>	≤ 5 % <sup>4)</sup> 5)
<b>Temperature drift (of S<sub>r</sub>)</b>	± 20 %
<b>EMC</b>	According to EN 60947-5-2
<b>Continuous current I<sub>a</sub></b>	≤ 150 mA
<b>Cable material</b>	PVC
<b>Short-circuit protection</b>	✓
<b>Power-up pulse protection</b>	✓
<b>Shock and vibration resistance</b>	30 g, 11 ms / 10 ... 55 Hz, 1 mm
<b>Ambient operating temperature</b>	-20 °C ... +75 °C
<b>Ambient temperature, storage</b>	-40 °C ... +85 °C
<b>Housing material</b>	Plastic, ABS
<b>Sensing face material</b>	Plastic
<b>UL File No.</b>	NRKH.E191603

<sup>1)</sup> At I<sub>a</sub> max.

<sup>2)</sup> Without load.

<sup>3)</sup> Depending on installation and environmental conditions and sensitivity adjustment, hysteresis may vary.

<sup>4)</sup> Of S<sub>r</sub>.

<sup>5)</sup> Supply voltage U<sub>B</sub> and constant ambient temperature T<sub>a</sub>.

## Safety-related parameters

<b>MTTF<sub>D</sub></b>	1,344 years
<b>DC<sub>avg</sub></b>	0 %
<b>T<sub>M</sub> (mission time)</b>	20 years

## Reduction factors

<b>Note</b>	The values are reference values which may vary
<b>Metal</b>	1
<b>Water</b>	1
<b>PVC</b>	Approx. 0.4
<b>Oil</b>	Approx. 0.25
<b>Glass</b>	0.6
<b>Ceramics</b>	0.5
<b>Alcohol</b>	0.7
<b>Wood</b>	0.2 ... 0.7

### Installation note

<b>Remark</b>	Associated graphic see "Installation"
<b>A</b>	16 mm
<b>B</b>	16 mm
<b>F</b>	48 mm

### Certificates

<b>EU declaration of conformity</b>	✓
<b>UK declaration of conformity</b>	✓
<b>Moroccan declaration of conformity</b>	✓
<b>China RoHS</b>	✓
<b>cULus certificate</b>	✓

### Classifications

<b>ECLASS 5.0</b>	27270102
<b>ECLASS 5.1.4</b>	27270102
<b>ECLASS 6.0</b>	27270102
<b>ECLASS 6.2</b>	27270102
<b>ECLASS 7.0</b>	27270102
<b>ECLASS 8.0</b>	27270102
<b>ECLASS 8.1</b>	27270102
<b>ECLASS 9.0</b>	27270102
<b>ECLASS 10.0</b>	27270102
<b>ECLASS 11.0</b>	27270102
<b>ECLASS 12.0</b>	27274201
<b>ETIM 5.0</b>	EC002715
<b>ETIM 6.0</b>	EC002715
<b>ETIM 7.0</b>	EC002715
<b>ETIM 8.0</b>	EC002715
<b>UNSPSC 16.0901</b>	39122230

Installation note

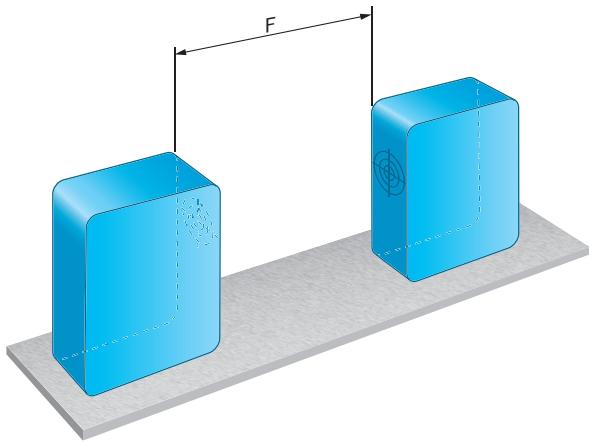

Installation note

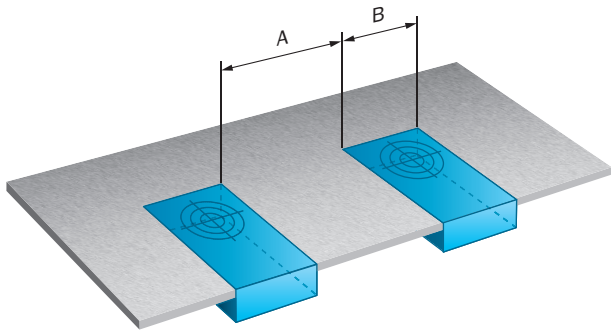

Connection diagram Cd-043

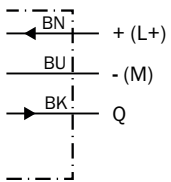

Response diagram CQ4, Non-flush installation

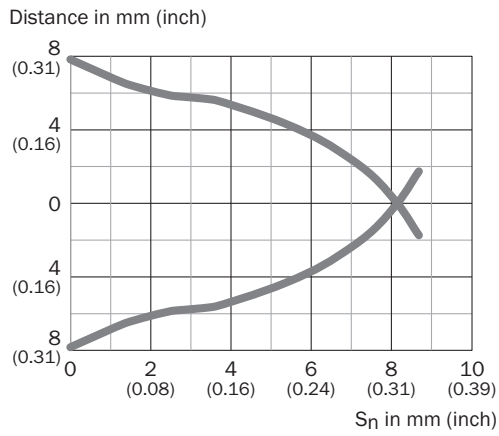

Response diagram CQ4, Flush installation

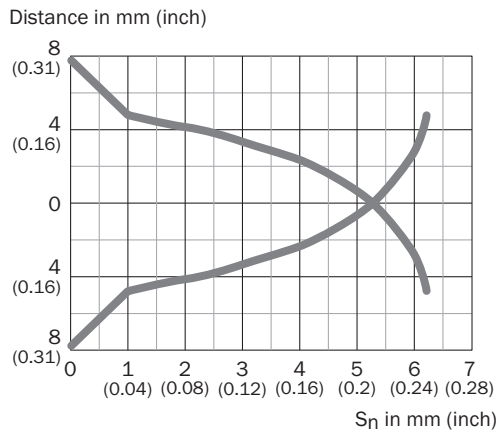

Dimensional drawing CQ4, cable

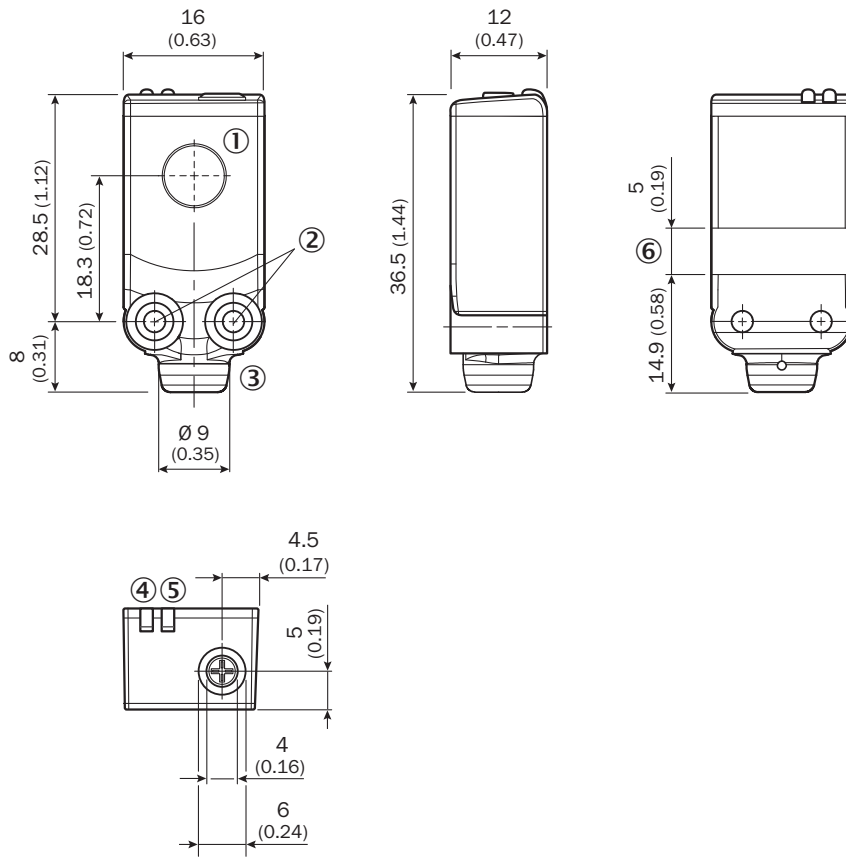





Dimensions in mm (inch)

- ① Sensing face
- ② Threaded hole M3 (2 x)
- ③ Connection
- ④ yellow LED: status detection of object/medium
- ⑤ LED green: operating indicator
- ⑥ line for cable tie

Recommended accessories

Other models and accessories → [www.sick.com/CQ](http://www.sick.com/CQ)

	Brief description	Type	part no.
Mounting systems			
	<ul style="list-style-type: none"> <li><b>Description:</b> Mounting bracket for wall mounting</li> <li><b>Material:</b> Stainless steel</li> <li><b>Details:</b> Stainless steel 1.4571</li> <li><b>Items supplied:</b> Mounting hardware included</li> <li><b>Suitable for:</b> W4S, W4F, W4S</li> </ul>	BEF-W4-A	2051628
	<ul style="list-style-type: none"> <li><b>Description:</b> Mounting bracket for floor mounting</li> <li><b>Material:</b> Stainless steel</li> <li><b>Details:</b> Stainless steel 1.4571</li> <li><b>Items supplied:</b> Mounting hardware included</li> <li><b>Suitable for:</b> W4S, W4F, W4S</li> </ul>	BEF-W4-B	2051630
	<ul style="list-style-type: none"> <li><b>Description:</b> Ball clamp bracket</li> <li><b>Material:</b> Plastic</li> <li><b>Details:</b> Plastic</li> <li><b>Items supplied:</b> Mounting hardware included</li> <li><b>Suitable for:</b> W2S-2, W4-3</li> </ul>	BEF-GH-MINI01	2023160
connectors and cables			
	<ul style="list-style-type: none"> <li><b>Description:</b> Unshielded</li> <li><b>Connection type head A:</b> Male connector, M8, 3-pin, straight, A-coded</li> <li><b>Connection systems:</b> Screw-type terminals</li> <li><b>Permitted cross-section:</b> 0.14 mm<sup>2</sup> ... 0.5 mm<sup>2</sup></li> </ul>	STE-0803-G	6037322
	<ul style="list-style-type: none"> <li><b>Description:</b> Unshielded</li> <li><b>Connection type head A:</b> Female connector, M8, 3-pin, straight, A-coded</li> <li><b>Connection systems:</b> Screw-type terminals</li> <li><b>Permitted cross-section:</b> 0.14 mm<sup>2</sup> ... 0.5 mm<sup>2</sup></li> </ul>	DOS-0803-G	7902077
	<ul style="list-style-type: none"> <li><b>Description:</b> Unshielded</li> <li><b>Connection type head A:</b> Female connector, M8, 3-pin, angled, A-coded</li> <li><b>Connection systems:</b> Solder connection</li> <li><b>Permitted cross-section:</b> ≤ 0.25 mm<sup>2</sup></li> </ul>	DOS-0803-W	7902078

## SICK AT A GLANCE

SICK is one of the leading manufacturers of intelligent sensors and sensor solutions for industrial applications. A unique range of products and services creates the perfect basis for controlling processes securely and efficiently, protecting individuals from accidents and preventing damage to the environment.

We have extensive experience in a wide range of industries and understand their processes and requirements. With intelligent sensors, we can deliver exactly what our customers need. In application centers in Europe, Asia and North America, system solutions are tested and optimized in accordance with customer specifications. All this makes us a reliable supplier and development partner.

Comprehensive services complete our offering: SICK LifeTime Services provide support throughout the machine life cycle and ensure safety and productivity.

For us, that is “Sensor Intelligence.”

## WORLDWIDE PRESENCE:

Contacts and other locations –[www.sick.com](http://www.sick.com)