



# TBS-1DSG11506NE

TBS

TEMPERATURE SENSORS

**SICK**  
Sensor Intelligence.



Illustration may differ



## Ordering information

Type	part no.
TBS-1DSG11506NE	6048679

Other models and accessories → [www.sick.com/TBS](http://www.sick.com/TBS)

## Detailed technical data

### Features

<b>Measuring range</b>	-20 °C ... +80 °C
<b>Sensor element</b>	Pt1000, 2-wire
<b>Output signal</b>	2 x PNP + 4 mA ... 20 mA
<b>Maximum ohmic load R<sub>A</sub></b>	≤ 100 kΩ Switching outputs < 0.5 kΩ output signal 4 mA ... 20 mA
<b>Switching output</b>	2 x PNP
<b>Number of switching outputs</b>	2
<b>Switching voltage</b>	Supply voltage [V DC] - 1 V DC
<b>Maximum switching current</b>	≤ 250 mA
<b>Switching delay</b>	0 s ... 50 s, programmable
<b>Setting accuracy of switching outputs</b>	+0.1 °C
<b>Temperature offset</b>	± 3 °C
<b>Display</b>	14-segment LED, blue, 4-digits, height 9 mm, Display electronically turnable by 180 °, update: 200 ms
<b>Rotatable housing</b>	Display against housing with electrical connection: 330 °, housing against process connection: 320 °
<b>Scaling of measuring range</b>	Zero point: max. +25 % of span Full scale: max. -25 % of span

### Mechanics/electronics

<b>Communication interface</b>	-
<b>Process connection</b>	Thread G ¼ A
<b>Seal</b>	NBR
<b>Insertion length/diameter of probe</b>	150 mm / 6 mm

<sup>1)</sup> At room temperature and when connected through thread.

<sup>2)</sup> For configurations with 2 switching outputs + one analog output.

<sup>3)</sup> The enclosure rating classes specified only apply while the thermometer is connected with female connectors that provide the corresponding enclosure rating.

<sup>4)</sup> IP enclosure rating as per IEC 60529.

<b>Wetted parts</b>	Stainless steel 1.4571 (AISI 316Ti)
<b>Maximum process pressure</b>	≤ 150 bar <sup>1)</sup>
<b>Housing material</b>	Stainless steel 1.4301 (AISI 304) Lower body PC + ABS Plastic head TPE-E Input keypad PC Display window
<b>Connection type</b>	Round connector M12 x 1, 5-pin <sup>2) 3)</sup>
<b>Enclosure rating</b>	IP65 <sup>4)</sup> IP67 <sup>4)</sup>
<b>Supply voltage</b>	15 V DC ... 35 V DC
<b>Maximum current consumption</b>	≤ 70 mA
<b>Total current consumption</b>	570 mA (incl. switching current) 320 mA
<b>Electrical safety</b>	Protection class: III, dielectric strength: 500 V, Overvoltage protection: 40 V DC, Short-circuit protection: Q <sub>A</sub> , Q <sub>1</sub> , Q <sub>2</sub> towards M, Reverse polarity protection: L <sup>+</sup> to M
<b>CE-conformity</b>	2004/108/EC, EN 61326-1 emission (group 1, class B) and interference immunity (industrial application)
<b>MTTF</b>	283 years

<sup>1)</sup> At room temperature and when connected through thread.

<sup>2)</sup> For configurations with 2 switching outputs + one analog output.

<sup>3)</sup> The enclosure rating classes specified only apply while the thermometer is connected with female connectors that provide the corresponding enclosure rating.

<sup>4)</sup> IP enclosure rating as per IEC 60529.

## Performance

<b>Accuracy of sensor element</b>	Class A according to IEC 60751 <sup>1) 2)</sup>
<b>Accuracy of switching output</b>	≤ ± 0.8 % of span
<b>Display accuracy</b>	≤ ± 0.8 % of span ± 1 digit
<b>Accuracy of analog output</b>	≤ ± 0.5 % of span
<b>Response time</b>	t <sub>50</sub> ≤ 5 s <sup>3)</sup> t <sub>90</sub> ≤ 10 s <sup>3)</sup>

<sup>1)</sup> ≤ ± (0.15 °C + 0.002 |t|).

<sup>2)</sup> |t| is the absolute value of the temperature in °C.

<sup>3)</sup> Depending on sensor configuration, according to IEC 60751.

## Ambient data

<b>Ambient temperature</b>	-20 °C ... +80 °C
<b>Storage and transport temperature</b>	-20 °C ... +80 °C
<b>Relative humidity</b>	45 % ... 75 %

## Certificates

<b>EU declaration of conformity</b>	✓
<b>UK declaration of conformity</b>	✓
<b>China RoHS</b>	✓
<b>cULus certificate</b>	✓

## Classifications

<b>ECLASS 5.0</b>	27200208
-------------------	----------

<b>ECLASS 5.1.4</b>	27200208
<b>ECLASS 6.0</b>	27200208
<b>ECLASS 6.2</b>	27200208
<b>ECLASS 7.0</b>	27200208
<b>ECLASS 8.0</b>	27200208
<b>ECLASS 8.1</b>	27200208
<b>ECLASS 9.0</b>	27200208
<b>ECLASS 10.0</b>	27200208
<b>ECLASS 11.0</b>	27200208
<b>ECLASS 12.0</b>	27200208
<b>ETIM 5.0</b>	EC002994
<b>ETIM 6.0</b>	EC002994
<b>ETIM 7.0</b>	EC002994
<b>ETIM 8.0</b>	EC002994
<b>UNSPSC 16.0901</b>	41112211

Dimensional drawing TBS with connection G 1/4 A according to DIN 3852-E

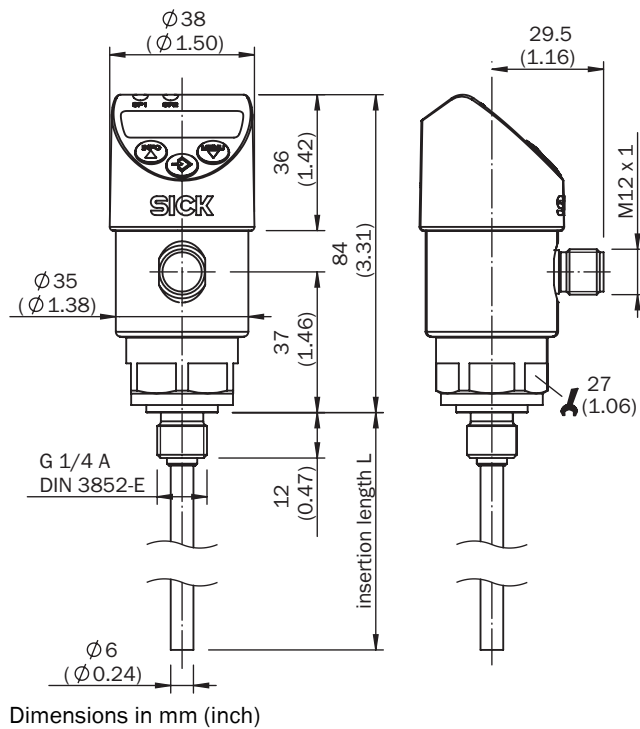







## Connection type



- ① L+
- ② Q<sub>2</sub>
- ③ M
- ④ Q<sub>1</sub>
- ⑤ Q<sub>A</sub>

## Recommended accessories

Other models and accessories → [www.sick.com/TBS](http://www.sick.com/TBS)

	Brief description	Type	part no.
connectors and cables			
	<ul style="list-style-type: none"> <li>• <b>Connection type head A:</b> Female connector, M12, 5-pin, straight, A-coded</li> <li>• <b>Connection type head B:</b> Flying leads</li> <li>• <b>Signal type:</b> Sensor/actuator cable</li> <li>• <b>Cable:</b> 2 m, 5-wire, PUR, halogen-free</li> <li>• <b>Description:</b> Sensor/actuator cable, unshielded</li> <li>• <b>Application:</b> Uncontaminated zones, Zones with oils and lubricants, Robot, Drag chain operation</li> </ul>	YF2A15-020UB5XLEAX	2095617
	<ul style="list-style-type: none"> <li>• <b>Connection type head A:</b> Female connector, M12, 5-pin, straight, A-coded</li> <li>• <b>Connection type head B:</b> Flying leads</li> <li>• <b>Signal type:</b> Sensor/actuator cable</li> <li>• <b>Cable:</b> 5 m, 5-wire, PUR, halogen-free</li> <li>• <b>Description:</b> Sensor/actuator cable, unshielded</li> <li>• <b>Application:</b> Uncontaminated zones, Zones with oils and lubricants, Robot, Drag chain operation</li> </ul>	YF2A15-050UB5XLEAX	2095618
	<ul style="list-style-type: none"> <li>• <b>Connection type head A:</b> Female connector, M12, 5-pin, straight, A-coded</li> <li>• <b>Connection type head B:</b> Flying leads</li> <li>• <b>Signal type:</b> Sensor/actuator cable</li> <li>• <b>Cable:</b> 2 m, 5-wire, PVC</li> <li>• <b>Description:</b> Sensor/actuator cable, unshielded</li> <li>• <b>Application:</b> Zones with chemicals, Uncontaminated zones</li> </ul>	YF2A15-020VB5XLEAX	2096239
	<ul style="list-style-type: none"> <li>• <b>Connection type head A:</b> Female connector, M12, 5-pin, straight, A-coded</li> <li>• <b>Connection type head B:</b> Flying leads</li> <li>• <b>Signal type:</b> Sensor/actuator cable</li> <li>• <b>Cable:</b> 5 m, 5-wire, PVC</li> <li>• <b>Description:</b> Sensor/actuator cable, unshielded</li> <li>• <b>Application:</b> Zones with chemicals, Uncontaminated zones</li> </ul>	YF2A15-050VB5XLEAX	2096240
	<ul style="list-style-type: none"> <li>• <b>Connection type head A:</b> Female connector, M12, 5-pin, straight, A-coded</li> <li>• <b>Connection type head B:</b> Flying leads</li> <li>• <b>Signal type:</b> Sensor/actuator cable</li> <li>• <b>Cable:</b> 0.6 m, 5-wire, PVC</li> <li>• <b>Description:</b> Sensor/actuator cable, unshielded</li> <li>• <b>Application:</b> Zones with chemicals, Uncontaminated zones</li> </ul>	YF2A15-C60VB5XLEAX	2145570
	<ul style="list-style-type: none"> <li>• <b>Connection type head A:</b> Female connector, M12, 5-pin, straight, A-coded</li> <li>• <b>Connection type head B:</b> Flying leads</li> <li>• <b>Signal type:</b> Sensor/actuator cable</li> <li>• <b>Cable:</b> 3 m, 5-wire, PVC</li> <li>• <b>Description:</b> Sensor/actuator cable, unshielded</li> <li>• <b>Application:</b> Zones with chemicals, Uncontaminated zones</li> </ul>	YF2A15-030VB5XLEAX	2145572

## SICK AT A GLANCE

SICK is one of the leading manufacturers of intelligent sensors and sensor solutions for industrial applications. A unique range of products and services creates the perfect basis for controlling processes securely and efficiently, protecting individuals from accidents and preventing damage to the environment.

We have extensive experience in a wide range of industries and understand their processes and requirements. With intelligent sensors, we can deliver exactly what our customers need. In application centers in Europe, Asia and North America, system solutions are tested and optimized in accordance with customer specifications. All this makes us a reliable supplier and development partner.

Comprehensive services complete our offering: SICK LifeTime Services provide support throughout the machine life cycle and ensure safety and productivity.

For us, that is “Sensor Intelligence.”

## WORLDWIDE PRESENCE:

Contacts and other locations –[www.sick.com](http://www.sick.com)