



# ER12-SB3C5

ER12

SAFETY COMMAND DEVICES

**SICK**  
Sensor Intelligence.



### Ordering information

Type	part no.
ER12-SB3C5	6045316

Other models and accessories → [www.sick.com/ER12](http://www.sick.com/ER12)



### Detailed technical data

#### Features

<b>N/O contacts</b>	1
<b>Reset pushbutton (illuminable)</b>	✓
<b>Actuation directions</b>	1
<b>Suitable for muting applications (with DMM4)</b>	✓
<b>Suitable for reset/override applications (with deTec4)</b>	✓
<b>Dimensions (W x H x D)</b>	40 mm x 123 mm x 36 mm
<b>Items supplied</b>	Including retaining clip, "RESET" cover and "RESET/OVERRIDE" cover

#### Safety-related parameters

<b>B<sub>10d</sub> parameter</b>	1 x 10 <sup>6</sup> switching cycles
----------------------------------	--------------------------------------

#### Functions

<b>Safe series connection</b>	None, only individual wiring (with diagnostics)
-------------------------------	---

#### Interfaces

<b>Connection type</b>	Plug connector, M12, 5-pin
Coupling nut material	PBT

#### Electronics - Operating data

<b>Protection class</b>	III (EN 61140)
<b>Switching principle</b>	Slow action switching element
<b>N/O contacts</b>	1
<b>Usage category</b>	DC-13 (EN 60947-5-1)
<b>Rated operating current (voltage)</b>	2 A (24 V DC)
<b>Contact material</b>	AgNi, 5 µm gold plated

<b>Electrical life</b>	
Reset pushbutton	1 x 10 <sup>6</sup> switching cycles

#### Electronics - Illumination

<b>Supply voltage V<sub>s</sub></b>	30 V AC/DC
<b>Power consumption</b>	14 mA (24 V DC)

#### Mechanics

<b>Dimensions</b>	40 mm x 123 mm x 36 mm
<b>Weight</b>	106 g
<b>Housing material</b>	PBT
<b>Mechanical life</b>	
Reset pushbutton	1 x 10 <sup>6</sup> switching cycles

#### Ambient data

<b>Enclosure rating</b>	IP65 (EN 60529)
<b>Ambient operating temperature</b>	-25 °C ... +70 °C
<b>Storage temperature</b>	-25 °C ... +80 °C

#### Certificates

<b>EU declaration of conformity</b>	✓
<b>UK declaration of conformity</b>	✓
<b>Moroccan declaration of conformity</b>	✓
<b>China RoHS</b>	✓
<b>cULus certificate</b>	✓
<b>ULus approval</b>	✓

#### Classifications

<b>ECLASS 5.0</b>	27379090
<b>ECLASS 5.1.4</b>	27371246
<b>ECLASS 6.0</b>	27371246
<b>ECLASS 6.2</b>	27371246
<b>ECLASS 7.0</b>	27371246
<b>ECLASS 8.0</b>	27371246
<b>ECLASS 8.1</b>	27371246
<b>ECLASS 9.0</b>	27371246
<b>ECLASS 10.0</b>	27371246
<b>ECLASS 11.0</b>	27371246
<b>ECLASS 12.0</b>	27371246
<b>ETIM 5.0</b>	EC000029
<b>ETIM 6.0</b>	EC000029
<b>ETIM 7.0</b>	EC000029
<b>ETIM 8.0</b>	EC000029
<b>UNSPSC 16.0901</b>	39122216

Dimensional drawing

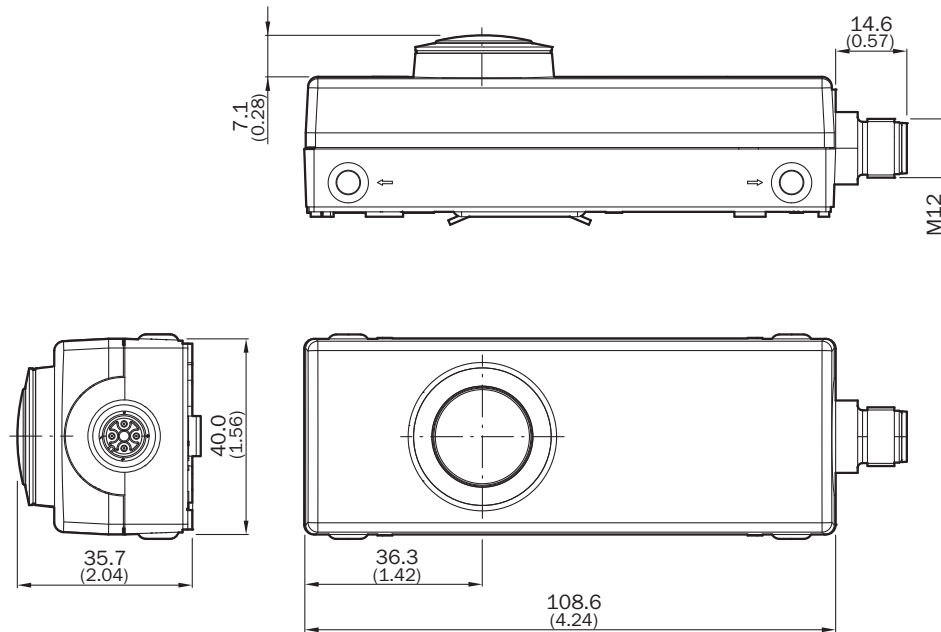

Dimensions in mm (inch)

Pinouts

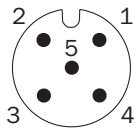

1	N/O contact
4	N/O contact
2	Not connected
3	LED -
5	LED +



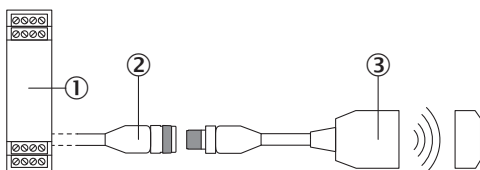





Connection single sensor



- ① Safe evaluation unit
- ② connecting cable with M12 female connector, 5-pin and flying leads (e.g., YF2A15-xxxVB5XLEAX)
- ③ ER12-SB3C5 reset pushbutton

## Recommended accessories

Other models and accessories → [www.sick.com/ER12](http://www.sick.com/ER12)

	Brief description	Type	part no.
connectors and cables			
	<ul style="list-style-type: none"> <li><b>Description:</b> Sensor/actuator cable, unshielded</li> <li><b>Connection type head A:</b> Female connector, M12, 5-pin, straight, A-coded</li> <li><b>Connection type head B:</b> Flying leads</li> <li><b>Signal type:</b> Sensor/actuator cable</li> <li><b>Cable:</b> 2 m, 5-wire, PVC</li> <li><b>Application:</b> Uncontaminated zones, Zones with chemicals</li> </ul>	YF2A15-020VB5XLEAX	2096239
	<ul style="list-style-type: none"> <li><b>Description:</b> Sensor/actuator cable, unshielded</li> <li><b>Connection type head A:</b> Female connector, M12, 5-pin, straight, A-coded</li> <li><b>Connection type head B:</b> Flying leads</li> <li><b>Signal type:</b> Sensor/actuator cable</li> <li><b>Cable:</b> 5 m, 5-wire, PVC</li> <li><b>Application:</b> Uncontaminated zones, Zones with chemicals</li> </ul>	YF2A15-050VB5XLEAX	2096240
	<ul style="list-style-type: none"> <li><b>Description:</b> Sensor/actuator cable, unshielded</li> <li><b>Connection type head A:</b> Female connector, M12, 5-pin, straight, A-coded</li> <li><b>Connection type head B:</b> Flying leads</li> <li><b>Signal type:</b> Sensor/actuator cable</li> <li><b>Cable:</b> 10 m, 5-wire, PVC</li> <li><b>Application:</b> Uncontaminated zones, Zones with chemicals</li> </ul>	YF2A15-100VB5XLEAX	2096241
	<ul style="list-style-type: none"> <li><b>Description:</b> Sensor/actuator cable, unshielded</li> <li><b>Connection type head A:</b> Female connector, M12, 5-pin, straight, A-coded</li> <li><b>Connection type head B:</b> Male connector, M12, 5-pin, straight, A-coded</li> <li><b>Signal type:</b> Sensor/actuator cable</li> <li><b>Cable:</b> 2 m, 5-wire, PUR, halogen-free</li> <li><b>Application:</b> Drag chain operation, Zones with oils and lubricants, Robot, Drag chain operation</li> </ul>	YF2A15-020UB5M2A15	2096009
	<ul style="list-style-type: none"> <li><b>Description:</b> Sensor/actuator cable, unshielded</li> <li><b>Connection type head A:</b> Female connector, M12, 5-pin, straight, A-coded</li> <li><b>Connection type head B:</b> Male connector, M12, 5-pin, straight, A-coded</li> <li><b>Signal type:</b> Sensor/actuator cable</li> <li><b>Cable:</b> 5 m, 5-wire, PUR, halogen-free</li> <li><b>Application:</b> Drag chain operation, Zones with oils and lubricants, Robot, Drag chain operation</li> </ul>	YF2A15-050UB5M2A15	2096010
	<ul style="list-style-type: none"> <li><b>Description:</b> Sensor/actuator cable, unshielded</li> <li><b>Connection type head A:</b> Female connector, M12, 5-pin, straight, A-coded</li> <li><b>Connection type head B:</b> Male connector, M12, 5-pin, straight, A-coded</li> <li><b>Signal type:</b> Sensor/actuator cable</li> <li><b>Cable:</b> 10 m, 5-wire, PUR, halogen-free</li> <li><b>Application:</b> Drag chain operation, Zones with oils and lubricants, Robot, Drag chain operation</li> </ul>	YF2A15-100UB5M2A15	2096011
	<ul style="list-style-type: none"> <li><b>Description:</b> Sensor/actuator cable, unshielded</li> <li><b>Connection type head A:</b> Female connector, M12, 5-pin, straight, A-coded</li> <li><b>Connection type head B:</b> Flying leads</li> <li><b>Signal type:</b> Sensor/actuator cable</li> <li><b>Cable:</b> 0.6 m, 5-wire, PVC</li> <li><b>Application:</b> Uncontaminated zones, Zones with chemicals</li> </ul>	YF2A15-C60VB5XLEAX	2145570
	<ul style="list-style-type: none"> <li><b>Description:</b> Sensor/actuator cable, unshielded</li> <li><b>Connection type head A:</b> Female connector, M12, 5-pin, straight, A-coded</li> <li><b>Connection type head B:</b> Flying leads</li> <li><b>Signal type:</b> Sensor/actuator cable</li> <li><b>Cable:</b> 3 m, 5-wire, PVC</li> <li><b>Application:</b> Uncontaminated zones, Zones with chemicals</li> </ul>	YF2A15-030VB5XLEAX	2145572

## SICK AT A GLANCE

SICK is one of the leading manufacturers of intelligent sensors and sensor solutions for industrial applications. A unique range of products and services creates the perfect basis for controlling processes securely and efficiently, protecting individuals from accidents and preventing damage to the environment.

We have extensive experience in a wide range of industries and understand their processes and requirements. With intelligent sensors, we can deliver exactly what our customers need. In application centers in Europe, Asia and North America, system solutions are tested and optimized in accordance with customer specifications. All this makes us a reliable supplier and development partner.

Comprehensive services complete our offering: SICK LifeTime Services provide support throughout the machine life cycle and ensure safety and productivity.

For us, that is “Sensor Intelligence.”

## WORLDWIDE PRESENCE:

Contacts and other locations –[www.sick.com](http://www.sick.com)