



LBV330-XXAGDT8MX0500

LBV3xx

LEVEL SENSORS

SICK
Sensor Intelligence.



Ordering information

| Type | part no. |
|----------------------|----------|
| LBV330-XXAGDT8MX0500 | 6042825 |

Other models and accessories → www.sick.com/LBV3xx

Illustration may differ



Detailed technical data

Features

| | |
|------------------------------|---------------------------|
| Medium | Bulk solids |
| Measurement | Switch |
| Probe type | Tuning fork |
| Probe length | 500 mm |
| Process pressure | -1 bar ... 25 bar |
| Process temperature | -50 °C ... +150 °C |
| Fill material density | ≥ 0.008 g/cm ³ |
| Particle size | < 10 mm |

Performance

| | |
|-----------------------------------|--|
| Accuracy of sensor element | ± 10 mm |
| Reproducibility | ≤ 5 mm |
| Response time | 500 ms ¹⁾ 1,000 ms ²⁾ |
| MTBF | 4,61*10 ⁶ h |

¹⁾ When covered.

²⁾ When uncovered.

Electronics

| | |
|--------------------------------|--------------------------------------|
| Communication interface | - |
| Supply voltage | 10 V DC ... 55 V DC |
| Residual ripple | ≤ 5 V _{pp} |
| Initialization time | < 2 s |
| VDE protection class 2 | ✓ |
| Connection type | M20 x 1.5 |
| Output signal | 1 x PNP/NPN |
| Electronics | Volt-free transistor output PNP/ NPN |
| Hysteresis | 10 mm |
| Output current | < 300 mA |

| | |
|-------------------------|--------------|
| Inductive load | ≤ 1 H |
| Capacitive load | 100 nF |
| Enclosure rating | IP66 IP67 |

Mechanics

| | |
|---------------------------|--|
| Wetted parts | Stainless steel 1.4404 / 316L |
| Process connection | G 1½ A PN 25 |
| Housing material | Stainless steel (electropolished) 316L |
| Sensor material | Stainless steel 1.4404 |

Ambient data

| | |
|--------------------------------------|-------------------|
| Ambient operating temperature | -40 °C ... +80 °C |
| Ambient temperature, storage | -40 °C ... +80 °C |

Certificates

| | |
|---------------------------------------|---|
| EU declaration of conformity | ✓ |
| UK declaration of conformity | ✓ |
| ACMA declaration of conformity | ✓ |
| China RoHS | ✓ |
| FDA certificate | ✓ |

Classifications

| | |
|-----------------------|----------|
| ECLASS 5.0 | 27273202 |
| ECLASS 5.1.4 | 27273202 |
| ECLASS 6.0 | 27273202 |
| ECLASS 6.2 | 27273202 |
| ECLASS 7.0 | 27273202 |
| ECLASS 8.0 | 27273202 |
| ECLASS 8.1 | 27273202 |
| ECLASS 9.0 | 27273202 |
| ECLASS 10.0 | 27273202 |
| ECLASS 11.0 | 27273202 |
| ECLASS 12.0 | 27273106 |
| ETIM 5.0 | EC002654 |
| ETIM 6.0 | EC002654 |
| ETIM 7.0 | EC002654 |
| ETIM 8.0 | EC002654 |
| UNSPSC 16.0901 | 41111938 |

Dimensional drawing LBV330 threaded version G 1½ A (DIN ISO 228/1)



Dimensions in mm (inch)

Dimensional drawing Temperature adapter

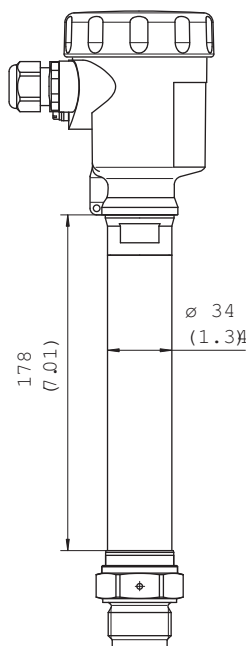

Dimensions in mm (inch)

Connection diagram NPN action

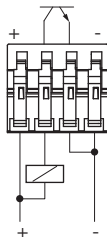

Connection diagram Transistor connection diagram

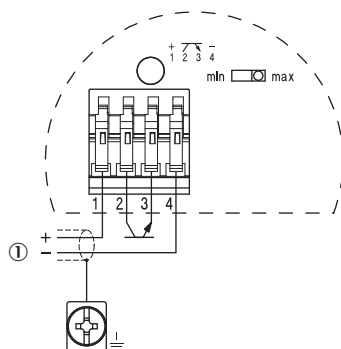

Connection diagram PNP action

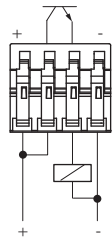

Instruction for installation Flow orientation of the tuning fork

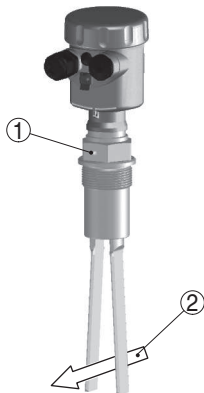

- ① Marking with screwed version
- ② Direction of flow

Instruction for installation Horizontal mounting

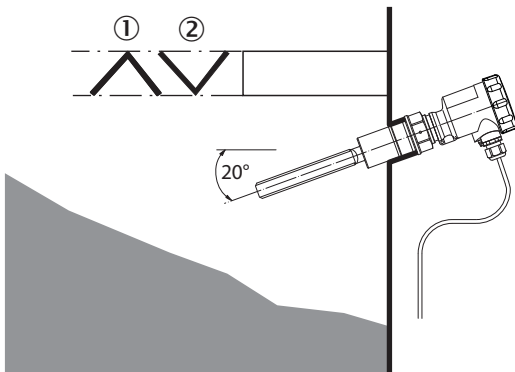

- ① Protective sheet
- ② Concave protective sheet for abrasive solids

Recommended accessories

Other models and accessories → www.sick.com/LBV3xx

| | Brief description | Type | part no. |
|---|---|---------------------|----------|
| Mounting systems | | | |
| | <ul style="list-style-type: none"> Description: Locking screw connection, process pressure -1 bar to 16 bar, process connection G 2 A, inner thread G 1 1/2 A Material: Stainless steel Details: Stainless steel 316L | BEF-MU-316G20-ALBV | 5322462 |
| Power supply units and power supply cables | | | |
|  | <ul style="list-style-type: none"> Description: Transistor (PNP/NPN): 10 V DC ... 55 V DC | ECD-RE-LB-VPNP-0001 | 6038667 |

SICK AT A GLANCE

SICK is one of the leading manufacturers of intelligent sensors and sensor solutions for industrial applications. A unique range of products and services creates the perfect basis for controlling processes securely and efficiently, protecting individuals from accidents and preventing damage to the environment.

We have extensive experience in a wide range of industries and understand their processes and requirements. With intelligent sensors, we can deliver exactly what our customers need. In application centers in Europe, Asia and North America, system solutions are tested and optimized in accordance with customer specifications. All this makes us a reliable supplier and development partner.

Comprehensive services complete our offering: SICK LifeTime Services provide support throughout the machine life cycle and ensure safety and productivity.

For us, that is “Sensor Intelligence.”

WORLDWIDE PRESENCE:

Contacts and other locations –www.sick.com