



# DOL-1205-W05MAC

Sensor-actuator cables

CONNECTORS AND CABLES

**SICK**  
Sensor Intelligence.



### Ordering information

Type	part no.
DOL-1205-W05MAC	6041751

Other models and accessories → [www.sick.com/Sensor-actuator\\_cables](http://www.sick.com/Sensor-actuator_cables)



### Detailed technical data

#### Technical specifications

<b>Connection type head A</b>	Female connector, M12, 5-pin, angled, A-coded
<b>Connection type head B</b>	Flying leads
<b>Connector material</b>	TPU
<b>Connector color</b>	Black
<b>Locking nut material</b>	Zinc die-cast, nickel-plated
<b>Tightening torque</b>	0.4 Nm
<b>Cable</b>	5 m, 5-wire, PUR, halogen-free
<b>Jacket material</b>	PUR, halogen-free
<b>Jacket color</b>	Black
<b>Cable diameter</b>	5.9 mm
<b>Conductor cross section</b>	0.34 mm <sup>2</sup>
<b>Shielding</b>	Shielded
<b>Bending radius</b>	
Flexible use	> 10 x cable diameter
Stationary position	> 5 x cable diameter
<b>Bending cycles</b>	≥ 4,000,000
<b>Reference voltage</b>	≤ 60 V
<b>Current loading</b>	4 A
<b>Traversing speed</b>	Max. 3 m/s
<b>Travelling distance</b>	10 m
<b>Acceleration</b>	≤ 10 m/s <sup>2</sup>
<b>Signal type</b>	HIPERFACE®
<b>Application</b>	Drag chain operation Zones with oils and lubricants
<b>Note</b>	Sensor/actuator cable
<b>Enclosure rating</b>	IP65/ IP67
<b>Operating temperature</b>	
Flexible use	-25 °C ... +80 °C
Stationary position	-40 °C ... +80 °C

Head	-25 °C ... +90 °C
------	-------------------

Certificates

EU declaration of conformity	✓
China RoHS	✓

Classifications

<b>ECLASS 5.0</b>	19030312
<b>ECLASS 5.1.4</b>	19030312
<b>ECLASS 6.0</b>	27060304
<b>ECLASS 6.2</b>	27060304
<b>ECLASS 7.0</b>	27060304
<b>ECLASS 8.0</b>	27060304
<b>ECLASS 8.1</b>	27060304
<b>ECLASS 9.0</b>	27060304
<b>ECLASS 10.0</b>	27060304
<b>ECLASS 11.0</b>	27060304
<b>ECLASS 12.0</b>	27060304
<b>ETIM 5.0</b>	EC000830
<b>ETIM 6.0</b>	EC000830
<b>ETIM 7.0</b>	EC003249
<b>ETIM 8.0</b>	EC003249
<b>UNSPSC 16.0901</b>	26121604

Dimensional drawing

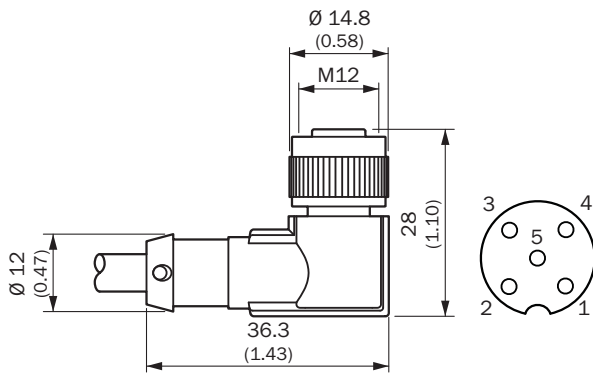

female connector M 12 x 1, angled, screened

Dimensions in mm (inch)

- ① Brown
- ② White
- ③ blue
- ④ Black
- ⑤ Gray

### PIN assignment

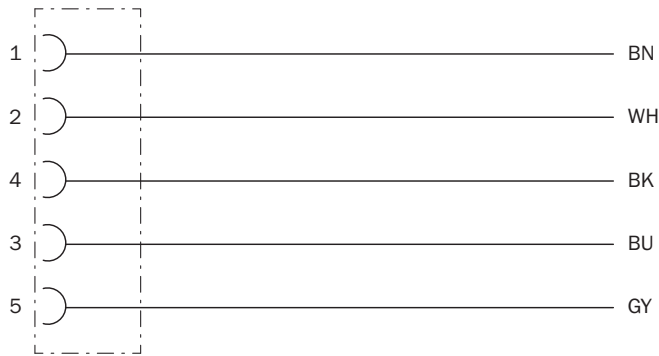

Contact assignment of the M12 female connector

## SICK AT A GLANCE

SICK is one of the leading manufacturers of intelligent sensors and sensor solutions for industrial applications. A unique range of products and services creates the perfect basis for controlling processes securely and efficiently, protecting individuals from accidents and preventing damage to the environment.

We have extensive experience in a wide range of industries and understand their processes and requirements. With intelligent sensors, we can deliver exactly what our customers need. In application centers in Europe, Asia and North America, system solutions are tested and optimized in accordance with customer specifications. All this makes us a reliable supplier and development partner.

Comprehensive services complete our offering: SICK LifeTime Services provide support throughout the machine life cycle and ensure safety and productivity.

For us, that is “Sensor Intelligence.”

## WORLDWIDE PRESENCE:

Contacts and other locations –[www.sick.com](http://www.sick.com)