



LFH-SB1X0G1AS25SZ0

LFH

LEVEL SENSORS

SICK
Sensor Intelligence.



Illustration may differ



Ordering information

Type	part no.
LFH-SB1X0G1AS25SZ0	6040953

Other models and accessories → www.sick.com/LFH

Detailed technical data

Features

Medium	Fluids
Measurement	Continuous
Process pressure	0 bar ... 1 bar
Process temperature	-10 °C ... +50 °C
Maximum ohmic load R_A	4 mA ... 20 mA, 2-wire, $R_A \leq (L^+ - 10 \text{ V}) / 0.02 \text{ A} - (0.14 \times \text{cable length in m}) [\text{Ohm}]$, 0 V ... 10 V, 3-wire optional with enhanced variant, $R_A > 100 \text{ kOhm}$, 0 V ... 5 V, 3-wire optional with enhanced variant, $R_A > 100 \text{ kOhm}$

Performance

Non-linearity	$\leq \pm 0.2 \%$, of span (Best Fit Straight Line, BFSL) according to IEC 61298-2
Accuracy of sensor element	$\leq \pm 0.5 \%$ of the span ^{1) 2)}
Non-repeatability	$\leq \pm 0.1 \%$ of the span
Long-term drift/one-year stability	$\leq \pm 0.2 \%$ of span (at reference conditions)
Temperature coefficient in rated temperature range	Mean TC of zero: $\leq 0.2 \%$ of span / 10 K (< 0.4 % for pressure ranges $\leq 0.25 \text{ bar}$) Mean TC of span $\leq 0.2 \%$ of span / 10 K
Rated temperature range	0 °C ... +50 °C
MTTF	403 years

¹⁾ Including non-linearity, hysteresis, zero point and full scale error (corresponds to error of measurement as per IEC 61298-2).

²⁾ Adjusted in vertical mounting position with pressure connection facing downwards.

Electronics

Communication interface	-
Supply voltage	10 V DC ... 30 V DC
Protection class III	✓
Connection type	PUR cable connection
Length of cable	25 m
Output signal	4 mA ... 20 mA, 2-wire
Enclosure rating	IP68
Dielectric strength	500 V DC, NEC Class O2 power supply (low voltage and low current max. 100 VA even in the event of a fault)

Electrical safety	Protection class: III, Short-circuit protection: Q _A towards M, Reverse polarity protection: L ⁺ to M, Surge protection: According to EN 61000-4-5 (1.5 J) optional for enhanced variant
EMC	EMC directive: 2014/30/EU, EN 61 326-2-3

Mechanics

Wetted parts	Stainless steel 1.4404 / 316L PA
Process connection	Without process connection
Housing material	Stainless steel 1.4404 / 316L
Material coaxial cable	PUR (tensile strength 1000 N), FEP optional available (tensile strength 500 N)
Weight	0.18 kg
Cable weight	0.08 kg/m

Ambient data

Ambient temperature, storage	-30 °C ... +80 °C
-------------------------------------	-------------------

Certificates

EU declaration of conformity	✓
UK declaration of conformity	✓
China RoHS	✓

Classifications

ECLASS 5.0	27200614
ECLASS 5.1.4	27200614
ECLASS 6.0	27200614
ECLASS 6.2	27200614
ECLASS 7.0	27200614
ECLASS 8.0	27200614
ECLASS 8.1	27200614
ECLASS 9.0	27200614
ECLASS 10.0	27200614
ECLASS 11.0	27200614
ECLASS 12.0	27200614
ETIM 5.0	EC011478
ETIM 6.0	EC011478
ETIM 7.0	EC011478
ETIM 8.0	EC011478
UNSPSC 16.0901	41111950



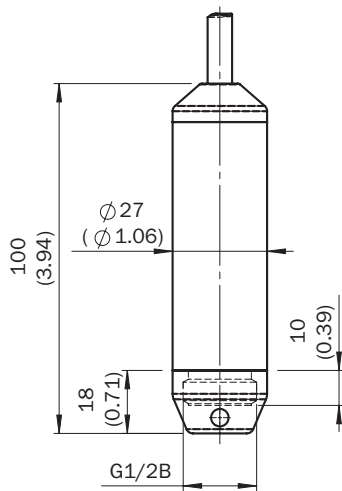

Dimensional drawing Standard version (Immersion depth up to 100 m)



Dimensions in mm (inch)

Recommended accessories

Other models and accessories → www.sick.com/LFH

	Brief description	Type	part no.
device protection and care			
	<ul style="list-style-type: none"> • Product family: Protection filter • Description: Protection filter for connection cable. Prevents humidity from entering the ventilation tube of the connection cable. For self-mounting at cable end. 	APR-VF-LFH001-0001	5324309
Mounting systems			
	<ul style="list-style-type: none"> • Description: Cable tension clamp for mounting the connection cable of the level sensor, max. tensile load = 2.5 kN (not to be used with FEP cable) • Material: Steel, plastic • Details: Steel, zinc coated, plastic 	BEF-CC-LFH001-0001	5324307
	<ul style="list-style-type: none"> • Description: Additional weight for stabilizing the LFH level sensor in moving liquids. Interior process connection G ½, is fastened to the level sensor instead of the protective cap. Weight: 500 g. • Material: Stainless steel • Details: Stainless steel 1.4571 	BEF-AW-LFHSST-0001	5324308
connectors and cables			
	<ul style="list-style-type: none"> • Items supplied: With integrated pressure compensation and terminal block • Note: Dimensions (W x D x H) 57 mm x 130 mm x 94 mm, for electrical connection of level probe LFH 	ASK-CB-LFH-PCO-0001	5324310

SICK AT A GLANCE

SICK is one of the leading manufacturers of intelligent sensors and sensor solutions for industrial applications. A unique range of products and services creates the perfect basis for controlling processes securely and efficiently, protecting individuals from accidents and preventing damage to the environment.

We have extensive experience in a wide range of industries and understand their processes and requirements. With intelligent sensors, we can deliver exactly what our customers need. In application centers in Europe, Asia and North America, system solutions are tested and optimized in accordance with customer specifications. All this makes us a reliable supplier and development partner.

Comprehensive services complete our offering: SICK LifeTime Services provide support throughout the machine life cycle and ensure safety and productivity.

For us, that is “Sensor Intelligence.”

WORLDWIDE PRESENCE:

Contacts and other locations –www.sick.com