



# LFBV330-XXGAVXMT0300

LFBV300

LEVEL SENSORS

**SICK**  
Sensor Intelligence.



Illustration may differ



### Ordering information

Type	part no.
LFV330-XXGAVXMT0300	6039666

Other models and accessories → [www.sick.com/LFV300](http://www.sick.com/LFV300)

### Detailed technical data

#### Features

<b>Measurement</b>	Switch
<b>Probe length</b>	300 mm
<b>Process pressure</b>	-1 bar ... 64 bar
<b>Process temperature</b>	-50 °C ... +150 °C
<b>Fill material density</b>	0.5 g/cm <sup>3</sup> ... 2.5 g/cm <sup>3</sup>

#### Performance

<b>Accuracy of sensor element</b>	± 2 mm
<b>Reproducibility</b>	≤ 1 mm
<b>Viscosity</b>	0.1 mPas ... 10,000 mPas
<b>Response time</b>	500 ms
<b>MTBF</b>	9,73*10 <sup>6</sup> h

#### Electronics

<b>Communication interface</b>	-
<b>Supply voltage</b>	10 V DC ... 55 V DC
<b>Residual ripple</b>	≤ 5 V <sub>pp</sub>
<b>Power consumption</b>	< 10 mA
<b>Initialization time</b>	< 2 s
<b>VDE protection class 2</b>	✓
<b>Connection type</b>	M20 x 1.5
<b>Output signal</b>	1 x PNP/NPN
<b>Electronics</b>	Volt-free transistor output PNP/ NPN
<b>Hysteresis</b>	2 mm
<b>Output current</b>	< 300 mA
<b>Inductive load</b>	≤ 1 H
<b>Capacitive load</b>	100 nF
<b>Enclosure rating</b>	IP66 / IP67

<b>Temperature drift</b>	0.03 mm/K
--------------------------	-----------

Mechanics

<b>Wetted parts</b>	Stainless steel 316L (optional Ra ≤ 0.8 µm)
<b>Process connection</b>	G 1 A PN 64
<b>Housing material</b>	Aluminum
<b>Sensor material</b>	Stainless steel 1.4404

Ambient data

<b>Ambient operating temperature</b>	-40 °C ... +70 °C
<b>Ambient temperature, storage</b>	-40 °C ... +80 °C

Certificates

<b>EU declaration of conformity</b>	✓
<b>UK declaration of conformity</b>	✓
<b>ACMA declaration of conformity</b>	✓
<b>China RoHS</b>	✓
<b>FDA certificate</b>	✓

Classifications

<b>ECLASS 5.0</b>	27273202
<b>ECLASS 5.1.4</b>	27273202
<b>ECLASS 6.0</b>	27273202
<b>ECLASS 6.2</b>	27273202
<b>ECLASS 7.0</b>	27273202
<b>ECLASS 8.0</b>	27273202
<b>ECLASS 8.1</b>	27273202
<b>ECLASS 9.0</b>	27273202
<b>ECLASS 10.0</b>	27273202
<b>ECLASS 11.0</b>	27273202
<b>ECLASS 12.0</b>	27273106
<b>ETIM 5.0</b>	EC002654
<b>ETIM 6.0</b>	EC002654
<b>ETIM 7.0</b>	EC002654
<b>ETIM 8.0</b>	EC002654
<b>UNSPSC 16.0901</b>	41111938

### Dimensional drawing Marking on the welded flange



Dimensions in mm (inch)  
 ① Marking

### Dimensional drawing LFV330



Dimensions in mm (inch)  
 ① Thread  
 ② Tri-Clamp  
 ③ DN 25 cone  
 ④ Bolting D 40  
 ⑤ Flange  
 ⑥ Gas-tight leadthrough  
 ⑦ Temperature adapter

Connection diagram Transistor - electronic module

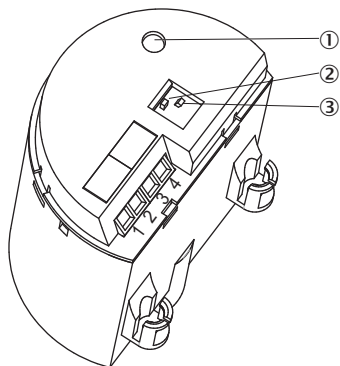

- ① Signal lamp (LED)
- ② DIL switch for mode adjustment
- ③ DIL-switch for sensitivity adjustment

Connection diagram NPN action

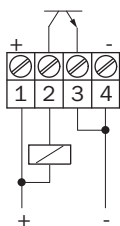

Connection diagram PNP action

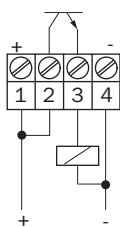

Instruction for installation Inflowing medium

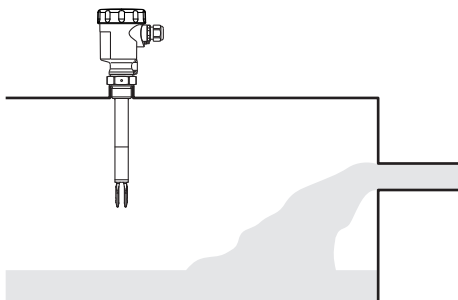





### Characteristic curve Influence of the process temperature on the switching point

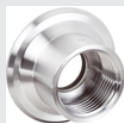

- ① Shifting of the switching point in mm (in)
- ② Process temperature in °C (°F)
- ③ Switching point at reference conditions (notch)
- ④ Tuning fork

### Recommended accessories

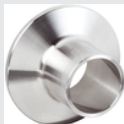
Other models and accessories → [www.sick.com/LFV300](http://www.sick.com/LFV300)

	Brief description	Type	part no.
<b>Mounting systems</b>			
	<ul style="list-style-type: none"> <li><b>Description:</b> Lock nut fitting, process pressure -1 bar to 64 bar, G 1 A process connection, G 3/4 A female thread</li> <li><b>Material:</b> Stainless steel</li> <li><b>Details:</b> Stainless steel 316L</li> </ul>	BEF-MU-316G10-ALFV	5322463
	<ul style="list-style-type: none"> <li><b>Description:</b> Welded flange/welded connector, process connection G 1</li> <li><b>Material:</b> Stainless steel</li> <li><b>Details:</b> Stainless steel 1.4404</li> </ul>	BEF-FL-GEWG10-LFV2	4054605
	<ul style="list-style-type: none"> <li><b>Description:</b> Welded flange/welded connector, G 3/4 process connection</li> <li><b>Material:</b> Stainless steel</li> <li><b>Details:</b> Stainless steel 1.4404</li> </ul>	BEF-FL-GEWG34-LFV2	4054604
	<ul style="list-style-type: none"> <li><b>Description:</b> Welded flange/welded connector, process connection Tri-Clamp 1"</li> <li><b>Material:</b> Stainless steel</li> <li><b>Details:</b> Stainless steel 1.4404</li> </ul>	BEF-FL-TCL110-LFV2	5321678
	<ul style="list-style-type: none"> <li><b>Description:</b> Welded flange/welded connector, process connection Tri-Clamp 2"</li> <li><b>Material:</b> Stainless steel</li> <li><b>Details:</b> Stainless steel 1.4404</li> </ul>	BEF-FL-TCL120-LFV2	5321679
	<ul style="list-style-type: none"> <li><b>Description:</b> Welded flange/welded connector, DIN11851-1, DN25 / PN40</li> <li><b>Material:</b> Stainless steel</li> <li><b>Details:</b> Stainless steel 1.4404</li> </ul>	BEF-FL-851D25-LFV2	5321527
<b>Power supply units and power supply cables</b>			
	<ul style="list-style-type: none"> <li><b>Description:</b> Transistor (PNP/NPN): 10 V DC ... 55 V DC</li> </ul>	ECD-RE-LFVP-NP-0001	6038672

## SICK AT A GLANCE

SICK is one of the leading manufacturers of intelligent sensors and sensor solutions for industrial applications. A unique range of products and services creates the perfect basis for controlling processes securely and efficiently, protecting individuals from accidents and preventing damage to the environment.

We have extensive experience in a wide range of industries and understand their processes and requirements. With intelligent sensors, we can deliver exactly what our customers need. In application centers in Europe, Asia and North America, system solutions are tested and optimized in accordance with customer specifications. All this makes us a reliable supplier and development partner.

Comprehensive services complete our offering: SICK LifeTime Services provide support throughout the machine life cycle and ensure safety and productivity.

For us, that is “Sensor Intelligence.”

## WORLDWIDE PRESENCE:

Contacts and other locations –[www.sick.com](http://www.sick.com)