



Illustration may differ



Ordering information

| Type | part no. |
|--------------|----------|
| OD2-N50W10U2 | 6036585 |

Other models and accessories → www.sick.com/OD_Value

Detailed technical data

Features

| | |
|---------------------------------|--|
| Measuring range | 40 mm ... 60 mm ¹⁾ |
| Repeatability | 5 μm ^{2) 3) 4)} |
| Linearity | ± 20 μm ^{2) 3) 5)} |
| Response time | ≥ 1 ms |
| Measuring frequency | ≤ 2 kHz ¹⁾ |
| Output time | ≥ 0.5 ms |
| Emitted beam | |
| Light source | Laser, red |
| Typ. light spot size (distance) | 0.5 mm x 1 mm (50 mm) |
| Key laser figures | |
| Normative reference | IEC 60825-1:2014, EN 60825-1:2014 |
| Laser class | 2 ⁶⁾ |
| | 7) |
| Additional function | Mean-value setting 1 ... 64x Automatic sensitivity adjustment Analog outputs can be taught in Invertable analog output Teach-in of digital output Invertable switching output Multifunctional input: laser-off / external teach-in / trigger |

¹⁾ 6% ... 90% remission factor.

²⁾ Measurement on 90 % remission (ceramic, white).

³⁾ At averaging function medium.

⁴⁾ Constant ambient conditions.

⁵⁾ When calibrated in the application regularly.

⁶⁾ Wavelength: 655 nm, max. output: 1 mW.

⁷⁾ Do not intentionally look into the laser beam. Never point the laser beam at people's eyes.

| | | |
|----------------------------------|-------------------|--|
| Safety-related parameters | | Switching mode: distance to object (DtO) Switching mode: window (Wnd) |
| | MTTF _D | 101 years |
| | DC _{avg} | 0% |

- 1) 6% ... 90% remission factor.
- 2) Measurement on 90 % remission (ceramic, white).
- 3) At averaging function medium.
- 4) Constant ambient conditions.
- 5) When calibrated in the application regularly.
- 6) Wavelength: 655 nm, max. output: 1 mW.
- 7) Do not intentionally look into the laser beam. Never point the laser beam at people's eyes.

Interfaces

| | | |
|-----------------------------------|---------------------------------------|--------------------------|
| Digital output | Number | 2 ¹⁾ |
| | Type | NPN |
| | Maximum output current I _A | ≤ 100 mA |
| | Analog output | |
| | Number | 1 |
| | Type | Voltage output |
| | Voltage | 0 V ... 10 V, > 10,000 Ω |
| | Resolution | 16 bit |
| Multifunctional input (MF) | | 1 x MF ²⁾ |

- 1) PNP: HIGH = V_S - (< 2 V) / LOW = < 2 V; NPN: HIGH = < 2 V / LOW = V_S.
- 2) MF can be used as laser-off, trigger, external teach-in, or deactivated; response time ≤ 3 ms.

Electronics

| | |
|-------------------------------------|---|
| Supply voltage U_B | DC 18 V ... 24 V |
| Power consumption | ≤ 2.88 W ¹⁾ |
| Warm-up time | ≤ 30 min |
| Display | Distance bar graph, up to 8 status LEDs |
| Enclosure rating | IP67 |
| Protection class | III |
| Connection type | Cable, 2 m |

- 1) Without load, with current output.

Mechanics

| | |
|-------------------------------|-------------------------|
| Dimensions (W x H x D) | 20.4 mm x 60 mm x 50 mm |
| Housing material | Plastic (PBT) |
| Window material | Plastic (PMMA) |
| Weight | 70 g |

Ambient data

| | |
|---------------------------------------|-------------------|
| Ambient temperature, operation | -10 °C ... +40 °C |
|---------------------------------------|-------------------|

| | |
|---|---|
| Ambient temperature, storage | -20 °C ... +60 °C |
| Relative air humidity (non-condensing) | 35 % ... 95 % |
| Temperature drift | ± 0.08 % FS/K (FS = Full Scale = Measuring range of sensor) |
| Typ. Ambient light immunity | Artificial light: ≤ 3,000 lx Sunlight: ≤ 10,000 lx |
| Vibration resistance | 10 Hz ... 55 Hz (amplitude 1.5 mm, x-, y-, z-axis 2 hours each) |
| Shock resistance | 50 G (x, y, z axis 3 times each) |

Certificates

| | |
|--|---|
| EU declaration of conformity | ✓ |
| UK declaration of conformity | ✓ |
| ACMA declaration of conformity | ✓ |
| Moroccan declaration of conformity | ✓ |
| China RoHS | ✓ |
| Information according to Art. 3 of Data Act (Regulation EU 2023/2854) | ✓ |

Classifications

| | |
|-----------------------|----------|
| ECLASS 5.0 | 27270801 |
| ECLASS 5.1.4 | 27270801 |
| ECLASS 6.0 | 27270801 |
| ECLASS 6.2 | 27270801 |
| ECLASS 7.0 | 27270801 |
| ECLASS 8.0 | 27270801 |
| ECLASS 8.1 | 27270801 |
| ECLASS 9.0 | 27270801 |
| ECLASS 10.0 | 27270801 |
| ECLASS 11.0 | 27270801 |
| ECLASS 12.0 | 27270916 |
| ETIM 5.0 | EC001825 |
| ETIM 6.0 | EC001825 |
| ETIM 7.0 | EC001825 |
| ETIM 8.0 | EC001825 |
| UNSPSC 16.0901 | 41111613 |

Dimensional drawing OD2-x50W10xx

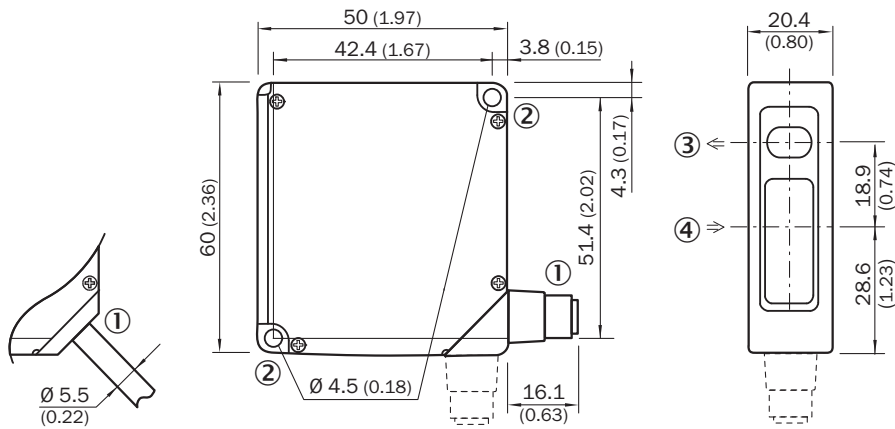

Dimensions in mm (inch)

- ① 2 m cable or M12 connector; 90° rotatable
- ② Mounting hole, Ø 4.5 mm
- ③ optical axis, sender
- ④ optical axis, receiver

Connection type OD2-xxxxxA2 OD2-xxxxxC2 OD2-xxxxxI2 OD2-xxxxxU2 cable

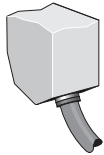

Connection diagram

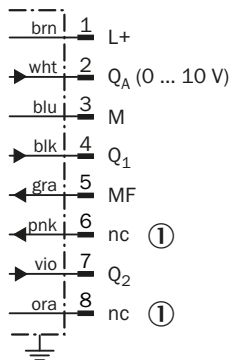

① Not assigned

Adjustment possible OD2-xxxxxxUx

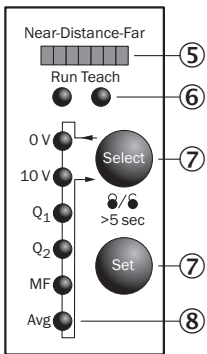

- ⑤ Distance indicator
- ⑥ mode indicator (Run/Teach)
- ⑦ Control elements
- ⑧ status indicator in- and outputs (Run-mode)/menu indicator (Teach-mode)

Light spot size OD2-x50W10xx

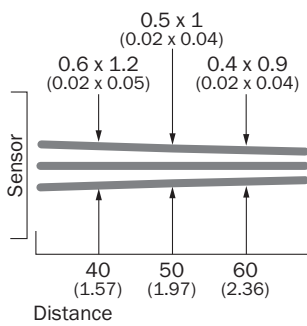

All dimensions in mm (inch)

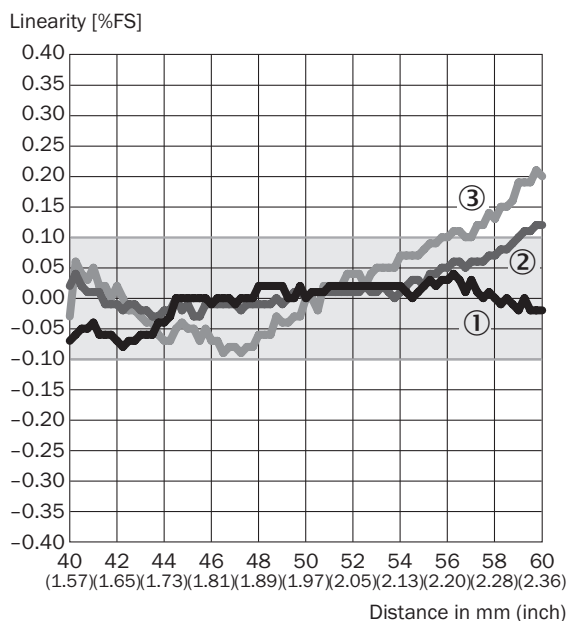

Linearity OD2-x50xxxx



- ① White ceramic
- ② Black paper
- ③ stainless steel

Recommended accessories

Other models and accessories → www.sick.com/OD_Value

| | Brief description | Type | part no. |
|---|---|----------------|----------|
| connectors and cables | | | |
|  | <ul style="list-style-type: none"> Description: Sensor/actuator cable, special color code, shielded Connection type head A: Female connector, M12, 8-pin, straight Connection type head B: Flying leads Signal type: Sensor/actuator cable Cable: 2 m, 8-wire, PVC Connection systems: Flying leads Application: Uncontaminated zones, Zones with chemicals | DOL-1208-G02MF | 6020663 |
| Mounting systems | | | |
|  | <ul style="list-style-type: none"> Description: Stainless-steel mounting bracket Material: Stainless steel Details: Stainless steel | BEF-WN-OD1000 | 4089813 |

SICK AT A GLANCE

SICK is one of the leading manufacturers of intelligent sensors and sensor solutions for industrial applications. A unique range of products and services creates the perfect basis for controlling processes securely and efficiently, protecting individuals from accidents and preventing damage to the environment.

We have extensive experience in a wide range of industries and understand their processes and requirements. With intelligent sensors, we can deliver exactly what our customers need. In application centers in Europe, Asia and North America, system solutions are tested and optimized in accordance with customer specifications. All this makes us a reliable supplier and development partner.

Comprehensive services complete our offering: SICK LifeTime Services provide support throughout the machine life cycle and ensure safety and productivity.

For us, that is “Sensor Intelligence.”

WORLDWIDE PRESENCE:

Contacts and other locations –www.sick.com