



VSE18L-4N344

V18

PHOTOELECTRIC SENSORS

SICK
Sensor Intelligence.



Illustration may differ



Ordering information

Type	part no.
VSE18L-4N344	6027937

Other models and accessories → www.sick.com/V18

Detailed technical data

Features

Functional principle	Through-beam photoelectric sensor
Dimensions (W x H x D)	18 mm x 18 mm x 107.7 mm
Housing design (light emission)	Cylindrical
Housing length	107.7 mm
Thread diameter (housing)	M18 x 1
Optical axis	Radial
Sensing range max.	0 m ... 60 m
Sensing range	0 m ... 50 m
Focus	0.06°
Type of light	Visible red light
Light source	Laser ¹⁾
Light spot size (distance)	Ø 40 mm (50 m)
Angle of dispersion	0.06°
Wave length	650 nm
Laser class	1 (IEC 60825-1) ²⁾
Laser power output	0.4 mW
Adjustment	Potentiometer, 270° (Sensitivity)
Special applications	Detecting small objects

¹⁾ Average service life: 100,000 h at T_J = +25 °C.

²⁾ Do not intentionally look into the laser beam. Never point the laser beam at people's eyes.

Mechanics/electronics

Supply voltage U_B	10 V DC ... 30 V DC ¹⁾
Ripple	$\pm 10\%$ ²⁾
Current consumption	25 mA ³⁾
Switching output	NPN
Switching mode	Light/dark switching
Switching mode selector	Selectable via L/D control cable
Output current I_{max}	≤ 100 mA
Response time	≤ 0.5 ms ⁴⁾
Switching frequency	1,000 Hz ⁵⁾
Angle of reception	0.08°
Connection type	Male connector M12, 4-pin
Circuit protection	A ⁶⁾ B ⁷⁾ C ⁸⁾ D ⁹⁾
Protection class	III
Weight	120 g
Housing material	Metal, Nickel-plated brass/PC
Optics material	Plastic, PC with protective glass pane
Enclosure rating	IP67
Test input sender off	TE to 0 V
Ambient operating temperature	-15 °C ... +55 °C
Ambient temperature, storage	-25 °C ... +70 °C
UL File No.	NRKH.E181493, CDRH-conform (0312012-00)

¹⁾ Limit values.

²⁾ May not fall below or exceed U_y tolerances.

³⁾ Without load.

⁴⁾ Signal transit time with resistive load.

⁵⁾ With light/dark ratio 1:1.

⁶⁾ A = V_S connections reverse-polarity protected.

⁷⁾ B = inputs and output reverse-polarity protected.

⁸⁾ C = interference suppression.

⁹⁾ D = outputs overcurrent and short-circuit protected.

Certificates

EU declaration of conformity	✓
China RoHS	✓
cULus certificate	✓

Classifications

ECLASS 5.0	27270901
ECLASS 5.1.4	27270901
ECLASS 6.0	27270901
ECLASS 6.2	27270901

ECLASS 7.0	27270901
ECLASS 8.0	27270901
ECLASS 8.1	27270901
ECLASS 9.0	27270901
ECLASS 10.0	27270901
ECLASS 11.0	27270901
ECLASS 12.0	27270901
ETIM 5.0	EC002716
ETIM 6.0	EC002716
ETIM 7.0	EC002716
ETIM 8.0	EC002716
UNSPSC 16.0901	39121528

Connection type



Connection diagram Cd-219

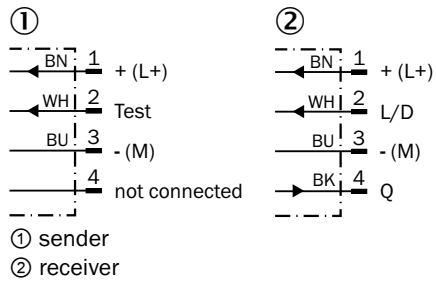

Characteristic curve

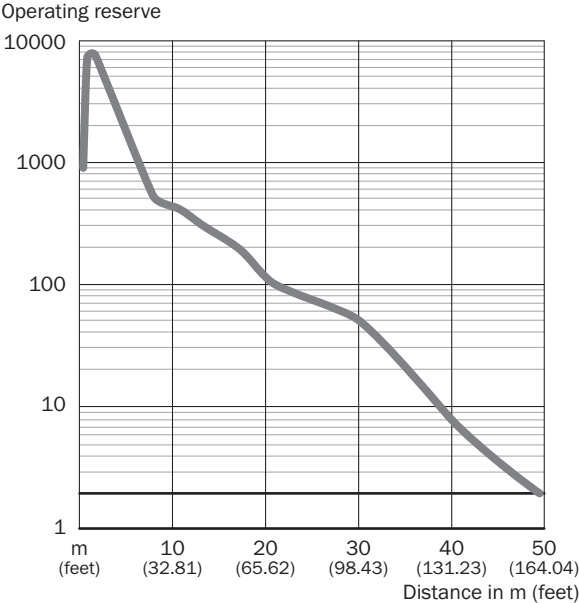

Light spot size VSE18L

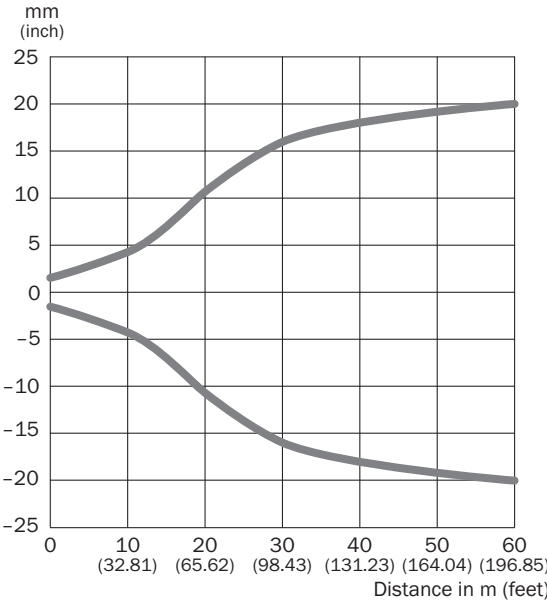

Sensing range diagram VSE18L

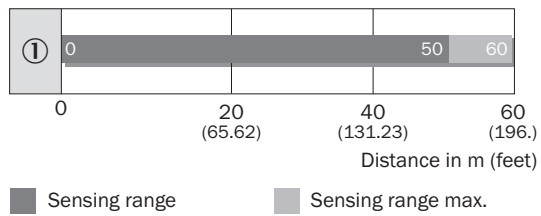

Dimensional drawing Radial

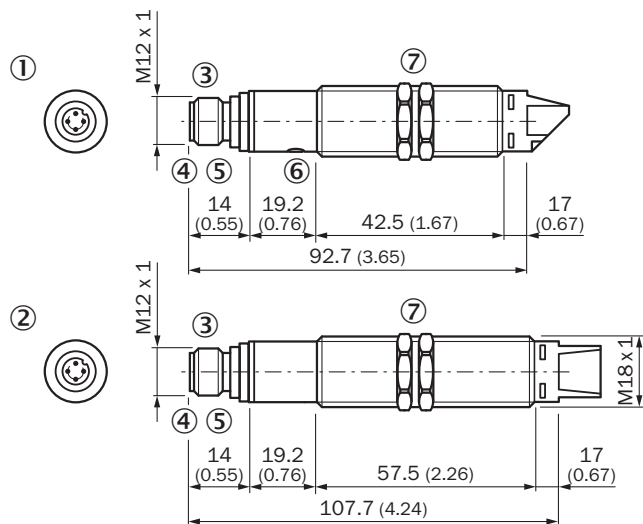



Dimensions in mm (inch)

- ① sender
- ② receiver
- ③ M12 male device connector, 4-pin
- ④ Sensitivity setting: single teach-in button
- ⑤ green LED indicator: V_S supply voltage feed
- ⑥ Yellow LED indicator:
- ⑥ - lights continuously:
- ⑥ - reception signal > reserve factor 2
- ⑥ - blinks: Reception signal < reserve factor 2 but > switching threshold 1
- ⑦ fastening nuts (2 x); width across 24, metal
- ⑦ (included with delivery)

Recommended accessories

Other models and accessories → www.sick.com/V18

	Brief description	Type	part no.
connectors and cables			
	<ul style="list-style-type: none"> Description: Sensor/actuator cable, unshielded Connection type head A: Female connector, M12, 4-pin, straight, A-coded Connection type head B: Flying leads Signal type: Sensor/actuator cable Cable: 5 m, 4-wire, PVC Application: Uncontaminated zones, Zones with chemicals 	YF2A14-050VB3XLEAX	2096235
	<ul style="list-style-type: none"> Description: Unshielded Connection type head A: Male connector, M12, 4-pin, straight, A-coded Connection systems: Screw-type terminals Permitted cross-section: ≤ 0.75 mm² 	STE-1204-G	6009932
Mounting systems			
	<ul style="list-style-type: none"> Description: Mounting bracket for M18 sensors Material: Steel Details: Steel, zinc coated Items supplied: Without mounting hardware Suitable for: GR18, V180-2, V18, W15, Z1, Z2 	BEF-WN-M18	5308446

SICK AT A GLANCE

SICK is one of the leading manufacturers of intelligent sensors and sensor solutions for industrial applications. A unique range of products and services creates the perfect basis for controlling processes securely and efficiently, protecting individuals from accidents and preventing damage to the environment.

We have extensive experience in a wide range of industries and understand their processes and requirements. With intelligent sensors, we can deliver exactly what our customers need. In application centers in Europe, Asia and North America, system solutions are tested and optimized in accordance with customer specifications. All this makes us a reliable supplier and development partner.

Comprehensive services complete our offering: SICK LifeTime Services provide support throughout the machine life cycle and ensure safety and productivity.

For us, that is “Sensor Intelligence.”

WORLDWIDE PRESENCE:

Contacts and other locations –www.sick.com