



# ISD300-1112

ISD300

OPTICAL DATA TRANSMISSION

**SICK**  
Sensor Intelligence.



Illustration may differ



## Ordering information

| Type        | part no. |
|-------------|----------|
| ISD300-1112 | 6024837  |

Other models and accessories → [www.sick.com/ISD300](http://www.sick.com/ISD300)

## Detailed technical data

### Features

|                                      |                           |
|--------------------------------------|---------------------------|
| <b>Product segment</b>               | Optical data transmission |
| <b>Product</b>                       | ISD300                    |
| <b>Housing material</b>              | Metal                     |
| <b>Enclosure rating</b>              | IP65                      |
| <b>Power consumption</b>             | ≤ 0.2 A                   |
| <b>Ambient operating temperature</b> | -5 °C ... +50 °C          |
| <b>Storage temperature</b>           | -30 °C ... +70 °C         |
| <b>Relative humidity</b>             | 90 %, Non-condensing      |

### Mechanics/electronics

|  |                  |
|--|------------------|
| <b>Supply voltage <math>V_s</math></b> | DC 18 V ... 30 V |
| <b>Transmission range</b>              | 0.2 m 120 m      |
| <b>Connection type</b>                 | Terminals        |
| <b>Current consumption</b>             | ≤ 0.2 A          |
| <b>Frequency</b>                       | F2 <sup>1)</sup> |
| <b>Enclosure rating</b>                | IP65             |
| <b>Protection class</b>                | I                |

<sup>1)</sup> A pair of devices with numbers ending in 1 and 2 are required to create a data transfer section.

### Performance

|  |                        |
|--|------------------------|
| <b>Transmission range</b>              | 0.2 m ... 120 m        |
| <b>Light source</b>                    | LED, infrared (880 nm) |
| <b>Typ. light spot size (distance)</b> | 1.75 m (at 100 m)      |
| <b>Aperture angle</b>                  | Ca. ± 0.5°             |

### Interfaces

|                    |           |
|--------------------|-----------|
| <b>PROFIBUS DP</b> | ✓, RS-485 |
|--------------------|-----------|

<sup>1)</sup> 0 V ... 2 V: interference-free operation.

<sup>2)</sup>  $V_s - 2$  V: reduced system reserve.

|                       |                        |                                 |
|-----------------------|------------------------|---------------------------------|
|                       | Data transmission rate | 1.5 Mbit/s                      |
| <b>Serial</b>         |                        | ✓                               |
|                       | Data transmission rate | 1.5 Mbit/s                      |
| <b>Digital input</b>  |                        | 0 V ... 2 V: sender deactivated |
| <b>Digital output</b> |                        |                                 |
|                       | Number                 | 1 <sup>1) 2)</sup>              |
| <b>Signal delay</b>   |                        | ≤ 1.5 μs, + 1 Tbit              |

<sup>1)</sup> 0 V ... 2 V: interference-free operation.

<sup>2)</sup>  $V_S - 2 V$ : reduced system reserve.

### Ambient data

|  |                              |
|--|------------------------------|
| <b>Electromagnetic compatibility (EMC)</b> | EN 61000-6-2<br>EN 61000-6-4 |
| <b>Ambient temperature, operation</b>      | -5 °C ... +50 °C             |
| <b>Ambient temperature, storage</b>        | -30 °C ... +70 °C            |
| <b>Max. rel. humidity (not condensing)</b> | 90 %, Non-condensing         |

### General notes

|             |  |
|-------------|--|
| <b>Note</b> | 2 devices are required to construct a data transmission path: ISD300-xxx1 (frequency 1) and ISD300-xxx2 (frequency 2). The two devices must be ordered separately. |
|-------------|--|

### Classifications

|                       |          |
|-----------------------|----------|
| <b>ECLASS 5.0</b>     | 19039001 |
| <b>ECLASS 5.1.4</b>   | 19039001 |
| <b>ECLASS 6.0</b>     | 19179090 |
| <b>ECLASS 6.2</b>     | 19179090 |
| <b>ECLASS 7.0</b>     | 19179090 |
| <b>ECLASS 8.0</b>     | 19179090 |
| <b>ECLASS 8.1</b>     | 19179090 |
| <b>ECLASS 9.0</b>     | 19179090 |
| <b>ETIM 5.0</b>       | EC000515 |
| <b>ETIM 6.0</b>       | EC000515 |
| <b>UNSPSC 16.0901</b> | 43201404 |

### Certificates

|                                       |   |
|---------------------------------------|---|
| <b>EU declaration of conformity</b>   | ✓ |
| <b>UK declaration of conformity</b>   | ✓ |
| <b>ACMA declaration of conformity</b> | ✓ |
| <b>China RoHS</b>                     | ✓ |

Dimensional drawing: DSC-1608-1208

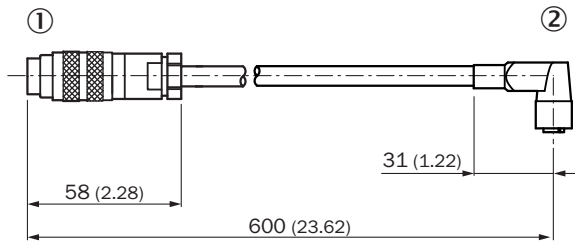

- Dimensions in mm (inch)  
 ① Connector M16, 8-pin  
 ② male connector M12, 8-pin

Dimensional drawing ISD300 RS-485/PROFIBUS, ISD300 RS-422/Interbus, ISD300 DH+/RIO, ISD300 DeviceNet/CANopen

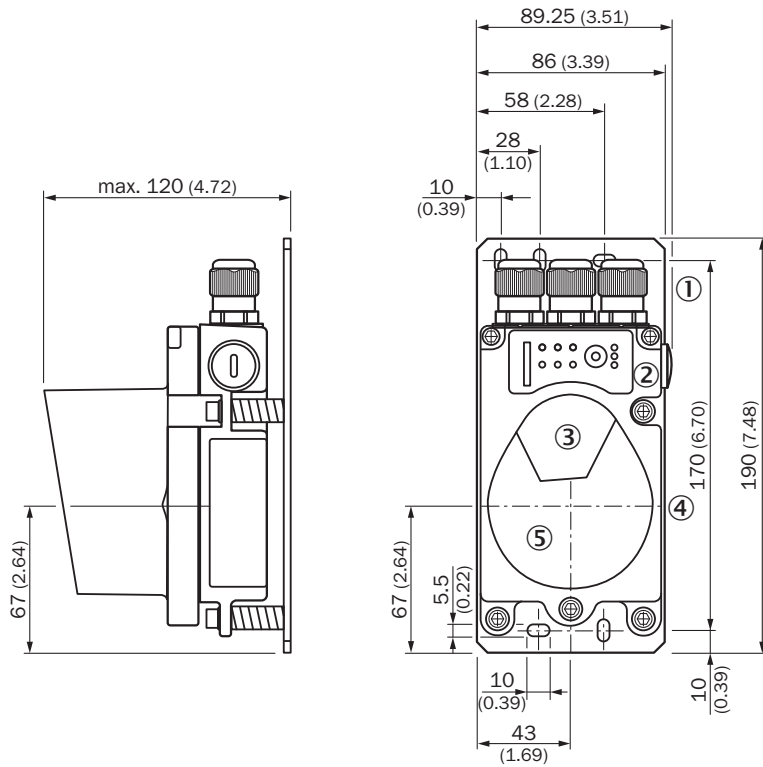

- Dimensions in mm (inch)  
 ① M16 gland  
 ② Control panel  
 ③ Sender lens  
 ④ Center of optical axis  
 ⑤ Receiver lens

### Connection type ISD300 RS-485/PROFIBUS

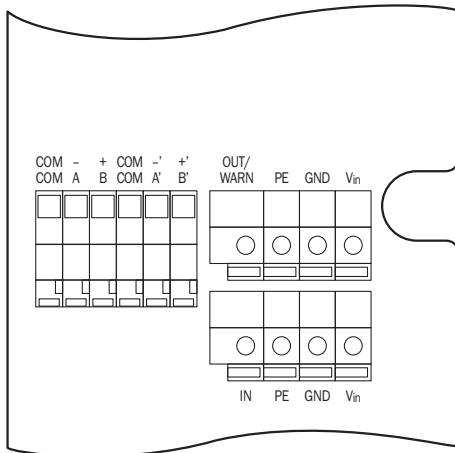

### Anschlussschema

#### Terminals, general

|                       |               |
|-----------------------|---------------|
| <b>V<sub>in</sub></b> | L+            |
| <b>GND</b>            | M             |
| <b>PE</b>             | Shield        |
| <b>OUT/WARN</b>       | Q             |
| <b>IN</b>             | Switch. input |

#### Terminals, PROFIBUS

|               |              |
|---------------|--------------|
| <b>A, -</b>   | A wire       |
| <b>B, +</b>   | B wire       |
| <b>COM</b>    | Pot. balance |
| <b>A', -'</b> | A wire       |
| <b>B', +'</b> | B wire       |



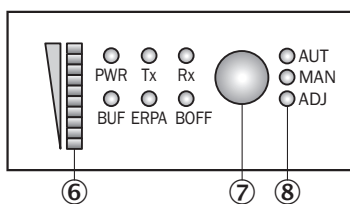



### Adjustments ISD300 RS-485/PROFIBUS, ISD300 RS-422/Interbus, ISD300 DH+/RIO, ISD300 DeviceNet/CANopen



- ⑥ Display for signal level
- ⑦ operating mode selector switch
- ⑧ LED operating indicator

Recommended accessories

Other models and accessories → [www.sick.com/ISD300](http://www.sick.com/ISD300)

|   | Brief description  | Type           | part no. |
|---|--|----------------|----------|
| connectors and cables   |  |                |          |
|    | <ul style="list-style-type: none"> <li><b>Description:</b> CANopen, shielded, DeviceNet™</li> <li><b>Connection type head A:</b> Female connector, M12, 5-pin, straight, A-coded</li> <li><b>Signal type:</b> CANopen, DeviceNet™</li> <li><b>Connection systems:</b> Screw-type terminals</li> <li><b>Permitted cross-section:</b> ≤ 0.75 mm²</li> </ul>  | DOS-1205-GA    | 6027534  |
|    | <ul style="list-style-type: none"> <li><b>Description:</b> CANopen, shielded, DeviceNet™</li> <li><b>Connection type head A:</b> Male connector, M12, 5-pin, straight, A-coded</li> <li><b>Signal type:</b> CANopen, DeviceNet™</li> <li><b>Connection systems:</b> Screw-type terminals</li> <li><b>Permitted cross-section:</b> ≤ 0.75 mm²</li> </ul>  | STE-1205-GA    | 6027533  |
|    | <ul style="list-style-type: none"> <li><b>Description:</b> PROFIBUS DP, shielded</li> <li><b>Connection type head A:</b> Female connector, M12, 5-pin, straight, B-coded</li> <li><b>Signal type:</b> PROFIBUS DP</li> <li><b>Connection systems:</b> Screw-type terminals</li> <li><b>Permitted cross-section:</b> ≤ 0.75 mm²</li> </ul>  | DOS-1205-GQ    | 6021353  |
|    | <ul style="list-style-type: none"> <li><b>Description:</b> PROFIBUS DP, shielded</li> <li><b>Connection type head A:</b> Male connector, M12, 5-pin, straight, B-coded</li> <li><b>Signal type:</b> PROFIBUS DP</li> <li><b>Connection systems:</b> Screw-type terminals</li> <li><b>Permitted cross-section:</b> ≤ 0.75 mm²</li> </ul>  | STE-1205-GQ    | 6021354  |
|    | <ul style="list-style-type: none"> <li><b>Connection type head A:</b> Male connector, M12, 5-pin, straight, B-coded</li> <li><b>Connection type head B:</b> Flying leads</li> <li><b>Signal type:</b> PROFIBUS DP</li> <li><b>Cable:</b> 5 m, 2-wire, PUR, halogen-free</li> <li><b>Description:</b> PROFIBUS DP, twisted pair, shielded</li> <li><b>Note:</b> Wire shield Al-Pt film, overall shield C-screen tin-plated</li> <li><b>Application:</b> Zones with oils and lubricants, Drag chain operation</li> </ul> | STL-1205-G05MQ | 6026005  |
|  | <ul style="list-style-type: none"> <li><b>Connection type head A:</b> Flying leads</li> <li><b>Connection type head B:</b> Flying leads</li> <li><b>Signal type:</b> PROFIBUS DP</li> <li><b>Items supplied:</b> By the meter</li> <li><b>Cable:</b> 2-wire, PUR</li> <li><b>Description:</b> PROFIBUS DP, shielded</li> </ul>   | LTG-2102-MW    | 6021355  |
|  | <ul style="list-style-type: none"> <li><b>Connection type head A:</b> Flying leads</li> <li><b>Connection type head B:</b> Flying leads</li> <li><b>Signal type:</b> CANopen, DeviceNet™</li> <li><b>Items supplied:</b> By the meter</li> <li><b>Cable:</b> 4-wire, twisted pair</li> <li><b>Description:</b> CANopen, shielded, DeviceNet™</li> <li><b>Note:</b> Wire shield Al-Pt film, overall shield C-screen tin-plated</li> </ul>   | LTG-2804-MW    | 6028328  |

## SICK AT A GLANCE

SICK is one of the leading manufacturers of intelligent sensors and sensor solutions for industrial applications. A unique range of products and services creates the perfect basis for controlling processes securely and efficiently, protecting individuals from accidents and preventing damage to the environment.

We have extensive experience in a wide range of industries and understand their processes and requirements. With intelligent sensors, we can deliver exactly what our customers need. In application centers in Europe, Asia and North America, system solutions are tested and optimized in accordance with customer specifications. All this makes us a reliable supplier and development partner.

Comprehensive services complete our offering: SICK LifeTime Services provide support throughout the machine life cycle and ensure safety and productivity.

For us, that is “Sensor Intelligence.”

## WORLDWIDE PRESENCE:

Contacts and other locations –[www.sick.com](http://www.sick.com)