



ISD300-1111

ISD300

OPTICAL DATA TRANSMISSION

SICK
Sensor Intelligence.



Illustration may differ



Ordering information

Type	part no.
ISD300-1111	6024761

Other models and accessories → www.sick.com/ISD300

Detailed technical data

Features

Product segment	Optical data transmission
Product	ISD300
Housing material	Metal
Enclosure rating	IP65
Power consumption	≤ 0.2 A
Ambient operating temperature	-5 °C ... +50 °C
Storage temperature	-30 °C ... +70 °C
Relative humidity	90 %, Non-condensing

Mechanics/electronics

Supply voltage V_s	DC 18 V ... 30 V
Transmission range	0.2 m 120 m
Connection type	Terminals
Current consumption	≤ 0.2 A
Frequency	F1 ¹⁾
Enclosure rating	IP65
Protection class	I

¹⁾ A pair of devices with numbers ending in 1 and 2 are required to create a data transfer section.

Performance

Transmission range	0.2 m ... 120 m
Light source	LED, infrared (880 nm)
Typ. light spot size (distance)	1.75 m (at 100 m)
Aperture angle	Ca. ± 0.5°

Interfaces

PROFIBUS DP	✓, RS-485
--------------------	-----------

¹⁾ 0 V ... 2 V: interference-free operation.

²⁾ $V_s - 2$ V: reduced system reserve.

	Data transmission rate	1.5 Mbit/s
Serial		✓
	Data transmission rate	1.5 Mbit/s
Digital input		0 V ... 2 V: sender deactivated
Digital output		
	Number	1 ^{1) 2)}
Signal delay		≤ 1.5 μs, + 1 Tbit

¹⁾ 0 V ... 2 V: interference-free operation.

²⁾ $V_S - 2 V$: reduced system reserve.

Ambient data

Electromagnetic compatibility (EMC)	EN 61000-6-2 EN 61000-6-4
Ambient temperature, operation	-5 °C ... +50 °C
Ambient temperature, storage	-30 °C ... +70 °C
Max. rel. humidity (not condensing)	90 %, Non-condensing

General notes

Note	2 devices are required to construct a data transmission path: ISD300-xxx1 (frequency 1) and ISD300-xxx2 (frequency 2). The two devices must be ordered separately.
-------------	--

Classifications

ECLASS 5.0	19039001
ECLASS 5.1.4	19039001
ECLASS 6.0	19179090
ECLASS 6.2	19179090
ECLASS 7.0	19179090
ECLASS 8.0	19179090
ECLASS 8.1	19179090
ECLASS 9.0	19179090
ETIM 5.0	EC000515
ETIM 6.0	EC000515
UNSPSC 16.0901	43201404

Certificates

EU declaration of conformity	✓
UK declaration of conformity	✓
ACMA declaration of conformity	✓
China RoHS	✓

Dimensional drawing: DSC-1608-1208

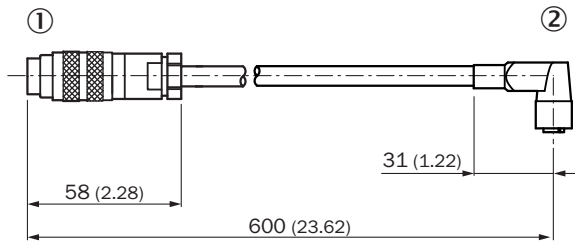

- Dimensions in mm (inch)
 ① Connector M16, 8-pin
 ② male connector M12, 8-pin

Dimensional drawing ISD300 RS-485/PROFIBUS, ISD300 RS-422/Interbus, ISD300 DH+/RIO, ISD300 DeviceNet/CANopen

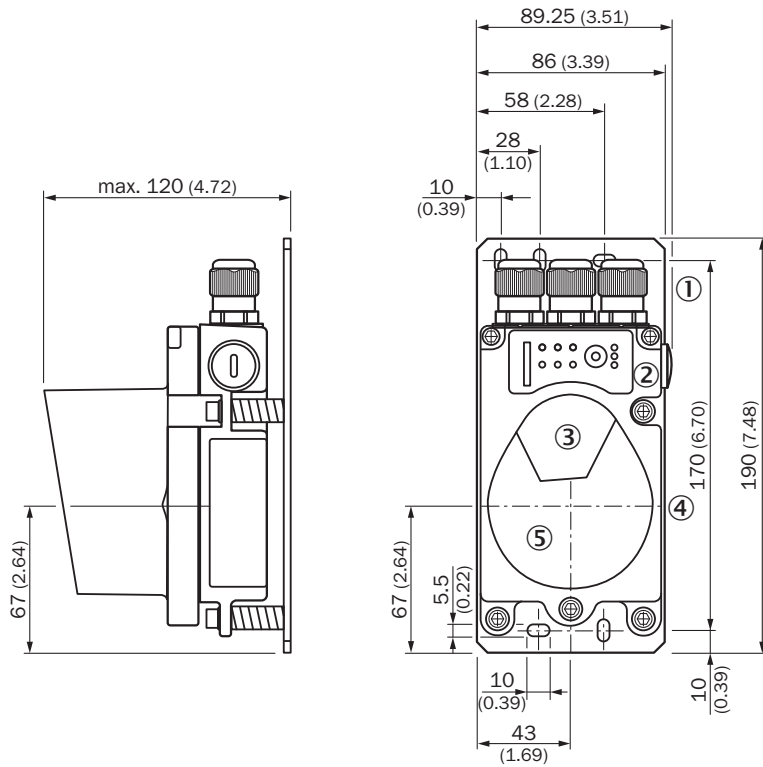

- Dimensions in mm (inch)
 ① M16 gland
 ② Control panel
 ③ Sender lens
 ④ Center of optical axis
 ⑤ Receiver lens

Connection type ISD300 RS-485/PROFIBUS

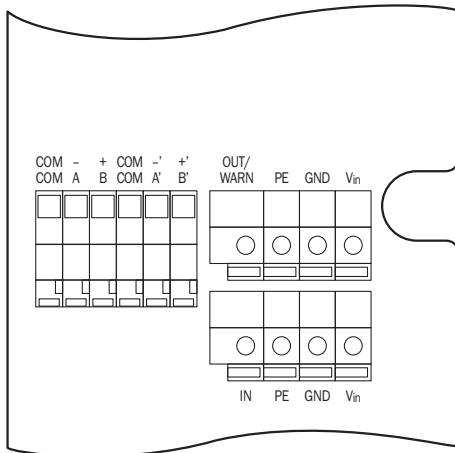

Anschlussschema

Terminals, general

V_{in}	L+
GND	M
PE	Shield
OUT/WARN	Q
IN	Switch. input

Terminals, PROFIBUS

A, -	A wire
B, +	B wire
COM	Pot. balance
A', -'	A wire
B', +'	B wire



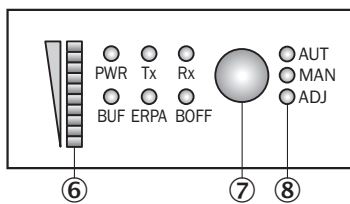



Adjustments ISD300 RS-485/PROFIBUS, ISD300 RS-422/Interbus, ISD300 DH+/RIO, ISD300 DeviceNet/CANopen



- ⑥ Display for signal level
- ⑦ operating mode selector switch
- ⑧ LED operating indicator

Recommended accessories

Other models and accessories → www.sick.com/ISD300

	Brief description	Type	part no.
connectors and cables			
	<ul style="list-style-type: none"> Description: CANopen, shielded, DeviceNet™ Connection type head A: Female connector, M12, 5-pin, straight, A-coded Signal type: CANopen, DeviceNet™ Connection systems: Screw-type terminals Permitted cross-section: ≤ 0.75 mm² 	DOS-1205-GA	6027534
	<ul style="list-style-type: none"> Description: CANopen, shielded, DeviceNet™ Connection type head A: Male connector, M12, 5-pin, straight, A-coded Signal type: CANopen, DeviceNet™ Connection systems: Screw-type terminals Permitted cross-section: ≤ 0.75 mm² 	STE-1205-GA	6027533
	<ul style="list-style-type: none"> Description: PROFIBUS DP, shielded Connection type head A: Female connector, M12, 5-pin, straight, B-coded Signal type: PROFIBUS DP Connection systems: Screw-type terminals Permitted cross-section: ≤ 0.75 mm² 	DOS-1205-GQ	6021353
	<ul style="list-style-type: none"> Description: PROFIBUS DP, shielded Connection type head A: Male connector, M12, 5-pin, straight, B-coded Signal type: PROFIBUS DP Connection systems: Screw-type terminals Permitted cross-section: ≤ 0.75 mm² 	STE-1205-GQ	6021354
	<ul style="list-style-type: none"> Connection type head A: Male connector, M12, 5-pin, straight, B-coded Connection type head B: Flying leads Signal type: PROFIBUS DP Cable: 5 m, 2-wire, PUR, halogen-free Description: PROFIBUS DP, twisted pair, shielded Note: Wire shield Al-Pt film, overall shield C-screen tin-plated Application: Zones with oils and lubricants, Drag chain operation 	STL-1205-G05MQ	6026005
	<ul style="list-style-type: none"> Connection type head A: Flying leads Connection type head B: Flying leads Signal type: PROFIBUS DP Items supplied: By the meter Cable: 2-wire, PUR Description: PROFIBUS DP, shielded 	LTG-2102-MW	6021355
	<ul style="list-style-type: none"> Connection type head A: Flying leads Connection type head B: Flying leads Signal type: CANopen, DeviceNet™ Items supplied: By the meter Cable: 4-wire, twisted pair Description: CANopen, shielded, DeviceNet™ Note: Wire shield Al-Pt film, overall shield C-screen tin-plated 	LTG-2804-MW	6028328

SICK AT A GLANCE

SICK is one of the leading manufacturers of intelligent sensors and sensor solutions for industrial applications. A unique range of products and services creates the perfect basis for controlling processes securely and efficiently, protecting individuals from accidents and preventing damage to the environment.

We have extensive experience in a wide range of industries and understand their processes and requirements. With intelligent sensors, we can deliver exactly what our customers need. In application centers in Europe, Asia and North America, system solutions are tested and optimized in accordance with customer specifications. All this makes us a reliable supplier and development partner.

Comprehensive services complete our offering: SICK LifeTime Services provide support throughout the machine life cycle and ensure safety and productivity.

For us, that is “Sensor Intelligence.”

WORLDWIDE PRESENCE:

Contacts and other locations –www.sick.com