



# VL18-3F3940

V18

PHOTOELECTRIC SENSORS

**SICK**  
Sensor Intelligence.



Illustration may differ



### Ordering information

| Type        | part no. |
|-------------|----------|
| VL18-3F3940 | 6013656  |

Other models and accessories → [www.sick.com/V18](http://www.sick.com/V18)

### Detailed technical data

#### Features

|  |                                       |
|--|---------------------------------------|
| <b>Functional principle</b>            | Photoelectric retro-reflective sensor |
| <b>Dimensions (W x H x D)</b>          | 18 mm x 18 mm x 75 mm                 |
| <b>Housing design (light emission)</b> | Cylindrical                           |
| <b>Housing length</b>                  | 75 mm                                 |
| <b>Thread diameter (housing)</b>       | M18 x 1                               |
| <b>Optical axis</b>                    | Radial                                |
| <b>Sensing range max.</b>              | 0.05 m ... 3.7 m <sup>1)</sup>        |
| <b>Sensing range</b>                   | 0.05 m ... 3 m <sup>1)</sup>          |
| <b>Focus</b>                           | Approx. 2.8°                          |
| <b>Type of light</b>                   | Visible red light                     |
| <b>Light source</b>                    | LED <sup>2)</sup>                     |
| <b>Light spot size (distance)</b>      | Ø 150 mm (3 m)                        |
| <b>Angle of dispersion</b>             | Approx. 2.8°                          |
| <b>Adjustment</b>                      | Potentiometer, 270° (Sensitivity)     |

<sup>1)</sup> Reflector C110A.

<sup>2)</sup> Average service life: 100,000 h at T<sub>J</sub> = +25 °C.

## Mechanics/electronics

|   |  |
|---|--|
| <b>Supply voltage <math>U_B</math></b>      | 10 V DC ... 30 V DC <sup>1)</sup>  |
| <b>Ripple</b>                               | $\pm 10\%$ <sup>2)</sup>   |
| <b>Current consumption</b>                  | 30 mA <sup>3)</sup>  |
| <b>Switching output</b>                     | PNP  |
| <b>Switching mode</b>                       | Light switching  |
| <b>Output current <math>I_{max.}</math></b> | $\leq 100$ mA  |
| <b>Response time</b>                        | $\leq 2$ ms <sup>4)</sup>  |
| <b>Switching frequency</b>                  | 250 Hz <sup>5)</sup>   |
| <b>Connection type</b>                      | Male connector M12, 4-pin  |
| <b>Circuit protection</b>                   | A <sup>6)</sup><br>B <sup>7)</sup><br>C <sup>8)</sup><br>D <sup>9)</sup> |
| <b>Protection class</b>                     | III  |
| <b>Weight</b>                               | 100 g  |
| <b>Polarizing filter</b>                    | ✓  |
| <b>Housing material</b>                     | Plastic, PBT/PC  |
| <b>Optics material</b>                      | Plastic, PMMA  |
| <b>Enclosure rating</b>                     | IP67   |
| <b>Ambient operating temperature</b>        | -25 °C ... +70 °C  |
| <b>UL File No.</b>                          | NMFT2.E175606  |

<sup>1)</sup> Limit values.

<sup>2)</sup> May not fall below or exceed  $U_y$  tolerances.

<sup>3)</sup> Without load.

<sup>4)</sup> Signal transit time with resistive load.

<sup>5)</sup> With light/dark ratio 1:1.

<sup>6)</sup> A =  $V_S$  connections reverse-polarity protected.

<sup>7)</sup> B = inputs and output reverse-polarity protected.

<sup>8)</sup> C = interference suppression.

<sup>9)</sup> D = outputs overcurrent and short-circuit protected.

## Certificates

|   |   |
|---|---|
| <b>EU declaration of conformity</b>       | ✓ |
| <b>UK declaration of conformity</b>       | ✓ |
| <b>ACMA declaration of conformity</b>     | ✓ |
| <b>Moroccan declaration of conformity</b> | ✓ |
| <b>China RoHS</b>                         | ✓ |
| <b>cRUus certificate</b>                  | ✓ |

## Classifications

|                     |          |
|---------------------|----------|
| <b>ECLASS 5.0</b>   | 27270902 |
| <b>ECLASS 5.1.4</b> | 27270902 |
| <b>ECLASS 6.0</b>   | 27270902 |
| <b>ECLASS 6.2</b>   | 27270902 |

|                       |          |
|-----------------------|----------|
| <b>ECLASS 7.0</b>     | 27270902 |
| <b>ECLASS 8.0</b>     | 27270902 |
| <b>ECLASS 8.1</b>     | 27270902 |
| <b>ECLASS 9.0</b>     | 27270902 |
| <b>ECLASS 10.0</b>    | 27270902 |
| <b>ECLASS 11.0</b>    | 27270902 |
| <b>ECLASS 12.0</b>    | 27270902 |
| <b>ETIM 5.0</b>       | EC002717 |
| <b>ETIM 6.0</b>       | EC002717 |
| <b>ETIM 7.0</b>       | EC002717 |
| <b>ETIM 8.0</b>       | EC002717 |
| <b>UNSPSC 16.0901</b> | 39121528 |

### Adjustments

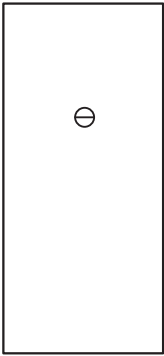

### Connection type

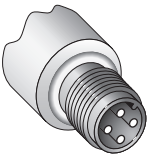

### Characteristic curve

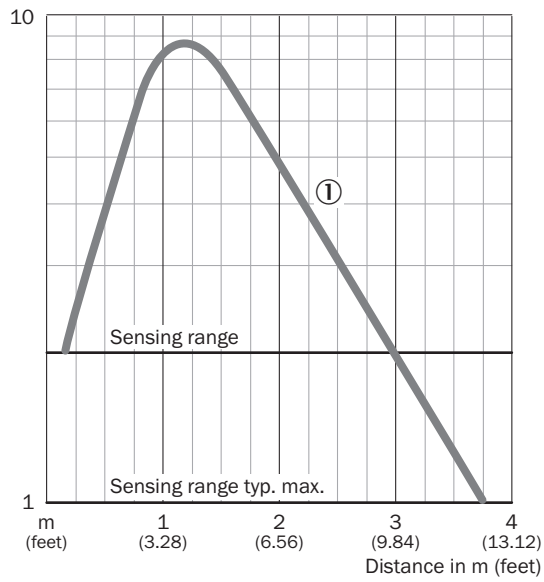

### Sensing range diagram

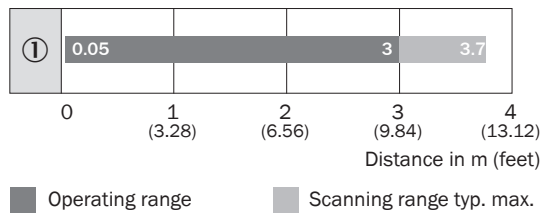

① Reflector type C110

Dimensional drawing

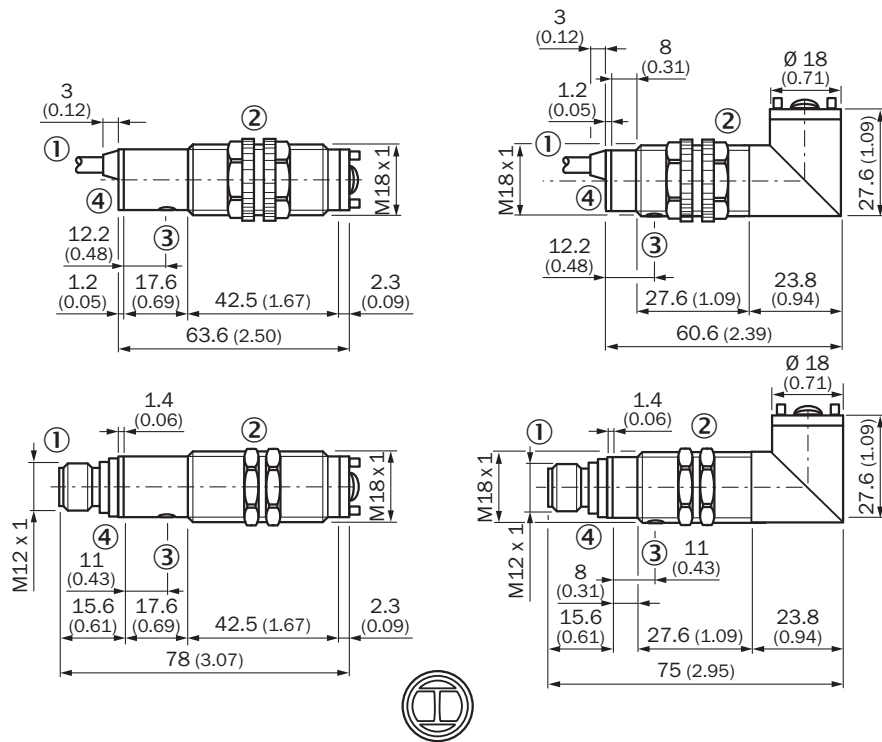







Dimensions in mm (inch)

- ① Connecting cable or connector
- ② Fastening nut, 22 mm hex, made of plastic for equipment with plastic housing
- ② Fastening nut, 24 mm hex, made of metal for equipment with metal housing
- ③ sensitivity control
- ④ Signal strength indicator, LED, yellow

## Recommended accessories

Other models and accessories → [www.sick.com/V18](http://www.sick.com/V18)

|   | Brief description  | Type               | part no. |
|---|--|--------------------|----------|
| <b>Mounting systems</b>   |  |                    |          |
|    | <ul style="list-style-type: none"> <li><b>Description:</b> Mounting bracket for M18 sensors</li> <li><b>Material:</b> Steel</li> <li><b>Details:</b> Steel, zinc coated</li> <li><b>Items supplied:</b> Without mounting hardware</li> <li><b>Suitable for:</b> GR18, V180-2, V18, W15, Z1, Z2</li> </ul>  | BEF-WN-M18         | 5308446  |
|    | <ul style="list-style-type: none"> <li><b>Description:</b> Universal mounting bracket for reflectors</li> <li><b>Dimensions (W x H x L):</b> 85 mm x 90 mm x 35 mm</li> <li><b>Material:</b> Steel</li> <li><b>Details:</b> Steel, zinc coated</li> <li><b>Suitable for:</b> C110A, P250, PL20, PL30A, PL40A, PL80A</li> </ul>   | BEF-WN-REFX        | 2064574  |
|    | <ul style="list-style-type: none"> <li><b>Description:</b> Plate N11N for universal clamp bracket</li> <li><b>Material:</b> Stainless steel</li> <li><b>Details:</b> Stainless steel 1.4571 (sheet), Stainless steel 1.4408 (clamp)</li> <li><b>Items supplied:</b> Universal clamp (5322627), mounting hardware</li> <li><b>Usable for:</b> DeltaPac, Glare, WTD20E</li> </ul>  | BEF-KHS-N11N       | 2071081  |
| <b>connectors and cables</b>  |  |                    |          |
|    | <ul style="list-style-type: none"> <li><b>Description:</b> Sensor/actuator cable, unshielded</li> <li><b>Connection type head A:</b> Female connector, M12, 4-pin, straight, A-coded</li> <li><b>Connection type head B:</b> Flying leads</li> <li><b>Signal type:</b> Sensor/actuator cable</li> <li><b>Cable:</b> 5 m, 4-wire, PVC</li> <li><b>Application:</b> Uncontaminated zones, Zones with chemicals</li> </ul>  | YF2A14-050VB3XLEAX | 2096235  |
|   | <ul style="list-style-type: none"> <li><b>Description:</b> Unshielded</li> <li><b>Connection type head A:</b> Male connector, M12, 4-pin, straight, A-coded</li> <li><b>Connection systems:</b> Screw-type terminals</li> <li><b>Permitted cross-section:</b> ≤ 0.75 mm<sup>2</sup></li> </ul>   | STE-1204-G         | 6009932  |
|  | <ul style="list-style-type: none"> <li><b>Description:</b> Sensor/actuator cable, unshielded</li> <li><b>Connection type head A:</b> Female connector, M12, 4-pin, straight, A-coded</li> <li><b>Connection type head B:</b> Flying leads</li> <li><b>Signal type:</b> Sensor/actuator cable</li> <li><b>Cable:</b> 5 m, 4-wire, PUR, halogen-free</li> <li><b>Application:</b> Drag chain operation, Zones with oils and lubricants, Robot, Drag chain operation</li> </ul> | YF2A14-050UB3XLEAX | 2095608  |
| <b>reflectors and optics</b>  |  |                    |          |
|  | <ul style="list-style-type: none"> <li><b>Description:</b> Rectangular, screw connection</li> <li><b>Dimensions:</b> 51 mm 61 mm</li> <li><b>Ambient operating temperature:</b> -30 °C ... +65 °C</li> </ul>   | P250               | 5304812  |

## SICK AT A GLANCE

SICK is one of the leading manufacturers of intelligent sensors and sensor solutions for industrial applications. A unique range of products and services creates the perfect basis for controlling processes securely and efficiently, protecting individuals from accidents and preventing damage to the environment.

We have extensive experience in a wide range of industries and understand their processes and requirements. With intelligent sensors, we can deliver exactly what our customers need. In application centers in Europe, Asia and North America, system solutions are tested and optimized in accordance with customer specifications. All this makes us a reliable supplier and development partner.

Comprehensive services complete our offering: SICK LifeTime Services provide support throughout the machine life cycle and ensure safety and productivity.

For us, that is “Sensor Intelligence.”

## WORLDWIDE PRESENCE:

Contacts and other locations –[www.sick.com](http://www.sick.com)