

# BEF-MR10200AP

Measuring wheels

MEASURING WHEELS AND MEASURING WHEEL MECHANICS

**SICK**  
Sensor Intelligence.



### Ordering information

Type	part no.
BEF-MR10200AP	4084738

Other models and accessories → [www.sick.com/Measuring\\_wheels](http://www.sick.com/Measuring_wheels)

### Detailed technical data

#### Features

<b>Product segment</b>	Measuring wheels and measuring wheel mechanics
<b>Product</b>	Measuring wheels
<b>Description</b>	Aluminum measuring wheel with smooth polyurethane surface for 10 mm solid shaft, circumference 200 mm
<b>Circumference</b>	200 mm
<b>Inner diameter</b>	10 mm
<b>Characteristics of the measuring wheel surface</b>	Smooth polyurethan
<b>Product version</b>	Measuring wheel
<b>Bore diameter</b>	10 mm
<b>Operating temperature</b>	-30 °C ... +80 °C

#### Classifications

<b>ECLASS 5.0</b>	21160104
<b>ECLASS 5.1.4</b>	21160104
<b>ECLASS 6.0</b>	21160104
<b>ECLASS 6.2</b>	21160104
<b>ECLASS 7.0</b>	21160104
<b>ECLASS 8.0</b>	21160104
<b>ECLASS 8.1</b>	21160104
<b>ECLASS 9.0</b>	21160104
<b>ECLASS 10.0</b>	21160104
<b>ECLASS 11.0</b>	21160104
<b>ECLASS 12.0</b>	21160104
<b>ETIM 5.0</b>	EC002179
<b>ETIM 6.0</b>	EC002179
<b>ETIM 7.0</b>	EC002179
<b>ETIM 8.0</b>	EC002179
<b>UNSPSC 16.0901</b>	25191839

Dimensional drawing

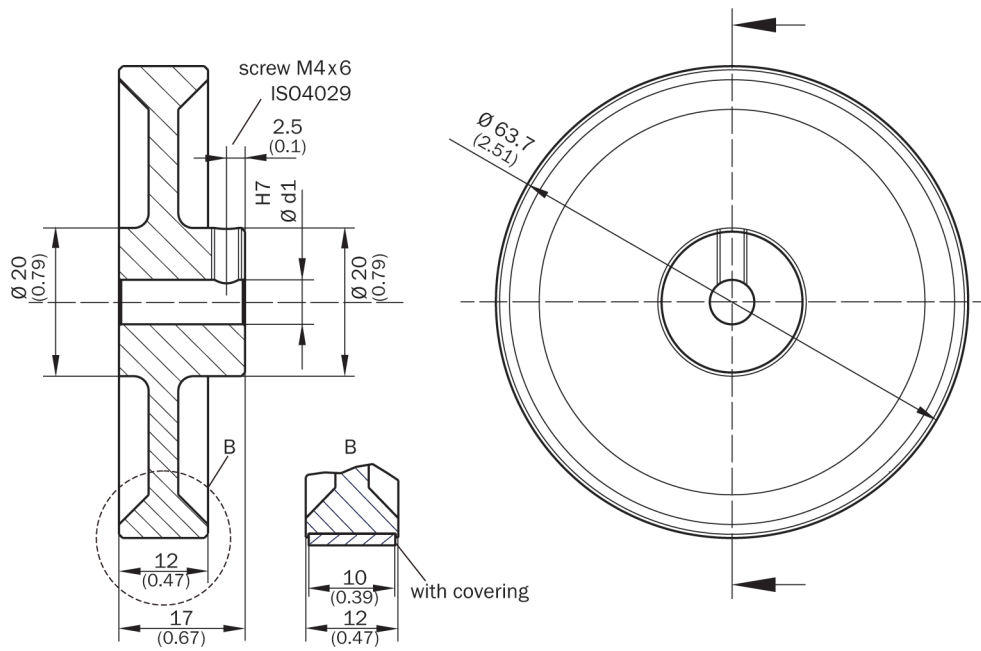

Dimensions in mm (inch)

## SICK AT A GLANCE

SICK is one of the leading manufacturers of intelligent sensors and sensor solutions for industrial applications. A unique range of products and services creates the perfect basis for controlling processes securely and efficiently, protecting individuals from accidents and preventing damage to the environment.

We have extensive experience in a wide range of industries and understand their processes and requirements. With intelligent sensors, we can deliver exactly what our customers need. In application centers in Europe, Asia and North America, system solutions are tested and optimized in accordance with customer specifications. All this makes us a reliable supplier and development partner.

Comprehensive services complete our offering: SICK LifeTime Services provide support throughout the machine life cycle and ensure safety and productivity.

For us, that is “Sensor Intelligence.”

## WORLDWIDE PRESENCE:

Contacts and other locations –[www.sick.com](http://www.sick.com)