



Y8A48A2-LXXXUFA050

Passive distribution boxes

CONNECTORS AND CABLES

SICK
Sensor Intelligence.



Ordering information

Type	part no.
Y8A48A2-LXXXUFA050	2115730

Other models and accessories → www.sick.com/Passive_distribution_boxes



Detailed technical data

Technical specifications

Switching output	PNP
Shielding	Unshielded
Number of slots	8
Slot connection type	M8, 4-pin, A-coded, female connector
Root port connection type	Flying leads
Connecting cable	5 m, 18-wire, PUR, halogen-free
Cable diameter	10.4 mm
Cable color	Gray
Conductor cross section	2 x 0.75 mm ² + 16 x 0.34 mm ²
Traversing speed	2 m/s
Travelling distance	5 m
Acceleration	≤ 5 m/s ²
Bending radius	
Flexible use	> 10 x cable diameter
Stationary position	> 10 x cable diameter
Drag chain operation	> 10 x cable diameter
Bending cycles	≤ 5,000,000
Tightening torque	
Slots	0.4 Nm
Display LED	
Slots	2 x per socket
Root port	1x per distributor
Reference voltage	≤ 24 V DC
Current loading	10 A
Overvoltage category	III
Operating temperature	
Flexible use	-5 °C ... +80 °C
Stationary position	-40 °C ... +80 °C

	Drag chain operation	-5 °C ... +60 °C
	Distributor box	-20 °C ... +72 °C
Enclosure rating		IP65/ IP67
UL File No.		E238799
Authorizations		UL CE
Items supplied		10 x labeling plates

Certificates

EU declaration of conformity	✓
China RoHS	✓
cULus certificate	✓

Classifications

ECLASS 5.0	27279201
ECLASS 5.1.4	27279201
ECLASS 6.0	27279201
ECLASS 6.2	27279201
ECLASS 7.0	27279201
ECLASS 8.0	27279201
ECLASS 8.1	27279201
ECLASS 9.0	27440108
ECLASS 10.0	27440108
ECLASS 11.0	27440108
ECLASS 12.0	27440108
ETIM 5.0	EC002585
ETIM 6.0	EC002585
ETIM 7.0	EC002585
ETIM 8.0	EC002585
UNSPSC 16.0901	31163032

Dimensional drawing

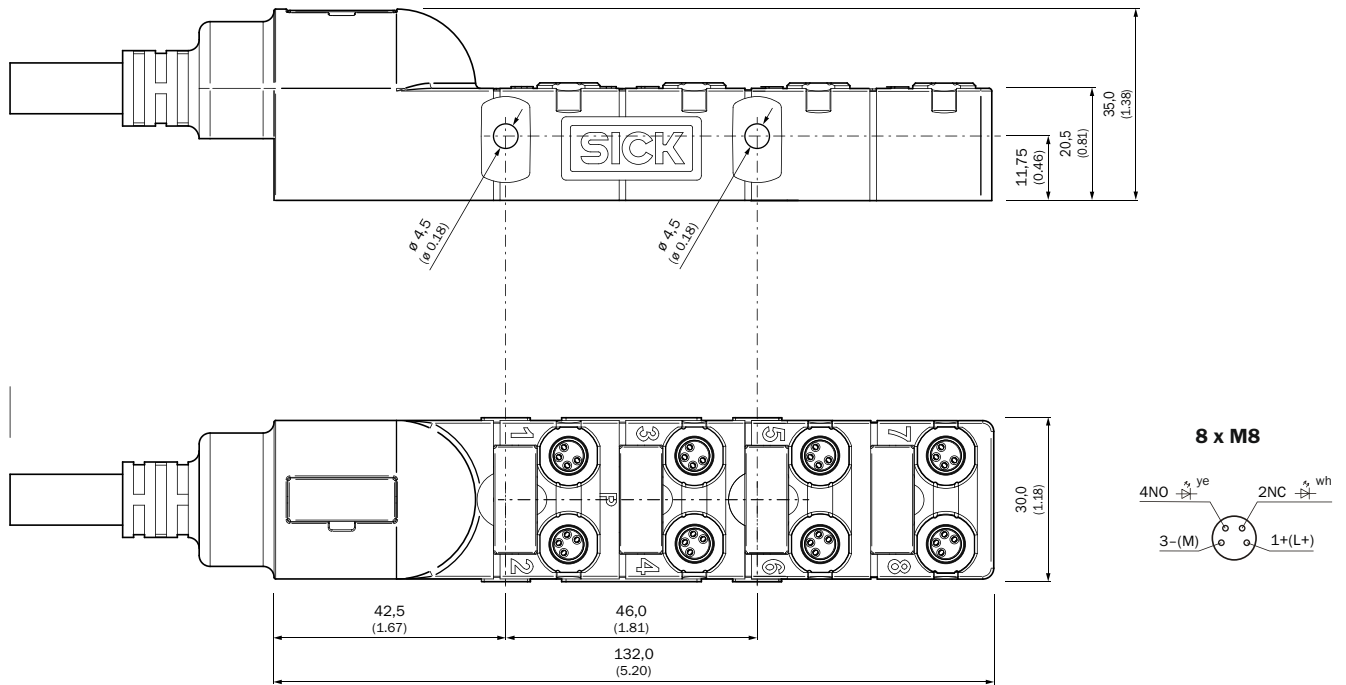





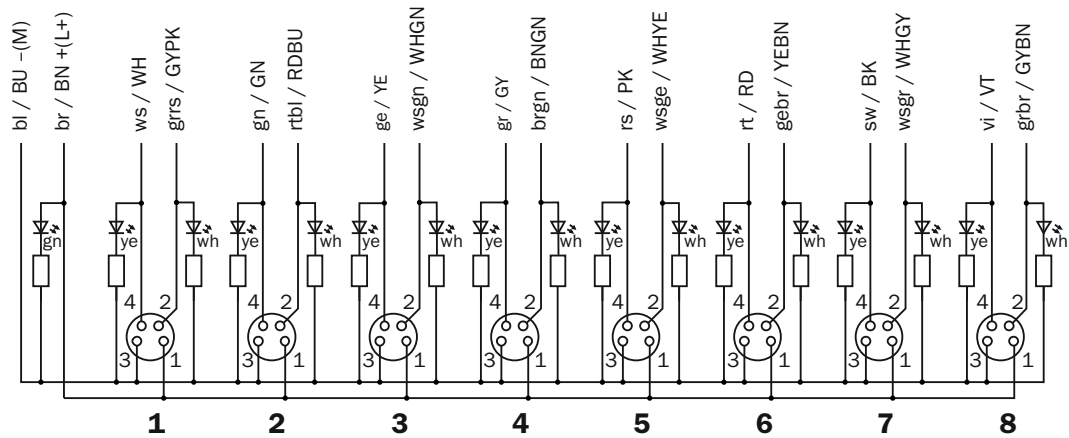

Dimensions in mm (inch)

Connection diagram Cd-477



Recommended accessories

Other models and accessories → www.sick.com/Passive_distribution_boxes

	Brief description	Type	part no.
device protection and care			
	<ul style="list-style-type: none"> Description: Protective cap for M8 socket or unused ports 	DOS-08SK	5340762
connectors and cables			
	<ul style="list-style-type: none"> Description: Sensor/actuator cable, unshielded Connection type head A: Female connector, M8, 4-pin, straight, A-coded Connection type head B: Male connector, M8, 4-pin, straight, A-coded Signal type: Sensor/actuator cable Cable: 5 m, 4-wire, PUR, halogen-free Application: Drag chain operation, Zones with oils and lubricants, Robot, Drag chain operation 	YF8U14-050UA3M8U14	2096348
	<ul style="list-style-type: none"> Description: Unshielded Connection type head A: Male connector, M8, 4-pin, A-coded Connection type head B: Female connector, M8, 3-pin, A-coded Connection type head C: Female connector, M8, 3-pin, A-coded Cable: 0.3 m, 3-wire, PUR, halogen-free 	YM8U14-C30UA1FY8A3	2122298
	<ul style="list-style-type: none"> Description: Sensor/actuator cable, unshielded Connection type head A: Female connector, M8, 4-pin, straight, A-coded Connection type head B: Male connector, M8, 4-pin, straight, A-coded Signal type: Sensor/actuator cable Cable: 1 m, 4-wire, PUR, halogen-free Application: Drag chain operation, Zones with oils and lubricants, Robot, Drag chain operation 	YF8U14-010UA3M8U14	2143896
	<ul style="list-style-type: none"> Description: Sensor/actuator cable, unshielded Connection type head A: Female connector, M8, 4-pin, straight, A-coded Connection type head B: Male connector, M8, 4-pin, straight, A-coded Signal type: Sensor/actuator cable Cable: 10 m, 4-wire, PUR, halogen-free Application: Drag chain operation, Zones with oils and lubricants, Robot, Drag chain operation 	YF8U14-100UA3M8U14	2145840
	<ul style="list-style-type: none"> Description: Sensor/actuator cable, unshielded Connection type head A: Female connector, M8, 4-pin, straight, A-coded Connection type head B: Male connector, M8, 4-pin, straight, A-coded Signal type: Sensor/actuator cable Cable: 0.3 m, 4-wire, PUR, halogen-free Application: Drag chain operation, Zones with oils and lubricants, Robot, Drag chain operation 	YF8U14-C30UA3M8U14	2126078

SICK AT A GLANCE

SICK is one of the leading manufacturers of intelligent sensors and sensor solutions for industrial applications. A unique range of products and services creates the perfect basis for controlling processes securely and efficiently, protecting individuals from accidents and preventing damage to the environment.

We have extensive experience in a wide range of industries and understand their processes and requirements. With intelligent sensors, we can deliver exactly what our customers need. In application centers in Europe, Asia and North America, system solutions are tested and optimized in accordance with customer specifications. All this makes us a reliable supplier and development partner.

Comprehensive services complete our offering: SICK LifeTime Services provide support throughout the machine life cycle and ensure safety and productivity.

For us, that is “Sensor Intelligence.”

WORLDWIDE PRESENCE:

Contacts and other locations –www.sick.com