



BEF-KH-M04

Brackets

MOUNTING SYSTEMS

SICK
Sensor Intelligence.



Ordering information

Type	part no.
BEF-KH-M04	2101065

Other models and accessories → www.sick.com/Brackets

Detailed technical data

Features

Accessory group	Mounting systems
Accessory family	Brackets
Description	Terminal block for M8 cylindrical sensors without fixed stop
Material	Plastic (PA6)
Items supplied	Without mounting hardware
Tightening torque	1.1 Nm ¹⁾
Specialty	Without fixed stop
Tightening torque sensor	0.4 Nm ... 0.6 Nm ²⁾
Usable for	Round sensors with 4 mm housing diameter without fixed stop
Mounting system type	Brackets

¹⁾ Recommended tightening torque for bracket.

²⁾ Recommended tightening torque for sensor, for more information see sensor datasheet.

Classifications

ECLASS 5.0	27279202
ECLASS 5.1.4	27279202
ECLASS 6.0	27279202
ECLASS 6.2	27279202
ECLASS 7.0	27279202
ECLASS 8.0	27279202
ECLASS 8.1	27279202
ECLASS 9.0	27273701
ECLASS 10.0	27273701
ECLASS 11.0	27273701
ECLASS 12.0	27273701
ETIM 5.0	EC002024
ETIM 6.0	EC002024
ETIM 7.0	EC002024
ETIM 8.0	EC002024
UNSPSC 16.0901	32131023

Dimensional drawing

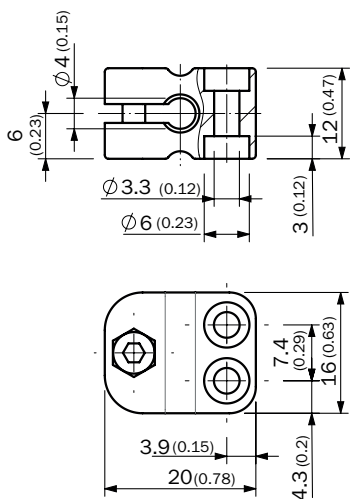

Dimensions in mm (inch)

Instruction for installation

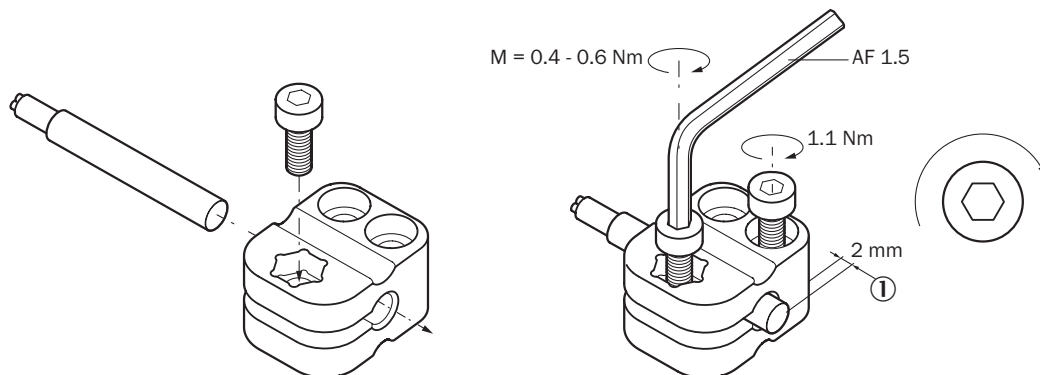

① Optimal installation position depends on the sensor model. Please check the sensor data sheet.

SICK AT A GLANCE

SICK is one of the leading manufacturers of intelligent sensors and sensor solutions for industrial applications. A unique range of products and services creates the perfect basis for controlling processes securely and efficiently, protecting individuals from accidents and preventing damage to the environment.

We have extensive experience in a wide range of industries and understand their processes and requirements. With intelligent sensors, we can deliver exactly what our customers need. In application centers in Europe, Asia and North America, system solutions are tested and optimized in accordance with customer specifications. All this makes us a reliable supplier and development partner.

Comprehensive services complete our offering: SICK LifeTime Services provide support throughout the machine life cycle and ensure safety and productivity.

For us, that is “Sensor Intelligence.”

WORLDWIDE PRESENCE:

Contacts and other locations –www.sick.com