



Connection cable

Other connectors and cables

CONNECTORS AND CABLES

SICK
Sensor Intelligence.



Ordering information

Type	part no.
Connection cable	2094435

Other models and accessories → www.sick.com/Other_connectors_and_cables



Detailed technical data

Technical specifications

Connection type head A	Male connector, Micro D-Sub, 15-pin, angled
Connection type head B	Female connector, M12, 12-pin, straight, A-coded
Cable	5 m
Shielding	Shielded
Note	For connecting the FX3-MOC motion control modules to an encoder

Certificates

EU declaration of conformity	✓
UK declaration of conformity	✓

Classifications

ECLASS 5.0	19030312
ECLASS 5.1.4	19030312
ECLASS 6.0	27060304
ECLASS 6.2	27060304
ECLASS 7.0	27060304
ECLASS 8.0	27060304
ECLASS 8.1	27060304
ECLASS 9.0	27060304
ECLASS 10.0	27060304
ECLASS 11.0	27060304
ECLASS 12.0	27060304
ETIM 5.0	EC000830
ETIM 6.0	EC000830
ETIM 7.0	EC003249
ETIM 8.0	EC003249
UNSPSC 16.0901	26121604

Dimensional drawing

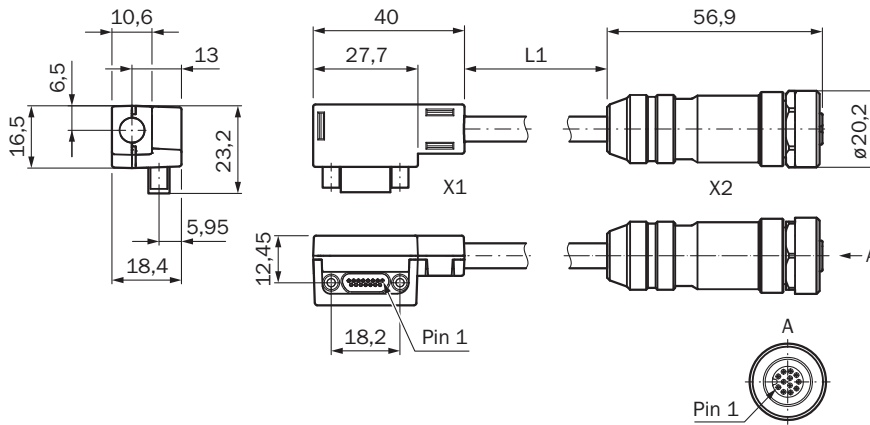

Dimensions in mm (inch)

PIN assignment

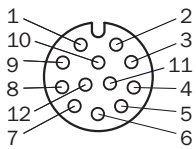

M12 female connector, 12-pin, A-coded		Male connector, Micro D-Sub, 15-pin	
SSI + Sin/Cos encoder, e.g., AFS/AFM60S Pro		FX3-MOC	
Pin	Designation	Pin	Designation
1	-	-	-
2	Data+	1	ENC1_A+
3	Data-	9	ENC1_A-
4	Clock-	11	ENC1_C-
5	24 V supply voltage	4	ENC1_24V
6	Cos+	8	ENC2_A+
7	Cos-	15	ENC2_A-
8	Sin+	7	ENC2_B+
9	Sin-	14	ENC2_B-
10	-	-	-
11	Clock+	3	ENC1_C+
12	GND supply voltage	12	ENC_OV

PIN assignment

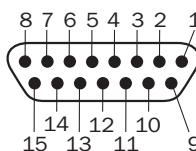

M12 female connector, 12-pin, A-coded		Male connector, Micro D-Sub, 15-pin	
SSI + Sin/Cos encoder, e.g., AFS/AFM60S Pro		FX3-MOC	
Pin	Designation	Pin	Designation
1	-	-	-
2	Data+	1	ENC1_A+
3	Data-	9	ENC1_A-
4	Clock-	11	ENC1_C-
5	24 V supply voltage	4	ENC1_24V
6	Cos+	8	ENC2_A+
7	Cos-	15	ENC2_A-
8	Sin+	7	ENC2_B+
9	Sin-	14	ENC2_B-
10	-	-	-
11	Clock+	3	ENC1_C+
12	GND supply voltage	12	ENC_0V

SICK AT A GLANCE

SICK is one of the leading manufacturers of intelligent sensors and sensor solutions for industrial applications. A unique range of products and services creates the perfect basis for controlling processes securely and efficiently, protecting individuals from accidents and preventing damage to the environment.

We have extensive experience in a wide range of industries and understand their processes and requirements. With intelligent sensors, we can deliver exactly what our customers need. In application centers in Europe, Asia and North America, system solutions are tested and optimized in accordance with customer specifications. All this makes us a reliable supplier and development partner.

Comprehensive services complete our offering: SICK LifeTime Services provide support throughout the machine life cycle and ensure safety and productivity.

For us, that is “Sensor Intelligence.”

WORLDWIDE PRESENCE:

Contacts and other locations –www.sick.com