



## Connection cable

Other connectors and cables

CONNECTORS AND CABLES

**SICK**  
Sensor Intelligence.



### Ordering information

Type	part no.
Connection cable	2094372

Other models and accessories → [www.sick.com/Other\\_connectors\\_and\\_cables](http://www.sick.com/Other_connectors_and_cables)



### Detailed technical data

#### Technical specifications

<b>Connection type head A</b>	Male connector, Micro D-Sub, 15-pin, angled
<b>Connection type head B</b>	Female connector, M12, 12-pin, straight, A-coded
<b>Cable</b>	1 m
<b>Shielding</b>	Shielded
<b>Note</b>	For connecting the FX3-MOC motion control modules to an encoder

#### Certificates

<b>EU declaration of conformity</b>	✓
<b>UK declaration of conformity</b>	✓

#### Classifications

<b>ECLASS 5.0</b>	19030312
<b>ECLASS 5.1.4</b>	19030312
<b>ECLASS 6.0</b>	27060304
<b>ECLASS 6.2</b>	27060304
<b>ECLASS 7.0</b>	27060304
<b>ECLASS 8.0</b>	27060304
<b>ECLASS 8.1</b>	27060304
<b>ECLASS 9.0</b>	27060304
<b>ECLASS 10.0</b>	27060304
<b>ECLASS 11.0</b>	27060304
<b>ECLASS 12.0</b>	27060304
<b>ETIM 5.0</b>	EC000830
<b>ETIM 6.0</b>	EC000830
<b>ETIM 7.0</b>	EC003249
<b>ETIM 8.0</b>	EC003249
<b>UNSPSC 16.0901</b>	26121604

### Dimensional drawing

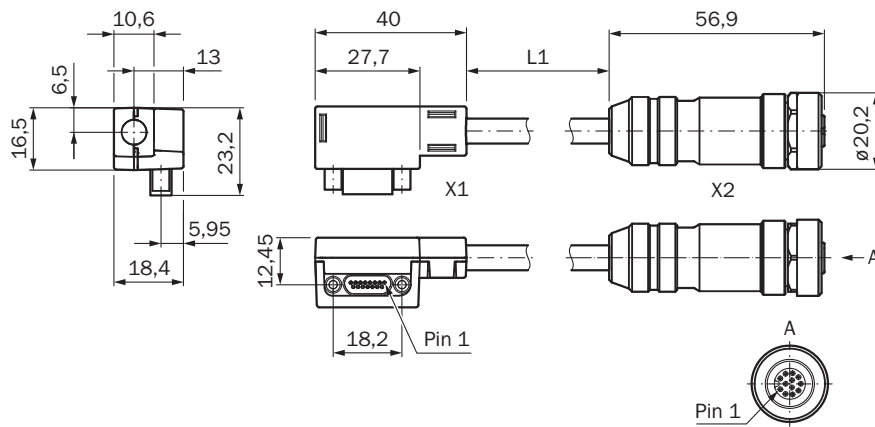

Dimensions in mm (inch)

### PIN assignment

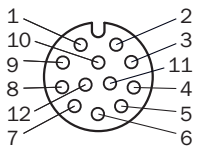

M12 female connector, 12-pin, A-coded		Male connector, Micro D-Sub, 15-pin	
SSI + Sin/Cos encoder, e.g., AFS/AFM60S Pro		FX3-MOC	
Pin	Designation	Pin	Designation
1	-	-	-
2	Data+	1	ENC1_A+
3	Data-	9	ENC1_A-
4	Clock-	11	ENC1_C-
5	24 V supply voltage	4	ENC1_24V
6	Cos+	8	ENC2_A+
7	Cos-	15	ENC2_A-
8	Sin+	7	ENC2_B+
9	Sin-	14	ENC2_B-
10	-	-	-
11	Clock+	3	ENC1_C+
12	GND supply voltage	12	ENC_OV

### PIN assignment

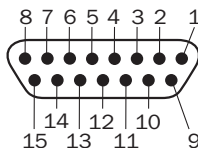

M12 female connector, 12-pin, A-coded		Male connector, Micro D-Sub, 15-pin	
SSI + Sin/Cos encoder, e.g., AFS/AFM60S Pro		FX3-MOC	
Pin	Designation	Pin	Designation
1	-	-	-
2	Data+	1	ENC1_A+
3	Data-	9	ENC1_A-
4	Clock-	11	ENC1_C-
5	24 V supply voltage	4	ENC1_24V
6	Cos+	8	ENC2_A+
7	Cos-	15	ENC2_A-
8	Sin+	7	ENC2_B+
9	Sin-	14	ENC2_B-
10	-	-	-
11	Clock+	3	ENC1_C+
12	GND supply voltage	12	ENC_0V

## SICK AT A GLANCE

SICK is one of the leading manufacturers of intelligent sensors and sensor solutions for industrial applications. A unique range of products and services creates the perfect basis for controlling processes securely and efficiently, protecting individuals from accidents and preventing damage to the environment.

We have extensive experience in a wide range of industries and understand their processes and requirements. With intelligent sensors, we can deliver exactly what our customers need. In application centers in Europe, Asia and North America, system solutions are tested and optimized in accordance with customer specifications. All this makes us a reliable supplier and development partner.

Comprehensive services complete our offering: SICK LifeTime Services provide support throughout the machine life cycle and ensure safety and productivity.

For us, that is “Sensor Intelligence.”

## WORLDWIDE PRESENCE:

Contacts and other locations –[www.sick.com](http://www.sick.com)