



## SP2-2300

System plugs deTec and deTem

SYSTEM PLUGS AND EXTENSION MODULES

**SICK**  
Sensor Intelligence.



### Ordering information

Type	part no.
SP2-2300	2093100

Other models and accessories → [www.sick.com/System\\_plugs\\_deTec\\_and\\_deTem](http://www.sick.com/System_plugs_deTec_and_deTem)



### Detailed technical data

#### Features

<b>Compatible devices</b>	deTec4, deTem4, deTem4 A/P
<b>Function range</b>	SP2
<b>System connection</b>	Male connector M12, 8-pin
<b>Extension connection</b>	Female connector M12, 5-pin
<b>IO-Link possible on the extension connection</b>	✓
<b>Configuration method</b>	DIP switch
<b>Items supplied</b>	System plug

#### Functions

<b>Protective operation</b>	✓
<b>Automatic calibration of the protective field width</b>	✓
<b>Restart interlock</b>	✓
<b>External device monitoring (EDM)</b>	✓
<b>Application diagnostic output (ADO)</b>	✓
<b>Cascading</b>	✓
<b>Smart presence detection</b>	✓
<b>Reduced resolution</b>	✓
<b>Dynamic protective field width during operation</b>	✓
<b>Sender with reduced scanning range</b>	✓
<b>Differentiation between person and material</b>	
2-signal muting	✓
Smart Box Detection	✓

#### Interfaces

<b>PIN assignment</b>	See table in "Pin assignment" graphic
<b>System connection</b>	Male connector M12, 8-pin
Length of cable	200 mm
Cable diameter	5 mm
<b>Extension connection</b>	Female connector M12, 5-pin

Length of cable	150 mm
Cable diameter	5 mm

### Electronics

<b>Protection class</b>	III (IEC 61140)
<b>Supply voltage <math>V_s</math></b>	24 V DC (19.2 V ... 28.8 V)
<b>Ripple</b>	≤ 10 %

### Ambient data

<b>Ambient operating temperature</b>	-30 °C ... +55 °C
<b>Storage temperature</b>	-30 °C ... +70 °C
<b>Air humidity</b>	15 % ... 95 %, Non-condensing
<b>Vibration resistance</b>	5 g, 10 Hz ... 55 Hz (IEC 60068-2-6)
<b>Shock resistance</b>	10 g, 16 ms (IEC 60068-2-27)

### Certificates

<b>EU declaration of conformity</b>	✓
-------------------------------------	---

### Classifications

<b>ECLASS 5.0</b>	27272790
<b>ECLASS 5.1.4</b>	27272790
<b>ECLASS 6.0</b>	27272790
<b>ECLASS 6.2</b>	27272790
<b>ECLASS 7.0</b>	27272790
<b>ECLASS 8.0</b>	27272790
<b>ECLASS 8.1</b>	27272790
<b>ECLASS 9.0</b>	27272792
<b>ECLASS 10.0</b>	27272792
<b>ECLASS 11.0</b>	27272792
<b>ECLASS 12.0</b>	27272792
<b>ETIM 5.0</b>	EC011349
<b>ETIM 6.0</b>	EC011349
<b>ETIM 7.0</b>	EC011349
<b>ETIM 8.0</b>	EC011349
<b>UNSPSC 16.0901</b>	46171620

### Dimensional drawing

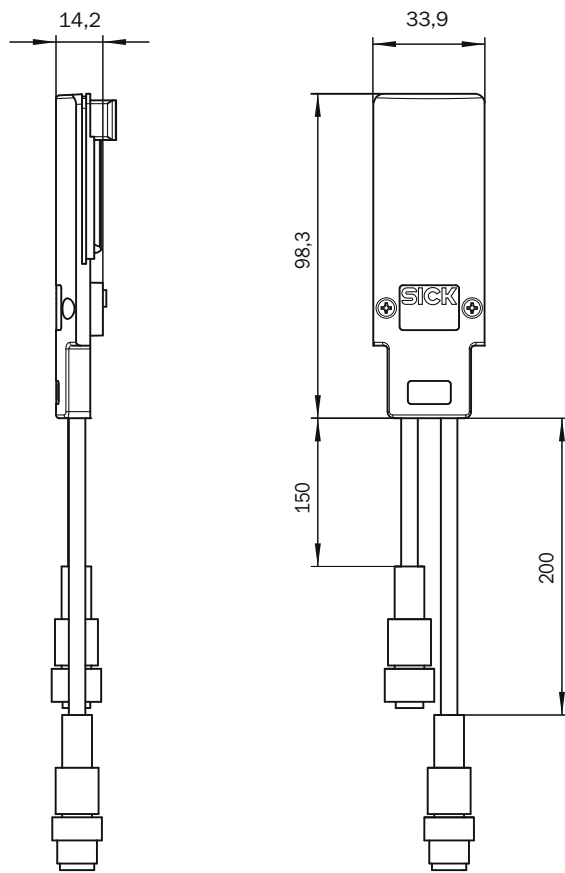

Dimensions in mm (inch)

### Pinouts deTem4 A/P system connection

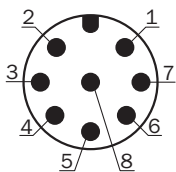

Pin	Active unit
1	In3RESOverride
2	+24 V DC
3	MFP3ADO
4	In4EDMMuting
5	OSSD1
6	OSSD2
7	0 V DC
8	N. c.

For details see operating instructions

Pinouts deTec4 system connection

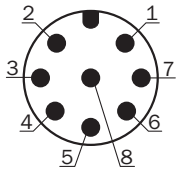

Pin	Sender	Receiver
1	N. c.	In3RESOverride
2	+24 V DC	+24 V DC
3	N. c.	MFP3ADO
4	N. c.	In4EDMMuting
5	In2Laser alignment aid button	OSSD1
6	In1Laser alignment aid switch	OSSD2
7	0 V DC	0 V DC
8	MFP1	MFP1
For details see operating instructions		

Pinouts deTem4 A/P extension connection

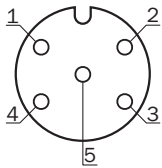

Pin	Active unit
1	+24 V Out
2	In1EDMMuting
3	0 V Out
4	In2RESMuting
5	MFP2ADOIO-Link
For details see operating instructions	

Pinouts deTec4 extension connection

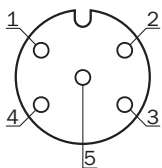







Pin	Sender	Receiver
1	+24 V Out	+24 V Out
2	N. c.	In1EDMMuting

Pin	Sender	Receiver
3	0 V Out	0 V Out
4	Sync-Out	In2RESMuting
5	MFP2	MFP2ADOIO-Link
For details see operating instructions		

### Recommended accessories

Other models and accessories → [www.sick.com/System\\_plugs\\_deTec\\_and\\_deTem](http://www.sick.com/System_plugs_deTec_and_deTem)

	Brief description	Type	part no.
connectors and cables			
	<ul style="list-style-type: none"> <li><b>Description:</b> Unshielded</li> <li><b>Connection type head A:</b> Female connector, M12, 8-pin, A-coded</li> <li><b>Connection type head B:</b> Female connector, M12, 8-pin, A-coded</li> <li><b>Connection type head C:</b> Male connector, M12, 8-pin, A-coded</li> </ul>	DSC-1208T000025KMC	6058647
		IO-Link connector	2092757
		Muting connector	2092758

	Brief description	Type	part no.
network devices			
		IOLA2US-01101 (SiLink2 Master)	1061790
		SIG200-0A0G12200	1102605
		SIG200-0A0412200	1089794
		SIG200-0A0512200	1089796

## SICK AT A GLANCE

SICK is one of the leading manufacturers of intelligent sensors and sensor solutions for industrial applications. A unique range of products and services creates the perfect basis for controlling processes securely and efficiently, protecting individuals from accidents and preventing damage to the environment.

We have extensive experience in a wide range of industries and understand their processes and requirements. With intelligent sensors, we can deliver exactly what our customers need. In application centers in Europe, Asia and North America, system solutions are tested and optimized in accordance with customer specifications. All this makes us a reliable supplier and development partner.

Comprehensive services complete our offering: SICK LifeTime Services provide support throughout the machine life cycle and ensure safety and productivity.

For us, that is “Sensor Intelligence.”

## WORLDWIDE PRESENCE:

Contacts and other locations –[www.sick.com](http://www.sick.com)