



# BEF-KHZ-RC1-25

Brackets

**MOUNTING SYSTEMS**

**SICK**  
Sensor Intelligence.



### Ordering information

Type	part no.
BEF-KHZ-RC1-25	2077685

Other models and accessories → [www.sick.com/Brackets](http://www.sick.com/Brackets)

### Detailed technical data

#### Features

<b>Accessory group</b>	Mounting systems
<b>Accessory family</b>	Brackets
<b>Description</b>	Mounting bracket on round body cylinder with piston diameter of 1 mm ... 25 mm, ambient temperature min -30 °C max 80 °C
<b>Suitable for</b>	C-slot
<b>Material</b>	Stainless steel, Aluminum
<b>Packing unit</b>	1 piece
<b>Mounting system type</b>	Brackets

#### Classifications

<b>ECLASS 5.0</b>	27279202
<b>ECLASS 5.1.4</b>	27279202
<b>ECLASS 6.0</b>	27279202
<b>ECLASS 6.2</b>	27279202
<b>ECLASS 7.0</b>	27279202
<b>ECLASS 8.0</b>	27279202
<b>ECLASS 8.1</b>	27279202
<b>ECLASS 9.0</b>	27273701
<b>ECLASS 10.0</b>	27273701
<b>ECLASS 11.0</b>	27273701
<b>ECLASS 12.0</b>	27273701
<b>ETIM 5.0</b>	EC002024
<b>ETIM 6.0</b>	EC002024
<b>ETIM 7.0</b>	EC002024
<b>ETIM 8.0</b>	EC002024
<b>UNSPSC 16.0901</b>	32131023

Dimensional drawing

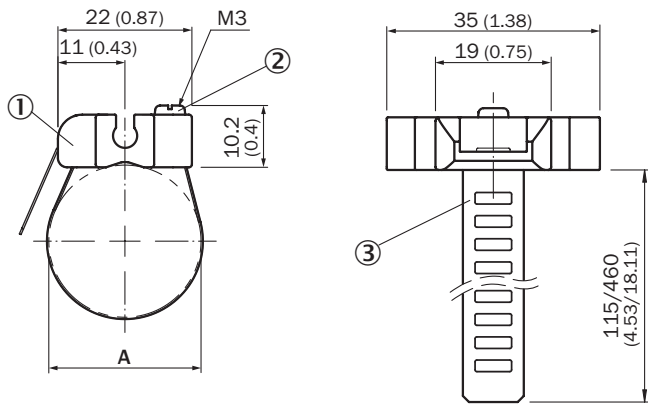

Dimensions in mm (inch)

- ① Sensoradapter with C-slot for round body cylinder
- ② Fixing screw
- ③ Strap

2077673	BEF-KHZ-RC1-25	8 ... 25
2077672	BEF-KHZ-RC1-130	8 ... 130

## SICK AT A GLANCE

SICK is one of the leading manufacturers of intelligent sensors and sensor solutions for industrial applications. A unique range of products and services creates the perfect basis for controlling processes securely and efficiently, protecting individuals from accidents and preventing damage to the environment.

We have extensive experience in a wide range of industries and understand their processes and requirements. With intelligent sensors, we can deliver exactly what our customers need. In application centers in Europe, Asia and North America, system solutions are tested and optimized in accordance with customer specifications. All this makes us a reliable supplier and development partner.

Comprehensive services complete our offering: SICK LifeTime Services provide support throughout the machine life cycle and ensure safety and productivity.

For us, that is “Sensor Intelligence.”

## WORLDWIDE PRESENCE:

Contacts and other locations –[www.sick.com](http://www.sick.com)