



KUP-0606-BP

Shaft couplings

SHAFT ADAPTATION

SICK
Sensor Intelligence.



Ordering information

Type	part no.
KUP-0606-BP	2075379

Other models and accessories → www.sick.com/Shaft_couplings

Detailed technical data

Features

Product segment	Shaft adaptation
Product	Shaft couplings
Shaft diameter D1	6 mm
Shaft diameter D2	6 mm
Coupling	Bellows coupling
Mounting system type	Key
Length	29 mm
Maximum speed	10,000 min ⁻¹
Maximum shaft offset - angular	± 4°
Max. torque	120 Ncm
Description	Bellows coupling, shaft diameter 6 mm / 6 mm, maximum shaft offset: radial ± 0.25 mm, axial ± 0.4 mm, angular +/- 4°; max. speed 10,000 rpm, -30 °C to +120 °C, max. torque 120 Ncm; material: stainless steel bellows, aluminum hub, for use with feather key

Classifications

ECLASS 5.0	23031090
ECLASS 5.1.4	23031090
ECLASS 6.0	23031090
ECLASS 6.2	23031090
ECLASS 7.0	23031090
ECLASS 8.0	23031090
ECLASS 8.1	23031090
ECLASS 9.0	23031090
ECLASS 10.0	23031090
ECLASS 11.0	23031090
ECLASS 12.0	23031090
UNSPSC 16.0901	31163014

Dimensional drawing

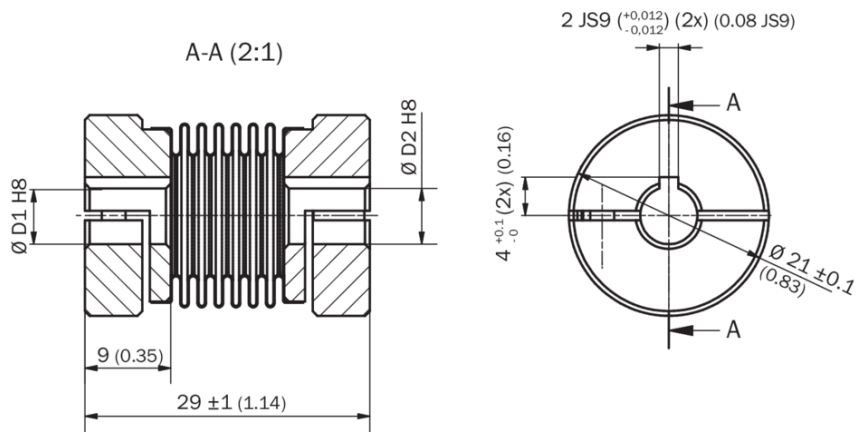

Dimensions in mm (inch)

SICK AT A GLANCE

SICK is one of the leading manufacturers of intelligent sensors and sensor solutions for industrial applications. A unique range of products and services creates the perfect basis for controlling processes securely and efficiently, protecting individuals from accidents and preventing damage to the environment.

We have extensive experience in a wide range of industries and understand their processes and requirements. With intelligent sensors, we can deliver exactly what our customers need. In application centers in Europe, Asia and North America, system solutions are tested and optimized in accordance with customer specifications. All this makes us a reliable supplier and development partner.

Comprehensive services complete our offering: SICK LifeTime Services provide support throughout the machine life cycle and ensure safety and productivity.

For us, that is “Sensor Intelligence.”

WORLDWIDE PRESENCE:

Contacts and other locations –www.sick.com