



MLG02A-0595B13201

MLG-2

AUTOMATION LIGHT GRIDS

SICK
Sensor Intelligence.



Illustration may differ

Ordering information

Type	part no.
MLG02A-0595B13201	1215371

Other models and accessories → www.sick.com/MLG-2



Detailed technical data

Features

Device version	Pro - Extended functionality										
Sensor principle	Sender/receiver										
Minimum detectable object (MDO)	2.5 mm ¹⁾ 4.5 mm ²⁾ ³⁾										
Beam separation	2.5 mm										
Type of synchronization	Cable										
Number of beams	239										
Detection height	595 mm										
Software features (default)	<table border="0"> <tr> <td>Q_{A1}</td> <td>Number of broken beams/NBB</td> </tr> <tr> <td>Q_{A2}</td> <td>Height measurement (last beam)/LBB</td> </tr> <tr> <td>Q₁</td> <td>Presence detection</td> </tr> <tr> <td>Q2 / IN</td> <td>Teach input</td> </tr> <tr> <td>Teach</td> <td>Standard mode</td> </tr> </table>	Q _{A1}	Number of broken beams/NBB	Q _{A2}	Height measurement (last beam)/LBB	Q ₁	Presence detection	Q2 / IN	Teach input	Teach	Standard mode
Q _{A1}	Number of broken beams/NBB										
Q _{A2}	Height measurement (last beam)/LBB										
Q ₁	Presence detection										
Q2 / IN	Teach input										
Teach	Standard mode										
Operating mode	<table border="0"> <tr> <td>Standard</td> <td>✓</td> </tr> <tr> <td>Transparent</td> <td>✓</td> </tr> </table>	Standard	✓	Transparent	✓						
Standard	✓										
Transparent	✓										

¹⁾ MDO min. detectable object at high measurement accuracy.

²⁾ MDO min. detectable object for standard measurement accuracy.

³⁾ Depending on beam separation without cross beam setting.

Function	Dust- and sunlight-resistant	✓
	Cross beam	✓
	Beam blanking	✓
	High-speed scan	✓
	High measurement accuracy	✓
Applications	Switching output	Object detection/object width Object recognition Height classification Hole detection/hole size Outside/inside dimension Object position Hole position Zone definition
	Data interface	Object detection Hole detection Object height measurement Measurement of the outside dimension Measurement of the inside dimension Measurement of the object position Measurement of the hole position
Included with delivery		1 × sender 1 × receiver 4/6 × QuickFix brackets (6 × QuickFix brackets for monitoring heights above 2 m) 1 × Quick Start Guide

1) MDO min. detectable object at high measurement accuracy.

2) MDO min. detectable object for standard measurement accuracy.

3) Depending on beam separation without cross beam setting.

Mechanics/electronics

Light source	LED, Infrared light
Wave length	850 nm
Supply voltage V_s	DC 19.2 V ... 28.8 V ¹⁾
Power consumption sender	66.95 mA ²⁾
Power consumption receiver	167.8 mA ²⁾
Ripple	< 5 V _{pp}
Output current I_{max}	100 mA
Output load, capacitive	100 nF
Output load, Inductive	1 H
Initialization time	< 1 s
Switching output	Push-pull: PNP/NPN
Connection type	Plug, M12, 5-pin, 0.22 m Male connector M12, 8-pin, 0.27 m M12 female connector, 4-pin, D-coded, 0.19 m
Housing material	Aluminum
Display	LED

1) Without load.

2) Without load with 24 V.

3) Operating in outdoor condition only with a external protection housing.

Enclosure rating	IP65, IP67 3)
Circuit protection	U _V connections, reverse polarity protected Output Q short-circuit protected Interference pulse suppression
Protection class	III
Weight	1.449 kg
Front screen	PMMA
Option	None
UL File No.	NRKH.E181493

1) Without load.

2) Without load with 24 V.

3) Operating in outdoor condition only with a external protection housing.

Performance

Maximum range	2.8 m ¹⁾
Minimum range	≥ 0 m
Operating range	2 m
Response time	19.7 ms ²⁾

1) No reserve for environmental issue and deterioration of the diode.

2) Without high speed.

Interfaces

IO-Link	✓, IO-Link V1.1
Data transmission rate	230,4 kbit/s (COM3)
Maximum cable length	20 m
Cycle time	2.3 ms
VendorID	26
DeviceID HEX	800068
DeviceID DEC	8388712
Process data length	32 Byte (TYPE_2_V) ¹⁾
Analog	✓, Current
Inputs/outputs	2 x analog + 2 x Q (IO-Link)
Analog output (current)	4 mA ... 20 mA
Analog output	Q _{A1} , Q _{A2}
Number	2
Type	Current output
Current	4 mA ... 20 mA
Digital output	Q ₁ , Q ₂
Number	2
Digital input	In ₁
Number	1

1) For an IO-Link master with V1.0, reverts to interleaved mode (consisting of TYPE_1_1 (ProcessData) and TYPE_1_2 (on-request data)).

Ambient data

Shock resistance	Continuous shocks 10 g, 16 ms, 1000 shocks Single shocks 15 g, 11 ms 3 per axle
Vibration resistance	Sinusoidal oscillation 10-150 Hz 5 g
EMC	EN 60947-5-2
Ambient light immunity	Direct: 150,000 lx ¹⁾ Indirect: 200,000 lx ²⁾
Ambient operating temperature	-30 °C ... +55 °C
Ambient temperature, storage	-40 °C ... +70 °C

¹⁾ Outdoor mode.

²⁾ Light resistance indirect.

Smart Task

Smart Task name	Base logics
------------------------	-------------

Certificates

EU declaration of conformity	✓
UK declaration of conformity	✓
ACMA declaration of conformity	✓
Moroccan declaration of conformity	✓
cULus certificate	✓
IO-Link certificate	✓
Photobiological safety (IEC EN 62471)	✓

Classifications

ECLASS 5.0	27270910
ECLASS 5.1.4	27270910
ECLASS 6.0	27270910
ECLASS 6.2	27270910
ECLASS 7.0	27270910
ECLASS 8.0	27270910
ECLASS 8.1	27270910
ECLASS 9.0	27270910
ECLASS 10.0	27270910
ECLASS 11.0	27270910
ECLASS 12.0	27270910
ETIM 5.0	EC002549
ETIM 6.0	EC002549
ETIM 7.0	EC002549
ETIM 8.0	EC002549
UNSPSC 16.0901	39121528

Dimensional drawing



	A ¹⁾	B ²⁾
Strahlabstand 2,5 mm	62,25	17,15
Strahlabstand 5 mm	63,3	16,1
Strahlabstand 10 mm	68,3	16,1
Strahlabstand 20 mm	68,3/78,3 ³⁾	16,1
Strahlabstand 25 mm	83,3	16,1
Strahlabstand 30 mm	88,3	16,1
Strahlabstand 50 mm	108,3	16,1

¹⁾ Abstand: MLG-2 Kante - erster Strahl

²⁾ Abstand: MLG-2 Kante - letzter Strahl

³⁾ MLG20x-xx**40**: 68,3 mm

MLG20x-xx**80**: 78,3 mm

Dimensions in mm (inch)

- ① First beam
- ② last beam
- ③ detection height (see technical data)
- ④ Beam separation
- ⑤ Optical axis
- ⑥ status indicator: green, yellow, red LEDs
- ⑦ Connection

Connection type and diagram Connector M12, 5/8-pin, analog outputs Q_A

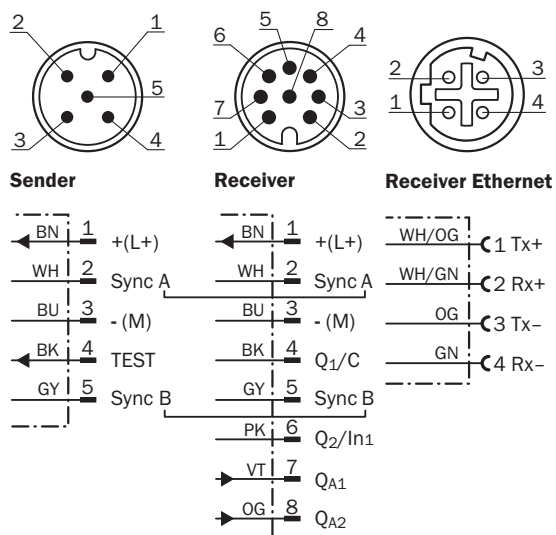

Pinouts



- ① Connection cable receiver (2096010)
- ② T-piece
- ③ Connection cable (6020664)
- ④ Ethernet Connection cable

Adjustments



① status indicator: green, yellow, red LEDs

Connection diagram T-splitter, IO-Link Master



Connection diagram T-splitter, PLC



Recommended accessories

Other models and accessories → www.sick.com/MLG-2

	Brief description	Type	part no.
connectors and cables			
	<ul style="list-style-type: none"> Description: Unshielded Connection type head A: Female connector, M12, 5-pin, A-coded Connection type head B: Female connector, M12, 8-pin, A-coded Connection type head C: Male connector, M12, 8-pin, A-coded Note: For connecting of a PLC 	SBO-02F12-SM1	6053172
	<ul style="list-style-type: none"> Description: Sensor/actuator cable, special color code, shielded Connection type head A: Female connector, M12, 8-pin, straight Connection type head B: Flying leads Signal type: Sensor/actuator cable Cable: 5 m, 8-wire, PVC Connection systems: Flying leads Application: Uncontaminated zones, Zones with chemicals 	DOL-1208-G05MF	6020664
	<ul style="list-style-type: none"> Description: Sensor/actuator cable, unshielded Connection type head A: Female connector, M12, 5-pin, straight, A-coded Connection type head B: Male connector, M12, 5-pin, straight, A-coded Signal type: Sensor/actuator cable Cable: 5 m, 5-wire, PUR, halogen-free Application: Drag chain operation, Zones with oils and lubricants, Robot, Drag chain operation 	YF2A15-050UB5M2A15	2096010
	<ul style="list-style-type: none"> Connection type head A: Male connector, M12, 4-pin, straight, D-coded Connection type head B: Male connector, RJ45, 4-pin, straight Signal type: Ethernet, PROFINET Cable: 5 m, 4-wire, PUR, halogen-free Description: Ethernet, shielded, PROFINET Application: Drag chain operation, Zones with oils and lubricants 	YM2D24-050P-N1MRJA4	2106184

	Brief description	Type	part no.
network devices			
		SIG350-0004AP100	6076871
		SIG350-0006AP100	6076924
		SIG350-0005AP100	6076923

SICK AT A GLANCE

SICK is one of the leading manufacturers of intelligent sensors and sensor solutions for industrial applications. A unique range of products and services creates the perfect basis for controlling processes securely and efficiently, protecting individuals from accidents and preventing damage to the environment.

We have extensive experience in a wide range of industries and understand their processes and requirements. With intelligent sensors, we can deliver exactly what our customers need. In application centers in Europe, Asia and North America, system solutions are tested and optimized in accordance with customer specifications. All this makes us a reliable supplier and development partner.

Comprehensive services complete our offering: SICK LifeTime Services provide support throughout the machine life cycle and ensure safety and productivity.

For us, that is “Sensor Intelligence.”

WORLDWIDE PRESENCE:

Contacts and other locations –www.sick.com