



# DAXLAN-0350BA0C0000E00

DAX

MAGNETOSTRICTIVE LINEAR ENCODERS

**SICK**  
Sensor Intelligence.



Illustration may differ

### Ordering information

Type	part no.
DAXLAN-0350BA0C0000E00	1133242

Other models and accessories → [www.sick.com/DAX](http://www.sick.com/DAX)



### Detailed technical data

#### Safety-related parameters

<b>MTTF<sub>D</sub> (mean time to dangerous failure)</b>	123 years <sup>1)</sup>
--	-------------------------

<sup>1)</sup> This product is a standard product and does not constitute a safety component as defined in the Machinery Directive. Calculation based on nominal load of components, average ambient temperature 40°C, frequency of use 8760 h/a. All electronic failures are considered hazardous. For more information, see document no. 8015532.

#### Performance

<b>Linearity</b>	≤ 0.03% F.S. (Minimum 90 μm) <sup>1) 2)</sup>
<b>Repeatability</b>	≤ ± 20 μm
<b>Measured values</b>	Positioning
<b>Measuring range</b>	0 mm ... 350 mm
<b>Unusable range</b>	
Null zone	55 mm
Damping zone	63 mm
<b>Magnet type</b>	
Magnet shape	Small block magnet
Configured for number of magnets	1 piece
<b>Magnet travel speed</b>	Any
<b>Measuring frequency (internal)</b>	< 2 ms

<sup>1)</sup> Systematic position measurement deviation according to DIN ISO 1319-1 (value includes all systematic errors or deviations from the actual position value, e.g. repeatability and hysteresis).

<sup>2)</sup> In principle, the size of the measurement deviation is limited by the resolution of the interface.

#### Interfaces

<b>Communication interface</b>	Analog
<b>Communication Interface detail</b>	Current
<b>Output signal</b>	4 mA ... 20 mA
<b>Signals</b>	
Number of signals	Two output signals (one output signal + an inverted second output signal)
Sequence of signals	Signal 1: rising, signal 2: falling
<b>Load resistance</b>	100 Ω ... 500 Ω

## Electronics

<b>Connection type</b>	Male connector, M12, 5-pin
<b>Pinouts</b>	1=+24 V DC; 2=Signal 1; 3=Power ground; 4=Signal 2; 5=Output signal ground (0 V)
<b>Male connector coding</b>	A-coded
<b>Supply voltage</b>	24 V DC ( $\pm 20\%$ )
<b>Current consumption</b>	50...100 mA
<b>Reverse polarity protection</b>	Up to $-30$ V DC
<b>Residual ripple</b>	$\leq 0.28$ V <sub>pp</sub>
<b>Dielectric strength</b>	500 V DC, 0 V against housing
<b>Over voltage protection</b>	$\leq 36$ V DC

## Mechanics

<b>Mechanical design</b>	DAX Low Profile
<b>Material</b>	
Housing	Aluminum (anodised), zinc, stainless steel, brass
Mounting bracket	Stainless steel 1.4301

## Ambient data

<b>EMC</b>	According to EN 61000-6-2 and EN 61000-6-4
<b>Enclosure rating</b>	IP65 / IP67 <sup>1)</sup>
<b>Temperature</b>	
Operating temperature range	$-40$ °C ... $+85$ °C
Storage temperature range	$-40$ °C ... $+85$ °C
<b>Permissible relative humidity</b>	90 % (Condensation not permitted)
<b>Resistance to shocks</b>	100 g, 6 ms (IEC 60068-2-27)
<b>Resistance to vibration</b>	8 g / 10...2,000 Hz according to IEC 60068-2-6 <sup>2)</sup>

<sup>1)</sup> In correctly assembled mating connector.

<sup>2)</sup> Resonance frequencies can influence signal quality.

## General notes

<b>Items supplied</b>	Mounting brackets enclosed, mounting material for base not included. Position magnet not included.
-----------------------	---

## Certificates

<b>EU declaration of conformity</b>	✓
<b>UK declaration of conformity</b>	✓
<b>ACMA declaration of conformity</b>	✓
<b>Moroccan declaration of conformity</b>	✓
<b>China RoHS</b>	✓
<b>cULus certificate</b>	✓
<b>Information according to Art. 3 of Data Act (Regulation EU 2023/2854)</b>	✓

## Classifications

<b>ECLASS 5.0</b>	27270705
-------------------	----------

<b>ECLASS 5.1.4</b>	27270705
<b>ECLASS 6.0</b>	27270705
<b>ECLASS 6.2</b>	27270705
<b>ECLASS 7.0</b>	27270705
<b>ECLASS 8.0</b>	27270705
<b>ECLASS 8.1</b>	27270705
<b>ECLASS 9.0</b>	27270705
<b>ECLASS 10.0</b>	27270705
<b>ECLASS 11.0</b>	27270705
<b>ECLASS 12.0</b>	27274304
<b>ETIM 5.0</b>	EC002544
<b>ETIM 6.0</b>	EC002544
<b>ETIM 7.0</b>	EC002544
<b>ETIM 8.0</b>	EC002544
<b>UNSPSC 16.0901</b>	41111613

### DAX Low Profile



Dimensions in mm (inch)

① Measuring range

Dimensional drawing Block magnet MAG-B-180-xx

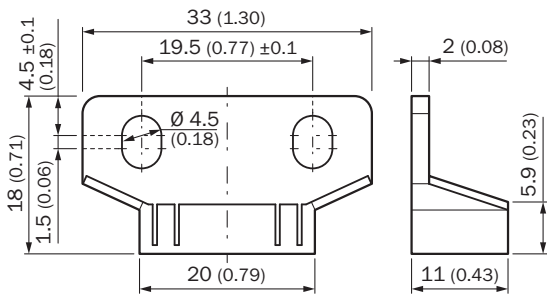

Dimensions in mm (inch)

positioning of mounting bracket

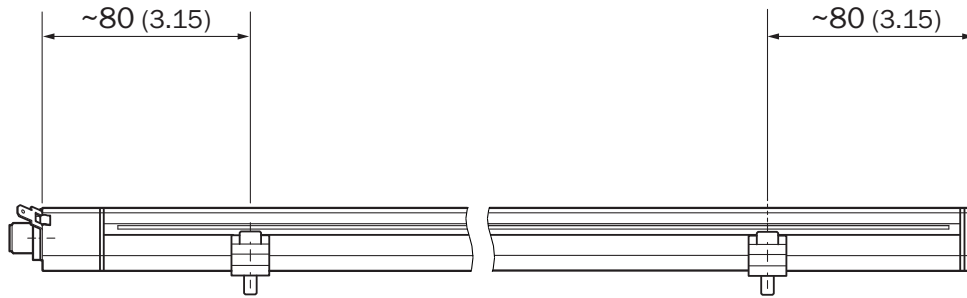

Dimensions in mm (inch)

distance of position magnets

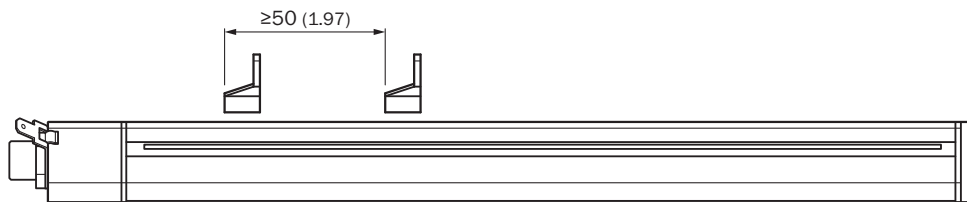

Dimensions in mm (inch)

distance tolerance

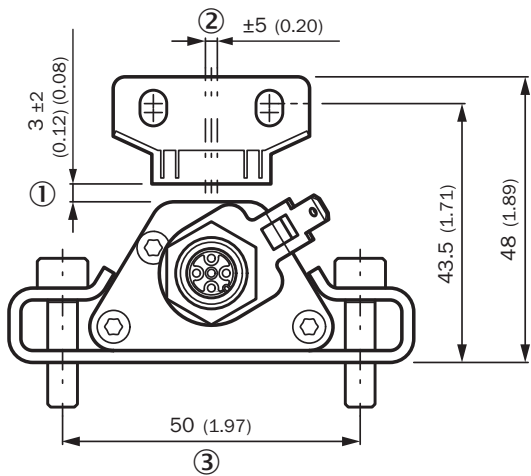

Dimensions in mm (inch)

- ① nominal distance + permissible amount of distance tolerance
- ② permissible center offset
- ③ recommendation: M5 x 20

Anschlussbelegung







Plug, M12, 5-pin	Signal
1	+24 V DC

Plug, M12, 5-pin	Signal
2	Signal 1
3	Power Ground
4	Signal 2
5	Output signal ground (0 V)

### Recommended accessories

Other models and accessories → [www.sick.com/DAX](http://www.sick.com/DAX)

	Brief description	Type	part no.
<b>Mounting systems</b>			
	<ul style="list-style-type: none"> <li><b>Description:</b> Replacement clamping bracket for DAX® Low Profile without fastening material</li> <li><b>Dimensions (W x H x L):</b> 15 mm x 16 mm x 68 mm</li> <li><b>Color:</b> Metallic</li> <li><b>Items supplied:</b> 2 pieces</li> </ul>	BEF-KH-LP1-02	2125244
	<ul style="list-style-type: none"> <li><b>Description:</b> Replacement clamping bracket for DAX® Low Profile without fastening material</li> <li><b>Dimensions (W x H x L):</b> 15 mm x 16 mm x 68 mm</li> <li><b>Color:</b> Metallic</li> <li><b>Items supplied:</b> 3 pieces</li> </ul>	BEF-KH-LP1-03	2125245
	<ul style="list-style-type: none"> <li><b>Description:</b> Replacement clamping bracket for DAX® Low Profile without fastening material</li> <li><b>Dimensions (W x H x L):</b> 15 mm x 16 mm x 68 mm</li> <li><b>Color:</b> Metallic</li> <li><b>Items supplied:</b> 4 pieces</li> </ul>	BEF-KH-LP1-04	2125246
<b>magnets</b>			
	<ul style="list-style-type: none"> <li><b>Product segment:</b> Magnets</li> <li><b>Product:</b> Position magnets</li> <li><b>Description:</b> Small block magnet for magnetostrictive linear encoders</li> </ul>	MAG-B-180-01	2129171

	Brief description	Type	part no.
connectors and cables			
	<ul style="list-style-type: none"> <li><b>Description:</b> Unshielded</li> <li><b>Connection type head A:</b> Female connector, M12, 5-pin, straight, A-coded</li> <li><b>Connection systems:</b> Screw-type terminals</li> <li><b>Permitted cross-section:</b> ≤ 0.75 mm<sup>2</sup></li> </ul>	DOS-1205-G	6009719
	<ul style="list-style-type: none"> <li><b>Description:</b> Unshielded</li> <li><b>Connection type head A:</b> Male connector, M12, 5-pin, straight, A-coded</li> <li><b>Connection systems:</b> Screw-type terminals</li> <li><b>Permitted cross-section:</b> ≤ 0.75 mm<sup>2</sup></li> <li><b>Note:</b> For field bus technology</li> </ul>	STE-1205-G	6022083
	<ul style="list-style-type: none"> <li><b>Description:</b> Sensor/actuator cable, shielded</li> <li><b>Connection type head A:</b> Female connector, M12, 5-pin, straight, A-coded</li> <li><b>Connection type head B:</b> Flying leads</li> <li><b>Signal type:</b> Sensor/actuator cable</li> <li><b>Cable:</b> 1.5 m, 5-wire, PUR, halogen-free</li> <li><b>Application:</b> Drag chain operation, Zones with oils and lubricants, Robot, Drag chain operation</li> </ul>	YF2A25-015UB6XLEAX	2095833
	<ul style="list-style-type: none"> <li><b>Description:</b> Sensor/actuator cable, shielded</li> <li><b>Connection type head A:</b> Female connector, M12, 5-pin, straight, A-coded</li> <li><b>Connection type head B:</b> Flying leads</li> <li><b>Signal type:</b> Sensor/actuator cable</li> <li><b>Cable:</b> 3 m, 5-wire, PUR, halogen-free</li> <li><b>Application:</b> Drag chain operation, Zones with oils and lubricants, Robot, Drag chain operation</li> </ul>	YF2A25-030UB6XLEAX	2095834
	<ul style="list-style-type: none"> <li><b>Description:</b> Sensor/actuator cable, shielded</li> <li><b>Connection type head A:</b> Female connector, M12, 5-pin, angled, A-coded</li> <li><b>Connection type head B:</b> Flying leads</li> <li><b>Signal type:</b> Sensor/actuator cable</li> <li><b>Cable:</b> 3 m, 5-wire, PUR, halogen-free</li> <li><b>Application:</b> Drag chain operation, Zones with oils and lubricants, Robot, Drag chain operation</li> </ul>	YG2A25-030UB6XLEAX	2095791
	<ul style="list-style-type: none"> <li><b>Description:</b> Sensor/actuator cable, shielded</li> <li><b>Connection type head A:</b> Female connector, M12, 5-pin, angled, A-coded</li> <li><b>Connection type head B:</b> Flying leads</li> <li><b>Signal type:</b> Sensor/actuator cable</li> <li><b>Cable:</b> 5 m, 5-wire, PUR, halogen-free</li> <li><b>Application:</b> Drag chain operation, Zones with oils and lubricants, Robot, Drag chain operation</li> </ul>	YG2A25-050UB6XLEAX	2095792
	<ul style="list-style-type: none"> <li><b>Description:</b> Sensor/actuator cable, shielded</li> <li><b>Connection type head A:</b> Female connector, M12, 5-pin, angled, A-coded</li> <li><b>Connection type head B:</b> Flying leads</li> <li><b>Signal type:</b> Sensor/actuator cable</li> <li><b>Cable:</b> 10 m, 5-wire, PUR, halogen-free</li> <li><b>Application:</b> Drag chain operation, Zones with oils and lubricants, Robot, Drag chain operation</li> </ul>	YG2A25-100UB6XLEAX	2095793
	<ul style="list-style-type: none"> <li><b>Description:</b> Sensor/actuator cable, shielded</li> <li><b>Connection type head A:</b> Female connector, M12, 5-pin, angled, A-coded</li> <li><b>Connection type head B:</b> Flying leads</li> <li><b>Signal type:</b> Sensor/actuator cable</li> <li><b>Cable:</b> 0.6 m, 5-wire, PUR, halogen-free</li> <li><b>Application:</b> Drag chain operation, Zones with oils and lubricants, Robot, Drag chain operation</li> </ul>	YG2A25-C60UB6XLEAX	2145612
	<ul style="list-style-type: none"> <li><b>Description:</b> Sensor/actuator cable, shielded</li> <li><b>Connection type head A:</b> Female connector, M12, 5-pin, angled, A-coded</li> <li><b>Connection type head B:</b> Flying leads</li> <li><b>Signal type:</b> Sensor/actuator cable</li> <li><b>Cable:</b> 1 m, 5-wire, PUR, halogen-free</li> <li><b>Application:</b> Drag chain operation, Zones with oils and lubricants, Robot, Drag chain operation</li> </ul>	YG2A25-010UB6XLEAX	2145613
	<ul style="list-style-type: none"> <li><b>Description:</b> Sensor/actuator cable, shielded</li> <li><b>Connection type head A:</b> Female connector, M12, 5-pin, angled, A-coded</li> <li><b>Connection type head B:</b> Flying leads</li> <li><b>Signal type:</b> Sensor/actuator cable</li> <li><b>Cable:</b> 2 m, 5-wire, PUR, halogen-free</li> <li><b>Application:</b> Drag chain operation, Zones with oils and lubricants, Robot, Drag chain operation</li> </ul>	YG2A25-020UB6XLEAX	2145614

## SICK AT A GLANCE

SICK is one of the leading manufacturers of intelligent sensors and sensor solutions for industrial applications. A unique range of products and services creates the perfect basis for controlling processes securely and efficiently, protecting individuals from accidents and preventing damage to the environment.

We have extensive experience in a wide range of industries and understand their processes and requirements. With intelligent sensors, we can deliver exactly what our customers need. In application centers in Europe, Asia and North America, system solutions are tested and optimized in accordance with customer specifications. All this makes us a reliable supplier and development partner.

Comprehensive services complete our offering: SICK LifeTime Services provide support throughout the machine life cycle and ensure safety and productivity.

For us, that is “Sensor Intelligence.”

## WORLDWIDE PRESENCE:

Contacts and other locations –[www.sick.com](http://www.sick.com)