



WTV4FE-5G311A0ZZZ

W4

PHOTOELECTRIC SENSORS

SICK
Sensor Intelligence.



Illustration may differ



Ordering information

Type	part no.
WTV4FE-5G3111A0ZZZ	1125733

Other models and accessories → www.sick.com/W4

Detailed technical data

Features

Functional principle	Photoelectric proximity sensor
Functional principle detail	Background suppression, V-optics
Sensing range	
Sensing range min.	4 mm
Sensing range max.	22 mm
Emitted beam	
Light source	PinPoint LED
Type of light	Visible red light
Shape of light spot	Rectangular
Light spot size (distance)	0.5 mm x 1.9 mm (30 mm)
Maximum dispersion of the emitted beam around the standardized transmission axis (squint angle)	< +/- 1.5° (at T _U = +23 °C)
Key LED figures	
Normative reference	EN 62471:2008-09 IEC 62471:2006, modified
LED risk group marking	Free group
Wave length	635 nm
Average service life	100,000 h at T _a = +25 °C
Smallest detectable object (MDO) typ.	0.1 mm, At 30 mm distance (object with 90% remission (complies with standard white according to DIN 5033))

Adjustment	None	-
Display	LED green	Operating indicator Static on: power on
	LED yellow	Status of received light beam Static on: object present Static off: object not present
Special features		Sensing range preset: 22 mm
Special applications		Detecting transparent objects

Safety-related parameters

MTTF_D	683 years
DC_{avg}	0%
T_M (mission time)	20 years

Electronics

Supply voltage U_B	10 V DC ... 30 V DC ¹⁾
Ripple	≤ 5 V _{pp}
Usage category	DC-12 (According to EN 60947-5-2) DC-13 (According to EN 60947-5-2)
Current consumption	≤ 25 mA, without load. At U _B = 24 V
Protection class	III
Digital output	
Number	1
Type	Push-pull: PNP/NPN
Switching mode	Light switching
Signal voltage PNP HIGH/LOW	Approx. U _B -2.5 V / 0 V
Signal voltage NPN HIGH/LOW	Approx. U _B / < 2.5 V
Output current I _{max.}	≤ 100 mA
Circuit protection outputs	Reverse polarity protected Overcurrent protected Short-circuit protected
Response time	≤ 500 μs
Repeatability (response time)	150 μs ²⁾
Switching frequency	1,000 Hz ³⁾
Pin/Wire assignment	
Function of pin 4/black (BK)	Digital output, light switching, object present → output Q HIGH ⁴⁾

¹⁾ Limit values.

²⁾ Signal transit time with resistive load in switching mode.

³⁾ With light/dark ratio 1:1.

⁴⁾ This switching output must not be connected to another output.

Mechanics

Housing	Rectangular
Design detail	Flat

Dimensions (W x H x D)	16 mm x 40.1 mm x 12.1 mm
Connection	Cable, 3-wire, 3 m
Connection detail	
Deep-freeze property	Do not bend below 0 °C
Conductor size	0.14 mm ²
Cable diameter	Ø 3.4 mm
Length of cable (L)	3 m
Material	
Housing	Plastic, VISTAL®
Front screen	Plastic, PMMA
Cable	Plastic, PVC
Weight	Approx. 30 g
Maximum tightening torque of the fixing screws	0.4 Nm

Ambient data

Enclosure rating	IP66 (EN 60529) IP67 (EN 60529)
Ambient operating temperature	-40 °C ... +60 °C
Ambient temperature, storage	-40 °C ... +75 °C
Typ. Ambient light immunity	Artificial light: ≤ 50,000 lx Sunlight: ≤ 50,000 lx
Shock resistance	30 g, 11 ms (3 positive and 3 negative shocks along X, Y, Z axes, 18 total shocks (EN60068-2-27))
Vibration resistance	10 Hz ... 1,000 Hz (Amplitude 1 mm, 3 x 30 min (EN60068-2-6))
Air humidity	35 % ... 95 %, relative humidity (no condensation)
Electromagnetic compatibility (EMC)	EN 60947-5-2
Resistance to cleaning agent	ECOLAB
UL File No.	NRKH.E181493 & NRKH7.E181493

Certificates

EU declaration of conformity	✓
UK declaration of conformity	✓
ACMA declaration of conformity	✓
Moroccan declaration of conformity	✓
China RoHS	✓
ECOLAB certificate	✓
cULus certificate	✓

Classifications

ECLASS 5.0	27270904
ECLASS 5.1.4	27270904
ECLASS 6.0	27270904
ECLASS 6.2	27270904
ECLASS 7.0	27270904
ECLASS 8.0	27270904

ECLASS 8.1	27270904
ECLASS 9.0	27270904
ECLASS 10.0	27270904
ECLASS 11.0	27270904
ECLASS 12.0	27270903
ETIM 5.0	EC002719
ETIM 6.0	EC002719
ETIM 7.0	EC002719
ETIM 8.0	EC002719
UNSPSC 16.0901	39121528

display and adjustment elements

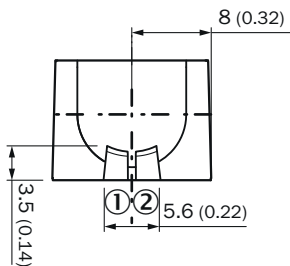

- ① LED green
- ② LED yellow

Installation note Angle of acceptance, pane of glass in front of background, β

Transparent pane of glass in front of background
 (18 % remission), angle of acceptance

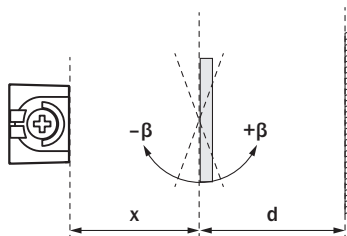
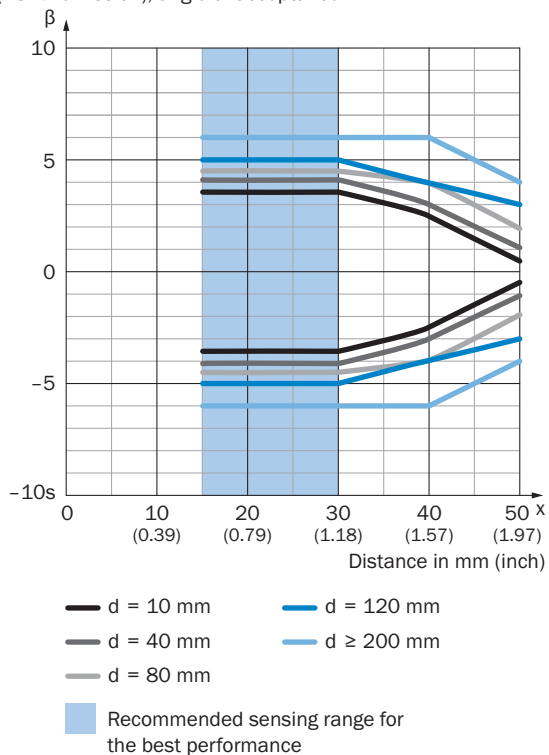

Example:
 Set sensing range $x = 30$ mm
 Distance object to background $d \geq 200$ mm
 Angle of acceptance between -6° and $+6^\circ$

Installation note Angle of acceptance, on high-glossy object, α

High-glossy object, angle of acceptance

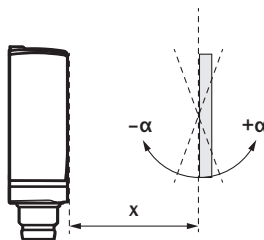
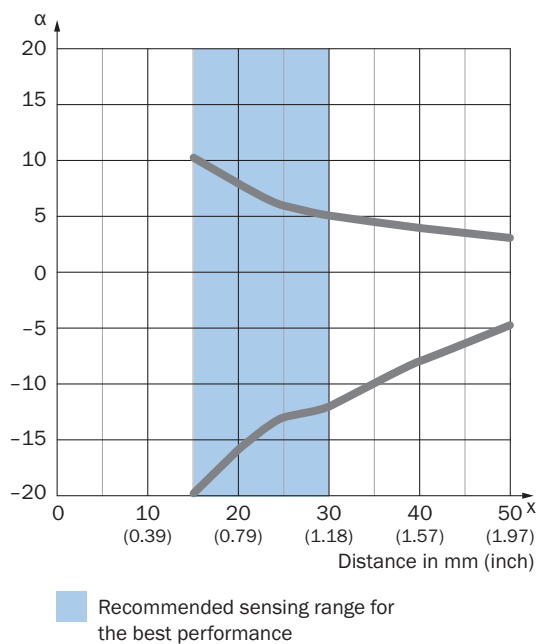

Example:
 Set sensing range $x = 30$ mm
 Angle of acceptance between -12° and $+5^\circ$

Installation note Angle of acceptance, on high-glossy object, β

High-glossy object, angle of acceptance

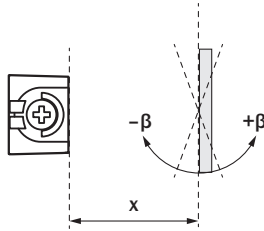
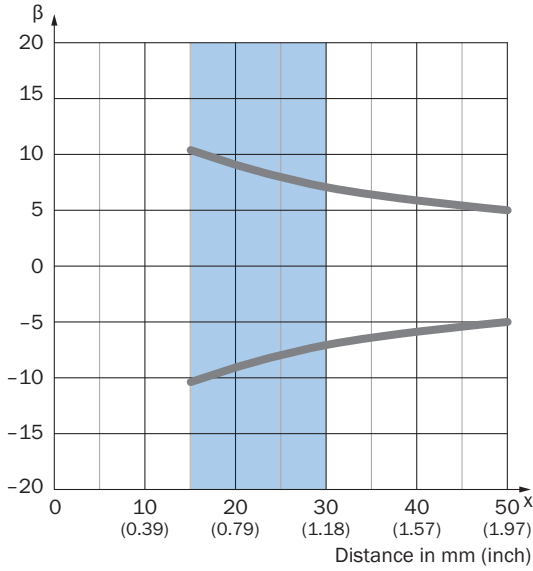

Example:
Set sensing range $x = 30 \text{ mm}$
Angle of acceptance between -7° and $+7^\circ$

Recommended sensing range for the best performance

Installation note Angle of acceptance, pane of glass in front of background, α

Transparent pane of glass in front of background (18 % remission), angle of acceptance

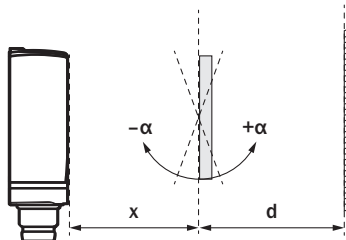
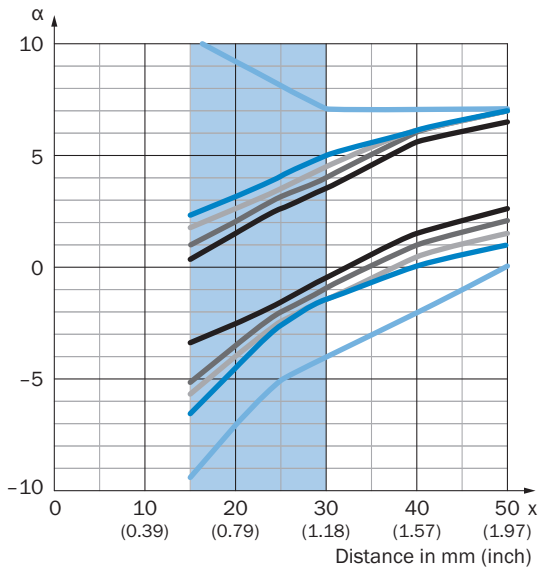

Example:
Set sensing range $x = 30 \text{ mm}$
Distance object to background $d \geq 200 \text{ mm}$
Angle of acceptance between -4° and $+7^\circ$

$d = 10 \text{ mm}$ $d = 120 \text{ mm}$
 $d = 40 \text{ mm}$ $d \geq 200 \text{ mm}$
 $d = 80 \text{ mm}$

Recommended sensing range for the best performance

Connection type Cable, 3-wire

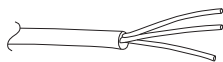

Connection diagram Cd-043

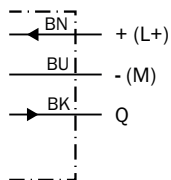

Truth table Push-pull: PNP/NPN – dark switching \bar{Q}

	Dark switching \bar{Q} (normally closed (upper switch), normally open (lower switch))	
	Object not present → Output HIGH	Object present → Output LOW
Light receive	✘	✔
Light receive indicator	✘	☀
Load resistance to L+	✘	⚡
Load resistance to M	⚡	✘

Truth table Push-pull: PNP/NPN - light switching Q

	Light switching Q (normally open (upper switch), normally closed (lower switch))	
	Object not present → Output LOW	Object present → Output HIGH
Light receive	✗	✓
Light receive indicator	✗	☀
Load resistance to L+	⚡	✗
Load resistance to M	✗	⚡

Light spot size Vertical

Dimensions in mm (inch)

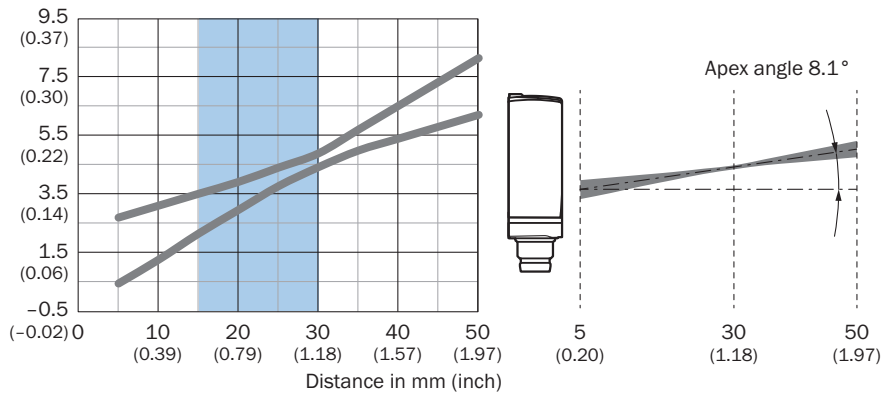

Recommended sensing range for the best performance

Light spot size Horizontal

Dimensions in mm (inch)

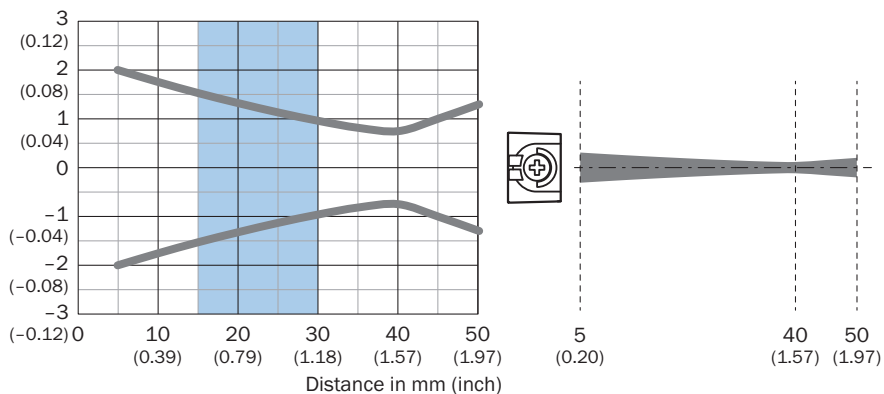

 Recommended sensing range for the best performance

Dimensional drawing

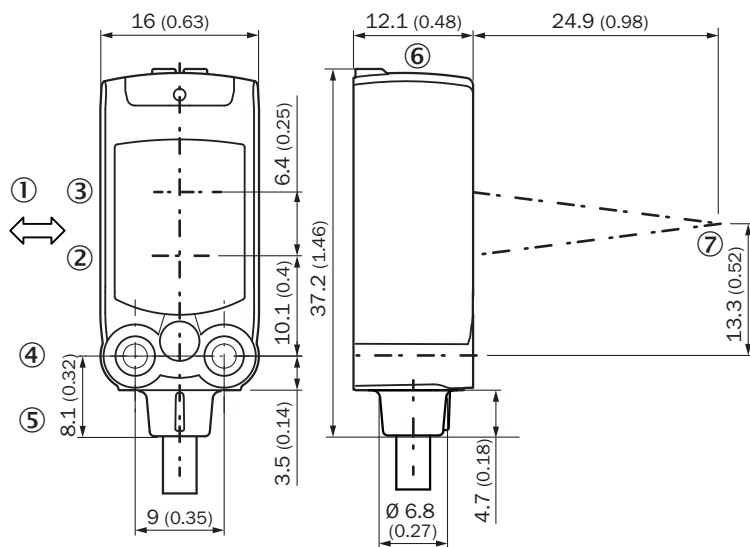





Dimensions in mm (inch)

- ① Standard direction of the material being detected
- ② Center of optical axis, sender
- ③ Center of optical axis, receiver
- ④ M3 mounting hole
- ⑤ Connection
- ⑥ display and adjustment elements
- ⑦ focus

Recommended accessories

Other models and accessories → www.sick.com/W4

	Brief description	Type	part no.
Mounting systems			
	<ul style="list-style-type: none"> Description: Mounting bracket for wall mounting Material: Stainless steel Details: Stainless steel 1.4571 Items supplied: Mounting hardware included Suitable for: W4S, W4F, W4S 	BEF-W4-A	2051628
	<ul style="list-style-type: none"> Description: Mounting bracket for floor mounting Material: Stainless steel Details: Stainless steel 1.4571 Items supplied: Mounting hardware included Suitable for: W4S, W4F, W4S 	BEF-W4-B	2051630
	<ul style="list-style-type: none"> Description: Plate N08 for universal clamp bracket Material: Steel, zinc diecast Details: Zinc plated steel (sheet), Zinc die cast (clamping bracket) Items supplied: Universal clamp (5322626), mounting hardware Usable for: W100, W150, W4S, W4F, W8, W9-3, W8G, W8 Laser, W8 Inox, G6, W100 Laser, W100-2, W10, G6 Inox, RAY10, W4SLG-3, W9, GR18, MultiPulse, Reflex Array, MultiLine, LUT3, KT5, KT8, KT10, CS8 	BEF-KHS-N08	2051607
connectors and cables			
	<ul style="list-style-type: none"> Description: Unshielded Connection type head A: Male connector, M8, 3-pin, straight, A-coded Connection systems: Screw-type terminals Permitted cross-section: 0.14 mm² ... 0.5 mm² 	STE-0803-G	6037322

SICK AT A GLANCE

SICK is one of the leading manufacturers of intelligent sensors and sensor solutions for industrial applications. A unique range of products and services creates the perfect basis for controlling processes securely and efficiently, protecting individuals from accidents and preventing damage to the environment.

We have extensive experience in a wide range of industries and understand their processes and requirements. With intelligent sensors, we can deliver exactly what our customers need. In application centers in Europe, Asia and North America, system solutions are tested and optimized in accordance with customer specifications. All this makes us a reliable supplier and development partner.

Comprehensive services complete our offering: SICK LifeTime Services provide support throughout the machine life cycle and ensure safety and productivity.

For us, that is “Sensor Intelligence.”

WORLDWIDE PRESENCE:

Contacts and other locations –www.sick.com