

# DLS40E-S3GV00200

DLS40

INCREMENTAL ENCODERS

**SICK**  
Sensor Intelligence.

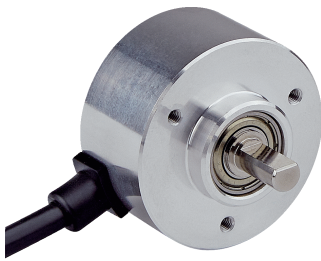

### Ordering information

Type	part no.
DLS40E-S3GV00200	1122006

Other models and accessories → [www.sick.com/DLS40](http://www.sick.com/DLS40)

Illustration may differ



### Detailed technical data

#### Safety-related parameters

<b>MTTF<sub>D</sub> (mean time to dangerous failure)</b>	600 years (EN ISO 13849-1) <sup>1)</sup>
--	--

<sup>1)</sup> This product is a standard product and does not constitute a safety component as defined in the Machinery Directive. Calculation based on nominal load of components, average ambient temperature 40 °C, frequency of use 8760 h/a. All electronic failures are considered hazardous. For more information, see document no. 8015532.

#### Performance

<b>Pulses per revolution</b>	200
<b>Measuring step</b>	90°, electric/pulses per revolution
<b>Duty cycle</b>	≤ 0.5 ± 10 %

#### Interfaces

<b>Communication interface</b>	Incremental
<b>Communication Interface detail</b>	HTL / Push pull
<b>Number of signal channels</b>	3 channel
<b>Output frequency</b>	≤ 150 kHz
<b>Load current</b>	≤ 30 mA
<b>Power consumption</b>	≤ 2 W (without load)

#### Electronics

<b>Connection type</b>	Cable, 5-wire, radial, 2 m
<b>Supply voltage</b>	10 ... 27 V
<b>Reference signal, number</b>	1
<b>Reverse polarity protection</b>	✓
<b>Short-circuit protection of the outputs</b>	✓ <sup>1)</sup>

<sup>1)</sup> Protection against short circuit to GND and U<sub>S</sub>. Short-circuit resistance is only guaranteed when U<sub>S</sub> and GND are connected correctly.

#### Mechanics

<b>Mechanical design</b>	Solid shaft, face mount flange
--------------------------	--------------------------------

<sup>1)</sup> Relates to encoders with 2 m cable connection.

<sup>2)</sup> Higher values are possible using limited bearing life.

<sup>3)</sup> Allow for self-heating of 1.3 K per 1,000 rpm when designing the operating temperature range.

<sup>4)</sup> No permanent operation. Decreasing signal quality.

<b>Shaft diameter</b>	6 mm With flat
<b>Shaft length</b>	12 mm
<b>Weight</b>	Approx. 130 g <sup>1)</sup>
<b>Shaft material</b>	Stainless steel
<b>Flange material</b>	Aluminum
<b>Housing material</b>	Aluminum
<b>Material, cable</b>	PVC
<b>Start up torque</b>	0.3 Ncm
<b>Operating torque</b>	0.2 Ncm
<b>Permissible shaft loading</b>	40 N (radial) <sup>2)</sup> 20 N (axial)
<b>Operating speed</b>	6,000 min <sup>-1</sup> <sup>3)</sup>
<b>Maximum operating speed</b>	≤ 8,000 min <sup>-1</sup> <sup>4)</sup>
<b>Moment of inertia of the rotor</b>	7.6 gcm <sup>2</sup>
<b>Bearing lifetime</b>	2.0 x 10 <sup>9</sup> revolutions
<b>Angular acceleration</b>	≤ 500,000 rad/s <sup>2</sup>

<sup>1)</sup> Relates to encoders with 2 m cable connection.

<sup>2)</sup> Higher values are possible using limited bearing life.

<sup>3)</sup> Allow for self-heating of 1.3 K per 1,000 rpm when designing the operating temperature range.

<sup>4)</sup> No permanent operation. Decreasing signal quality.

#### Ambient data

<b>EMC</b>	According to EN 61000-6-2 and EN 61000-6-3
<b>Enclosure rating</b>	IP50
<b>Permissible relative humidity</b>	90 % (Condensation not permitted)
<b>Operating temperature range</b>	-10 °C ... +70 °C
<b>Storage temperature range</b>	-25 °C ... +85 °C
<b>Resistance to shocks</b>	100 g, 6 ms (EN 60068-2-27)
<b>Resistance to vibration</b>	20 g, 10 Hz ... 2,000 Hz (EN 60068-2-6)

#### Certificates

<b>EU declaration of conformity</b>	✓
<b>UK declaration of conformity</b>	✓
<b>ACMA declaration of conformity</b>	✓
<b>China RoHS</b>	✓
<b>Information according to Art. 3 of Data Act (Regulation EU 2023/2854)</b>	✓

#### Classifications

<b>ECLASS 5.0</b>	27270501
<b>ECLASS 5.1.4</b>	27270501
<b>ECLASS 6.0</b>	27270590
<b>ECLASS 6.2</b>	27270590
<b>ECLASS 7.0</b>	27270501

<b>ECLASS 8.0</b>	27270501
<b>ECLASS 8.1</b>	27270501
<b>ECLASS 9.0</b>	27270501
<b>ECLASS 10.0</b>	27270501
<b>ECLASS 11.0</b>	27270501
<b>ECLASS 12.0</b>	27270501
<b>ETIM 5.0</b>	EC001486
<b>ETIM 6.0</b>	EC001486
<b>ETIM 7.0</b>	EC001486
<b>ETIM 8.0</b>	EC001486
<b>UNSPSC 16.0901</b>	41112113

### Dimensional drawing Solid shaft

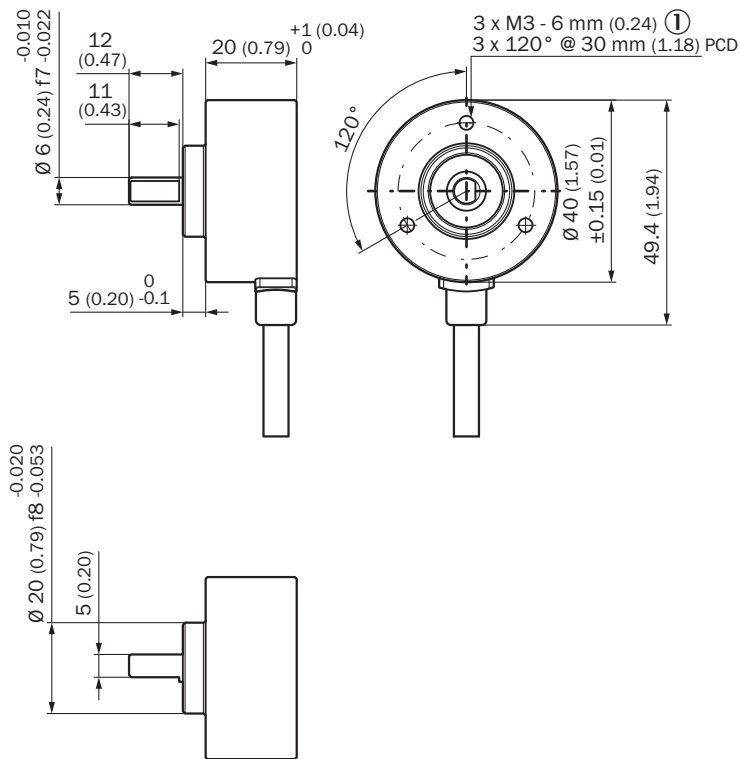

### Anschlussbelegung

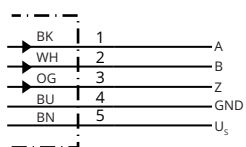

Wire colors (cable connection)	Signal	Description
Brown	U <sub>S</sub>	Supply voltage
Blue	GND	Ground connection
Black	A	Signal cable
White	B	Signal cable
Orange	Z	Signal cable



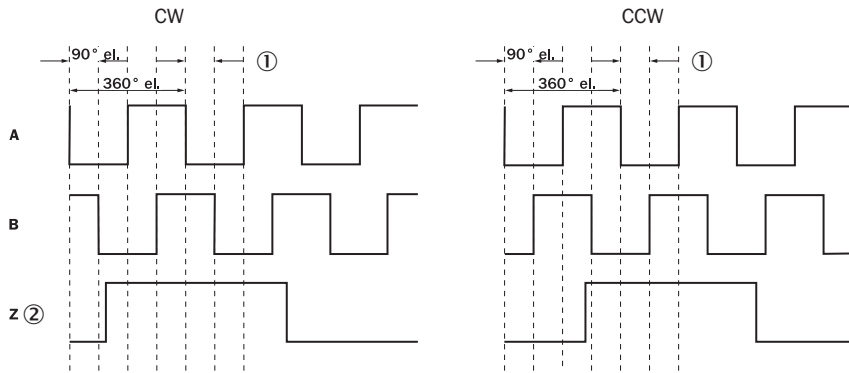





Diagrams HTL/Push-Pull











- ① Measuring step
- ② Only as reference

### Recommended accessories

Other models and accessories → [www.sick.com/DLS40](http://www.sick.com/DLS40)

	Brief description	Type	part no.
measuring wheels and measuring wheel mechanics			
	<ul style="list-style-type: none"> <li><b>Product segment:</b> Measuring wheels and measuring wheel mechanics</li> <li><b>Product:</b> Measuring wheels</li> <li><b>Description:</b> Aluminium measuring wheel with O-ring (NBR70) for 6 mm solid shaft, circumference 200 mm</li> </ul>	BEF-MR006020R	2055222
	<ul style="list-style-type: none"> <li><b>Product segment:</b> Measuring wheels and measuring wheel mechanics</li> <li><b>Product:</b> Measuring wheels</li> <li><b>Description:</b> Measuring wheel with O-ring (NBR70) for 6 mm solid shaft, circumference 300 mm</li> </ul>	BEF-MR006030R	2055634
	<ul style="list-style-type: none"> <li><b>Product segment:</b> Measuring wheels and measuring wheel mechanics</li> <li><b>Product:</b> Measuring wheels</li> <li><b>Description:</b> Aluminium measuring wheel with O-ring (NBR70) for 6 mm solid shaft, circumference 500 mm</li> </ul>	BEF-MR006050R	2055225
	<ul style="list-style-type: none"> <li><b>Product segment:</b> Measuring wheels and measuring wheel mechanics</li> <li><b>Product:</b> Measuring wheels</li> <li><b>Description:</b> Aluminum measuring wheel with cross-knurled surface for 6 mm solid shaft, circumference 200 mm</li> </ul>	BEF-MR06200AK	4084745
	<ul style="list-style-type: none"> <li><b>Product segment:</b> Measuring wheels and measuring wheel mechanics</li> <li><b>Product:</b> Measuring wheels</li> <li><b>Description:</b> Aluminum measuring wheel with smooth polyurethane surface for 6 mm solid shaft, circumference 200 mm</li> </ul>	BEF-MR06200AP	4084746
	<ul style="list-style-type: none"> <li><b>Product segment:</b> Measuring wheels and measuring wheel mechanics</li> <li><b>Product:</b> Measuring wheels</li> <li><b>Description:</b> Aluminum measuring wheel with ridged polyurethane surface for 6 mm solid shaft, circumference 200 mm</li> </ul>	BEF-MR06200APG	4084748
	<ul style="list-style-type: none"> <li><b>Product segment:</b> Measuring wheels and measuring wheel mechanics</li> <li><b>Product:</b> Measuring wheels</li> <li><b>Description:</b> Aluminum measuring wheel with studded polyurethane surface for 6 mm solid shaft, circumference 200 mm</li> </ul>	BEF-MR06200APN	4084747
	<ul style="list-style-type: none"> <li><b>Product segment:</b> Measuring wheels and measuring wheel mechanics</li> <li><b>Product:</b> Measuring wheel mechanics</li> </ul>	BEF-OR-053-040	2064061

	Brief description	Type	part no.
	<ul style="list-style-type: none"> <li><b>Description:</b> O-ring for measuring wheels (circumference 200 mm)</li> <li><b>Product segment:</b> Measuring wheels and measuring wheel mechanics</li> <li><b>Product:</b> Measuring wheel mechanics</li> <li><b>Description:</b> O-ring for measuring wheels (circumference 300 mm)</li> <li><b>Items supplied:</b> 2x O-ring</li> </ul>	BEF-OR-083-050	2064076
	<ul style="list-style-type: none"> <li><b>Product segment:</b> Measuring wheels and measuring wheel mechanics</li> <li><b>Product:</b> Measuring wheel mechanics</li> <li><b>Description:</b> O-ring for measuring wheels (circumference 500 mm)</li> </ul>	BEF-OR-145-050	2064074
shaft adaptation			
	<ul style="list-style-type: none"> <li><b>Product segment:</b> Shaft adaptation</li> <li><b>Product:</b> Shaft couplings</li> <li><b>Description:</b> Bellows coupling, shaft diameter 6 mm / 6 mm, maximum shaft offset: radial <math>\pm 0.25</math> mm, axial <math>\pm 0.4</math> mm, angular <math>\pm 4^\circ</math>; max. speed 10,000 rpm, <math>-30^\circ\text{C}</math> to <math>+120^\circ\text{C}</math>, max. torque 120 Ncm; material: stainless steel bellows, aluminum hub</li> </ul>	KUP-0606-B	5312981
	<ul style="list-style-type: none"> <li><b>Product segment:</b> Shaft adaptation</li> <li><b>Product:</b> Shaft couplings</li> <li><b>Description:</b> Cross-slotted coupling, shaft diameter 6 mm / 6 mm, maximum shaft offset: radial <math>\pm 0.3</math> mm, axial <math>\pm 0.2</math> mm, angle <math>\pm 3^\circ</math>; max. speed 10,000 rpm, <math>-10^\circ</math> to <math>+80^\circ\text{C}</math>, max. torque 80 Ncm; material: fiber-glass reinforced polyamide, aluminum hub</li> </ul>	KUP-0606-S	2056406
	<ul style="list-style-type: none"> <li><b>Product segment:</b> Shaft adaptation</li> <li><b>Product:</b> Shaft couplings</li> <li><b>Description:</b> Bar coupling, shaft diameter 6 mm / 8 mm, maximum shaft offset radial <math>\pm 0.3</math> mm, axial <math>\pm 0.2</math> mm, angle <math>\pm 3^\circ</math>, max. speed 10,000 rpm, torsion spring rigidity 38 Nm/wheel; material: fiber-glass reinforced polyamide, aluminum hub</li> </ul>	KUP-0608-S	5314179
	<ul style="list-style-type: none"> <li><b>Product segment:</b> Shaft adaptation</li> <li><b>Product:</b> Shaft couplings</li> <li><b>Description:</b> Bellows coupling, shaft diameter 6 mm / 10 mm, maximum shaft offset: radial <math>\pm 0.25</math> mm, axial <math>\pm 0.4</math> mm, angular <math>\pm 4^\circ</math>; max. speed 10,000 rpm, <math>-30^\circ\text{C}</math> to <math>+120^\circ\text{C}</math>, max. torque 120 Ncm; material: stainless steel bellows, aluminum hub</li> </ul>	KUP-0610-B	5312982
	<ul style="list-style-type: none"> <li><b>Product segment:</b> Shaft adaptation</li> <li><b>Product:</b> Shaft couplings</li> <li><b>Description:</b> Double loop coupling, shaft diameter 6 mm / 10 mm, max. shaft offset: radially <math>\pm 2.5</math> mm, axially <math>\pm 3</math> mm, angle <math>\pm 10</math> degrees; max. speed 3,000 rpm, <math>-30</math> to <math>+80</math> degrees Celsius, torsional spring stiffness of 25 Nm/rad</li> </ul>	KUP-0610-D	5326697
	<ul style="list-style-type: none"> <li><b>Product segment:</b> Shaft adaptation</li> <li><b>Product:</b> Shaft couplings</li> <li><b>Description:</b> Spring washer coupling, shaft diameter 6 mm / 10 mm, Maximum shaft offset: radial <math>\pm 0.3</math> mm, axial <math>\pm 0.4</math> mm, angular <math>\pm 2.5^\circ</math>; max. speed 12,000 rpm, <math>-10^\circ</math> to <math>+80^\circ\text{C}</math>, max. torque 60 Ncm; material: aluminum flange, glass fiber-reinforced polyamide membrane and hardened steel coupling pin</li> </ul>	KUP-0610-F	5312985
	<ul style="list-style-type: none"> <li><b>Product segment:</b> Shaft adaptation</li> <li><b>Product:</b> Shaft couplings</li> <li><b>Description:</b> Bar coupling, shaft diameter 6 mm / 10 mm, max. shaft offset: radial <math>\pm 0.3</math> mm, axial <math>\pm 0.3</math> mm, angular <math>\pm 3^\circ</math>; max. speed 10,000 rpm, <math>-10^\circ</math> to <math>+80^\circ\text{C}</math>, max. torque: 80 Ncm, material: fiber-glass reinforced polyamide, aluminum hub</li> </ul>	KUP-0610-S	2056407

## SICK AT A GLANCE

SICK is one of the leading manufacturers of intelligent sensors and sensor solutions for industrial applications. A unique range of products and services creates the perfect basis for controlling processes securely and efficiently, protecting individuals from accidents and preventing damage to the environment.

We have extensive experience in a wide range of industries and understand their processes and requirements. With intelligent sensors, we can deliver exactly what our customers need. In application centers in Europe, Asia and North America, system solutions are tested and optimized in accordance with customer specifications. All this makes us a reliable supplier and development partner.

Comprehensive services complete our offering: SICK LifeTime Services provide support throughout the machine life cycle and ensure safety and productivity.

For us, that is “Sensor Intelligence.”

## WORLDWIDE PRESENCE:

Contacts and other locations –[www.sick.com](http://www.sick.com)