



# HL18L-F4A5AE

H18 Sure Sense

PHOTOELECTRIC SENSORS

**SICK**  
Sensor Intelligence.



Illustration may differ



### Ordering information

| Type         | part no. |
|--------------|----------|
| HL18L-F4A5AE | 1121965  |

Other models and accessories → [www.sick.com/H18\\_Sure\\_Sense](http://www.sick.com/H18_Sure_Sense)

### Detailed technical data

#### Features

|  |   |
|--|---|
| <b>Functional principle</b>            | Photoelectric retro-reflective sensor                 |
| <b>Functional principle detail</b>     | With minimum distance to reflector (dual lens system) |
| <b>Dimensions (W x H x D)</b>          | 16.2 mm x 48.5 mm x 31.8 mm                           |
| <b>Housing design (light emission)</b> | Hybrid  |
| <b>Thread diameter (housing)</b>       | M18   |
| <b>Mounting system type</b>            | M18, head/side (24.1 ... 25.4 mm)                     |
| <b>Housing color</b>                   | Blue  |
| <b>Sensing range max.</b>              | 0.1 m ... 12 m <sup>1)</sup>                          |
| <b>Sensing range</b>                   | 0.1 m ... 10 m <sup>1)</sup>                          |
| <b>Type of light</b>                   | Visible red light                                     |
| <b>Light source</b>                    | Laser <sup>2)</sup><br><sup>3)</sup>                  |
| <b>Light spot size (distance)</b>      | 2 mm (2 m)  |
| <b>Wave length</b>                     | 655 nm  |
| <b>Laser class</b>                     | I <sup>4)</sup>                                       |
| <b>Adjustment</b>                      |   |
|  | Potentiometer, right Light/dark switching             |
|  | Potentiometer, left None                              |
| <b>Special applications</b>            | Detecting small objects                               |

<sup>1)</sup> Reflector PL80A.

<sup>2)</sup> Average service life: 50,000 h at T<sub>U</sub> = +25 °C.

<sup>3)</sup> CLASS 1 LASER PRODUCT EN60825-1:2014, IEC60825-1:2014, Maximum pulse power < 2.5 mW, Pulse length: 4 μs, Wavelength: 650 ... 670 nm, Complies with 21 CFR 1040.10 and 1040.11 except for deviations pursuant to Laser Notice No. 50, dated June 24, 2007.

<sup>4)</sup> Do not intentionally look into the laser beam. Never point the laser beam at people's eyes.

|                         |   |
|-------------------------|---|
| <b>Special features</b> | - |
|-------------------------|---|

1) Reflector PL80A.

2) Average service life: 50,000 h at  $T_{UJ} = +25\text{ °C}$ .

3) CLASS 1 LASER PRODUCT EN60825-1:2014, IEC60825-1:2014, Maximum pulse power < 2,5 mW, Pulse length: 4  $\mu$ s, Wavelength: 650 ... 670 nm, Complies with 21 CFR 1040.10 and 1040.11 except for deviations pursuant to Laser Notice No. 50, dated June 24, 2007.

4) Do not intentionally look into the laser beam. Never point the laser beam at people's eyes.

## Mechanics/electronics

|  |  |
|--|--|
| <b>Supply voltage</b>                      | 10 V DC ... 30 V DC  |
| <b>Ripple</b>                              | < 5 V <sub>pp</sub> <sup>1)</sup>  |
| <b>Current consumption</b>                 | ≤ 20 mA <sup>2)</sup>  |
| <b>Switching output</b>                    | Push-pull: PNP/NPN   |
| <b>Output function</b>                     | Complementary  |
| <b>Switching mode</b>                      | Light/dark switching   |
| <b>Switching output detail</b>             |  |
| Switching output Q1                        | Push-pull: PNP/NPN, Light switching <sup>3)</sup>  |
| Switching output Q2                        | Push-pull: PNP/NPN, Dark switching <sup>3)</sup>   |
| <b>Output current I<sub>max.</sub></b>     | ≤ 100 mA   |
| <b>Response time</b>                       | ≤ 0.5 ms <sup>4)</sup>   |
| <b>Switching frequency</b>                 | 1,000 Hz <sup>5)</sup>   |
| <b>Connection type</b>                     | Male connector M12, 4-pin  |
| <b>Cable material</b>                      | Plastic, PVC   |
| <b>Circuit protection</b>                  | A <sup>6)</sup><br>B <sup>7)</sup><br>D <sup>8)</sup>  |
| <b>Protection class</b>                    | III  |
| <b>Weight</b>                              | 18 g   |
| <b>Polarizing filter</b>                   | ✓  |
| <b>Housing material</b>                    | Plastic, VISTAL®   |
| <b>Optics material</b>                     | Plastic, PMMA  |
| <b>Enclosure rating</b>                    | IP67<br>IP69K  |
| <b>Items supplied</b>                      | Fastening nut (1x), M18, plastic, black, flat  |
| <b>Electromagnetic compatibility (EMC)</b> | EN 60947-5-2 (The sensor complies with the Radio Safety Requirements (EMC) for the industrial sector (Radio Safety Class A). It may cause radio interference if used in a residential area.) |
| <b>Ambient operating temperature</b>       | -30 °C ... +55 °C <sup>9)</sup>  |

1) May not fall below or exceed U<sub>y</sub> tolerances.

2) Without signal strength light bar and load.

3) Pin 4 and pin 2: This switching output must not be connected to another output.

4) Signal transit time with resistive load.

5) With light/dark ratio 1:1.

6) A = V<sub>S</sub> connections reverse-polarity protected.

7) B = inputs and output reverse-polarity protected.

8) D = outputs overcurrent and short-circuit protected.

9) Below Ta = -10 °C, sensor must be turned on at Ta > -10 °C. Sensor cannot be turned on below Ta = -10 °C.

|                                     |                   |
|-------------------------------------|-------------------|
| <b>Ambient temperature, storage</b> | -40 °C ... +70 °C |
| <b>UL File No.</b>                  | E189383           |

- 1) May not fall below or exceed  $U_V$  tolerances.
- 2) Without signal strength light bar and load.
- 3) Pin 4 and pin 2: This switching output must not be connected to another output.
- 4) Signal transit time with resistive load.
- 5) With light/dark ratio 1:1.
- 6) A =  $V_S$  connections reverse-polarity protected.
- 7) B = inputs and output reverse-polarity protected.
- 8) D = outputs overcurrent and short-circuit protected.
- 9) Below  $T_a = -10$  °C, sensor must be turned on at  $T_a > -10$  °C. Sensor cannot be turned on below  $T_a = -10$  °C.

### Connection type/pinouts

|                               |                |                           |
|-------------------------------|----------------|---------------------------|
| <b>Connection type</b>        |                | Male connector M12, 4-pin |
| <b>Connection type Detail</b> |                |                           |
|                               | Cable material | Plastic                   |
| <b>Pinouts</b>                |                |                           |
|                               | BN 1           | + (L+)                    |
|                               | WH 2           | Q <sub>2</sub>            |
|                               | BU 3           | - (M)                     |
|                               | BK 4           | Q <sub>1</sub>            |

### Certificates

|   |   |
|---|---|
| <b>EU declaration of conformity</b>       | ✓ |
| <b>UK declaration of conformity</b>       | ✓ |
| <b>ACMA declaration of conformity</b>     | ✓ |
| <b>Moroccan declaration of conformity</b> | ✓ |
| <b>China RoHS</b>                         | ✓ |
| <b>cULus certificate</b>                  | ✓ |

### Classifications

|                     |          |
|---------------------|----------|
| <b>ECLASS 5.0</b>   | 27270902 |
| <b>ECLASS 5.1.4</b> | 27270902 |
| <b>ECLASS 6.0</b>   | 27270902 |
| <b>ECLASS 6.2</b>   | 27270902 |
| <b>ECLASS 7.0</b>   | 27270902 |
| <b>ECLASS 8.0</b>   | 27270902 |
| <b>ECLASS 8.1</b>   | 27270902 |
| <b>ECLASS 9.0</b>   | 27270902 |
| <b>ECLASS 10.0</b>  | 27270902 |
| <b>ECLASS 11.0</b>  | 27270902 |
| <b>ECLASS 12.0</b>  | 27270902 |
| <b>ETIM 5.0</b>     | EC002717 |
| <b>ETIM 6.0</b>     | EC002717 |
| <b>ETIM 7.0</b>     | EC002717 |

|                       |          |
|-----------------------|----------|
| <b>ETIM 8.0</b>       | EC002717 |
| <b>UNSPSC 16.0901</b> | 39121528 |

### Dimensional drawing

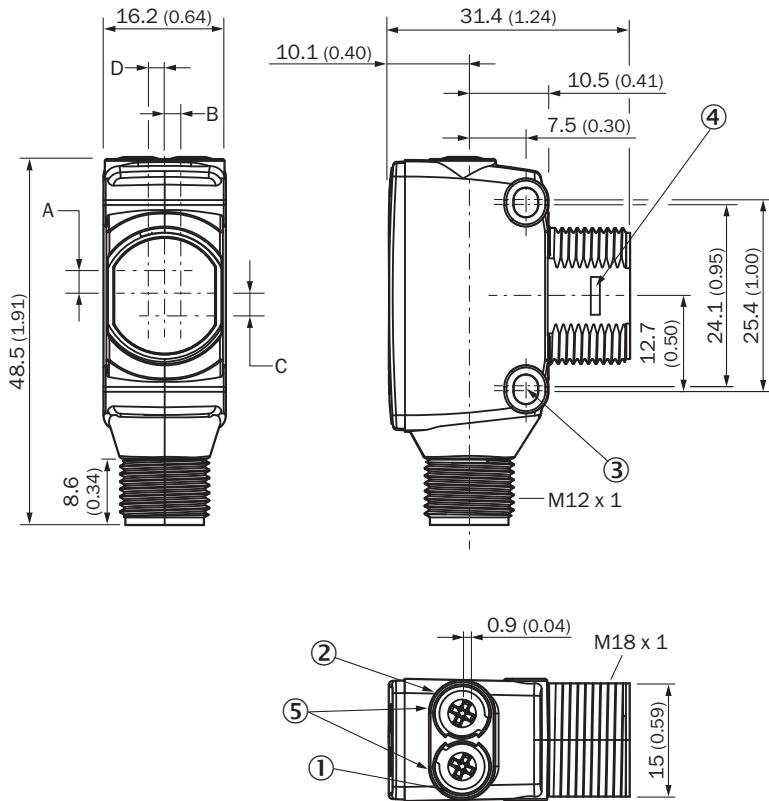

Dimensions in mm (inch)

- ① LED indicator yellow: Status of received light beam
- ② LED indicator green: power on
- ③ M3 mounting hole
- ④ Snap Connection for flush ring (sold separately)
- ⑤ Potentiometer (if selected) or LED Indicators

| Dimensions in mm (inch)                 | Receiver     |            | Sender     |            |
|---|--------------|------------|------------|------------|
|   | A            | B          | C          | D          |
| -                                       | A            | B          | C          | D          |
| <b>HTB18 / HTF18</b>                    | - 1.1 (0.04) | 1.1 (0.04) | 4.7 (0.19) | 0.6 (0.02) |
| <b>HTE18 / HL18 / HSE18</b>             | 2.5 (0.1)    | 0.0 (0.0)  | 4.0 (0.16) | 0.0 (0.0)  |
| <b>HTB18L / HTF18L / HL18L / HSE18L</b> | 2.5 (0.1)    | 0.0 (0.0)  | 3.5 (0.14) | 0.0 (0.0)  |

Pinouts, see table [Technical data: Connection type/pinouts](#)

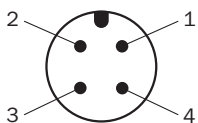

M12 male connector, 4-pin, A-coding

### Characteristic curve

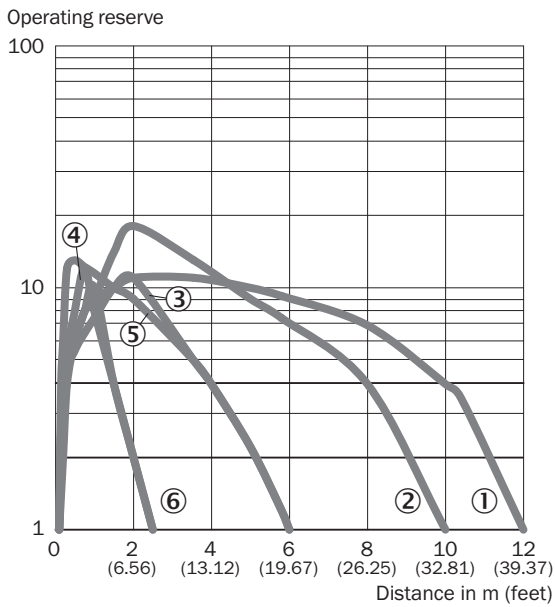

- ① Reflector PL80A
- ② Reflector P250F
- ③ PL10F reflector
- ④ Reflector PL23 FT
- ⑤ Reflective tape REF-AC1000
- ⑥ Reflective tape IREF6000 (REF-IRF-56)

### Light spot size

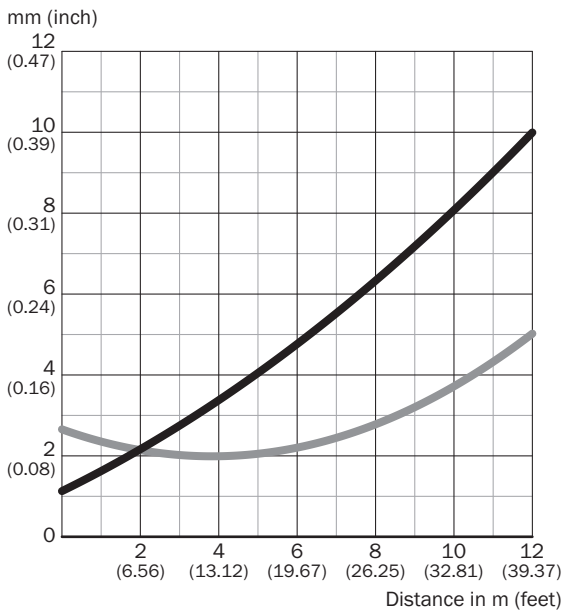

#### Dimensions in mm (inch)

| Sensing range                       | Vertical       | Horizontal     |
|-------------------------------------|----------------|----------------|
| <b>0.2 m</b><br><b>(0.57 feet)</b>  | 1.2<br>(0.05)  | 2.65<br>(0.10) |
| <b>0.75 m</b><br><b>(2.46 feet)</b> | 1.8<br>(0.07)  | 2.3<br>(0.09)  |
| <b>5 m</b><br><b>(16.40 feet)</b>   | 4.0<br>(0.16)  | 2.2<br>(0.09)  |
| <b>12 m</b><br><b>(39.37 feet)</b>  | 10.0<br>(0.39) | 5.0<br>(0.20)  |

- Vertical
- Horizontal

Sensing range diagram

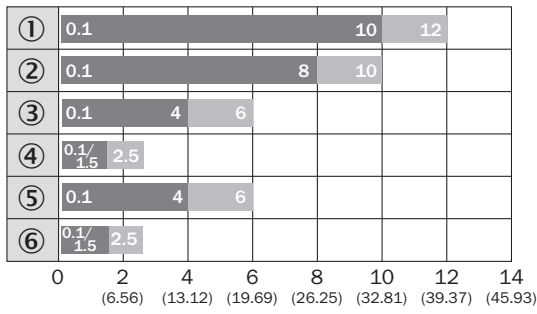

Distance in m (feet)

■ Sensing range      ■ Sensing range max.





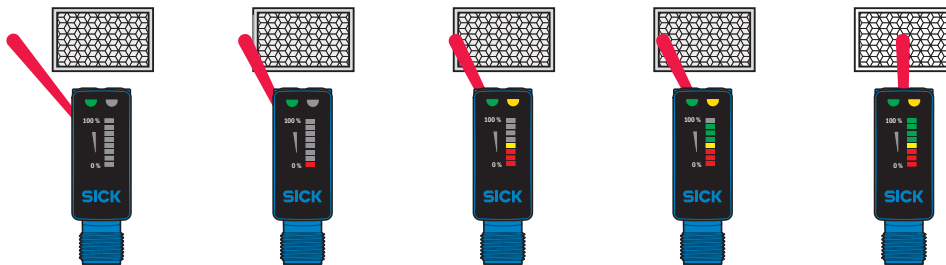

- ① Reflector PL80A
- ② Reflector P250F
- ③ PL10F reflector
- ④ Reflector PL23 FT
- ⑤ Reflective tape REF-AC1000
- ⑥ Reflective tape IREF6000 (REF-IRF-56)

Functions



### Recommended accessories

Other models and accessories → [www.sick.com/H18\\_Sure\\_Sense](http://www.sick.com/H18_Sure_Sense)

|   | Brief description  | Type               | part no. |
|---|--|--------------------|----------|
| <b>Mounting systems</b>   |  |                    |          |
|    | <ul style="list-style-type: none"> <li><b>Description:</b> Mounting bracket for M18 sensors</li> <li><b>Material:</b> Steel</li> <li><b>Details:</b> Steel, zinc coated</li> <li><b>Items supplied:</b> Without mounting hardware</li> <li><b>Suitable for:</b> GR18, V180-2, V18, W15, Z1, Z2</li> </ul>  | BEF-WN-M18         | 5308446  |
|    | <ul style="list-style-type: none"> <li><b>Description:</b> Universal mounting bracket for reflectors</li> <li><b>Dimensions (W x H x L):</b> 85 mm x 90 mm x 35 mm</li> <li><b>Material:</b> Steel</li> <li><b>Details:</b> Steel, zinc coated</li> <li><b>Suitable for:</b> C110A, P250, PL20, PL30A, PL40A, PL80A</li> </ul>   | BEF-WN-REFX        | 2064574  |
|    | <ul style="list-style-type: none"> <li><b>Description:</b> Plate N11N for universal clamp bracket</li> <li><b>Material:</b> Stainless steel</li> <li><b>Details:</b> Stainless steel 1.4571 (sheet), Stainless steel 1.4408 (clamp)</li> <li><b>Items supplied:</b> Universal clamp (5322627), mounting hardware</li> <li><b>Usable for:</b> DeltaPac, Glare, WTD20E</li> </ul>  | BEF-KHS-N11N       | 2071081  |
| <b>reflectors and optics</b>  |  |                    |          |
|    | <ul style="list-style-type: none"> <li><b>Description:</b> Fine triple reflector, screw connection, suitable for laser sensors</li> <li><b>Dimensions:</b> 52 mm 62 mm</li> <li><b>Ambient operating temperature:</b> -30 °C ... +65 °C</li> </ul>   | P250F              | 5308843  |
| <b>connectors and cables</b>  |  |                    |          |
|  | <ul style="list-style-type: none"> <li><b>Connection type head A:</b> Female connector, M12, 4-pin, straight, A-coded</li> <li><b>Connection type head B:</b> Flying leads</li> <li><b>Signal type:</b> Sensor/actuator cable</li> <li><b>Cable:</b> 5 m, 4-wire, PVC</li> <li><b>Description:</b> Sensor/actuator cable, unshielded</li> <li><b>Application:</b> Uncontaminated zones, Zones with chemicals</li> </ul>  | YF2A14-050VB3XLEAX | 2096235  |
|  | <ul style="list-style-type: none"> <li><b>Description:</b> Unshielded</li> <li><b>Connection type head A:</b> Male connector, M12, 4-pin, straight, A-coded</li> <li><b>Connection systems:</b> Screw-type terminals</li> <li><b>Permitted cross-section:</b> ≤ 0.75 mm<sup>2</sup></li> </ul>   | STE-1204-G         | 6009932  |
|  | <ul style="list-style-type: none"> <li><b>Connection type head A:</b> Female connector, M12, 4-pin, straight, A-coded</li> <li><b>Connection type head B:</b> Flying leads</li> <li><b>Signal type:</b> Sensor/actuator cable</li> <li><b>Cable:</b> 5 m, 4-wire, PUR, halogen-free</li> <li><b>Description:</b> Sensor/actuator cable, unshielded</li> <li><b>Application:</b> Drag chain operation, Zones with oils and lubricants, Robot, Drag chain operation</li> </ul> | YF2A14-050UB3XLEAX | 2095608  |

## SICK AT A GLANCE

SICK is one of the leading manufacturers of intelligent sensors and sensor solutions for industrial applications. A unique range of products and services creates the perfect basis for controlling processes securely and efficiently, protecting individuals from accidents and preventing damage to the environment.

We have extensive experience in a wide range of industries and understand their processes and requirements. With intelligent sensors, we can deliver exactly what our customers need. In application centers in Europe, Asia and North America, system solutions are tested and optimized in accordance with customer specifications. All this makes us a reliable supplier and development partner.

Comprehensive services complete our offering: SICK LifeTime Services provide support throughout the machine life cycle and ensure safety and productivity.

For us, that is “Sensor Intelligence.”

## WORLDWIDE PRESENCE:

Contacts and other locations –[www.sick.com](http://www.sick.com)