



WTB4FI-32162120A00

W4

PHOTOELECTRIC SENSORS

SICK
Sensor Intelligence.



Illustration may differ

Ordering information

Type	part no.
WTB4FI-32162120A00	1120895

Other models and accessories → www.sick.com/W4



Detailed technical data

Features

Functional principle	Photoelectric proximity sensor
Functional principle detail	Background suppression
Sensing range	
Sensing range min.	6 mm
Sensing range max.	250 mm
Adjustable switching threshold for background suppression	15 mm ... 250 mm
Reference object	Object with 90% remission factor (complies with standard white according to DIN 5033)
Minimum distance between set sensing range and background (black 6% / white 90%)	4 mm, at a distance of 100 mm
Recommended sensing range for the best performance	40 mm ... 160 mm
Emitted beam	
Light source	PinPoint LED
Type of light	Infrared light
Shape of light spot	Point-shaped
Light spot size (distance)	Ø 4.2 mm (130 mm)
Maximum dispersion of the emitted beam around the standardized transmission axis (squint angle)	< +/- 1.5° (at T _U = +23 °C)
Key LED figures	

Normative reference	EN 62471:2008-09 IEC 62471:2006, modified
LED risk group marking	Free group
Wave length	635 nm
Average service life	100,000 h at $T_a = +25 \text{ }^\circ\text{C}$
Smallest detectable object (MDO) typ.	
	0.2 mm, At 130 mm distance (object with remission factor of 90% (complies with standard white according to DIN 5033))
Adjustment	
Teach-Turn adjustment	BluePilot For setting the sensing range
IO-Link	For configuring the sensor parameters and Smart Task functions
Display	
LED blue	BluePilot: sensing range indicator
LED green	Operating indicator Static on: power on Flashing: IO-Link mode
LED yellow	Status of received light beam Static on: object present Static off: object not present

Safety-related parameters

MTTF_D	642 years
DC_{avg}	0 %
T_M (mission time)	20 years

Communication interface

IO-Link	✓, IO-Link V1.1
Data transmission rate	COM2 (38,4 kBaud)
Cycle time	2.3 ms
Process data length	16 Bit
Process data structure	Bit 0 = switching signal Q _{L1} Bit 1 = switching signal Q _{L2} Bit 2 ... 15 = Current receiver level (live)
VendorID	26
DeviceID HEX	0x8002BD
DeviceID DEC	8389309
Compatible master port type	A
SIO mode support	Yes

Electronics

Supply voltage U_B	10 V DC ... 30 V DC ¹⁾
Ripple	≤ 5 V _{pp}
Usage category	DC-12 (According to EN 60947-5-2)

¹⁾ Limit values.

²⁾ Signal transit time with resistive load in switching mode.

³⁾ With light/dark ratio 1:1.

⁴⁾ This switching output must not be connected to another output.

	DC-13 (According to EN 60947-5-2)
Current consumption	≤ 25 mA, without load. At $U_B = 24\text{ V}$
Protection class	III
Digital output	
Number	2 (Complementary)
Type	Push-pull: PNP/NPN
Switching mode	Light/dark switching
Signal voltage PNP HIGH/LOW	Approx. $U_B - 2.5\text{ V} / 0\text{ V}$
Signal voltage NPN HIGH/LOW	Approx. $U_B / < 2.5\text{ V}$
Output current $I_{max.}$	≤ 100 mA
Circuit protection outputs	Reverse polarity protected
	Overcurrent protected
	Short-circuit protected
Response time	≤ 500 μs ²⁾
Repeatability (response time)	150 μs
Switching frequency	1,000 Hz ³⁾
Pin/Wire assignment	
Function of pin 4/black (BK)	Digital output, dark switching, object present → output \bar{Q}_{L1} LOW; IO-Link communication C ⁴⁾
Function of pin 4/black (BK) – detail	The pin 4 function of the sensor can be configured
	Additional possible settings via IO-Link
Function of pin 2/white (WH)	Digital output, light switching, object present → output Q_{L1} HIGH ⁴⁾
Function of pin 2/white (WH) – detail	The pin 2 function of the sensor can be configured
	Additional possible settings via IO-Link

¹⁾ Limit values.

²⁾ Signal transit time with resistive load in switching mode.

³⁾ With light/dark ratio 1:1.

⁴⁾ This switching output must not be connected to another output.

Mechanics

Housing	Rectangular
Design detail	Flat
Dimensions (W x H x D)	16 mm x 40.1 mm x 12.1 mm
Connection	Cable with M8 male connector, 4-pin, 110 mm
Connection detail	
Deep-freeze property	Do not bend below 0 °C
Conductor size	0.14 mm ²
Cable diameter	∅ 3.4 mm
Length of cable (L)	77 mm
Material	
Housing	Plastic, VISTAL®
Front screen	Plastic, PMMA
Cable	Plastic, PVC
Male connector	Plastic, VISTAL®

Weight	Approx. 30 g
Maximum tightening torque of the fixing screws	0.4 Nm

Ambient data

Enclosure rating	IP66 (EN 60529) IP67 (EN 60529)
Ambient operating temperature	-40 °C ... +60 °C
Ambient temperature, storage	-40 °C ... +75 °C
Typ. Ambient light immunity	Artificial light: ≤ 50,000 lx Sunlight: ≤ 50,000 lx
Shock resistance	30 g, 11 ms (3 positive and 3 negative shocks along X, Y, Z axes, 18 total shocks (EN60068-2-27))
Vibration resistance	10 Hz ... 1,000 Hz (Amplitude 1 mm, 3 x 30 min (EN60068-2-6))
Air humidity	35 % ... 95 %, relative humidity (no condensation)
Electromagnetic compatibility (EMC)	EN 60947-5-2
Resistance to cleaning agent	ECOLAB
UL File No.	NRKH.E181493 & NRKH7.E181493

Smart Task

Smart Task name	Base logics
Logic function	Direct AND OR
Timer function	Deactivated Switch-on delay Off delay ON and OFF delay Impulse (one shot)
Inverter	Yes
Switching frequency	SIO Logic: 900 Hz ¹⁾ IOL: 800 Hz ²⁾
Response time	SIO Logic: 550 μs ¹⁾ IOL: 600 μs ²⁾
Repeatability	SIO Logic: 200 μs ¹⁾ IOL: 250 μs ²⁾
Switching signal	
Switching signal Q _{L1}	Switching output
Switching signal \bar{Q}_{L1}	Switching output

¹⁾ Use of Smart Task functions without IO-Link communication (SIO mode).

²⁾ Use of Smart Task functions with IO-Link communication function.

Diagnosis

Device temperature	
Measuring range	Very cold, cold, moderate, warm, hot
Device status	Yes
Detailed device status	Yes
Operating hour counter	Yes

Operating hours counter with reset function	Yes
Quality of teach	Yes

Certificates

EU declaration of conformity	✓
UK declaration of conformity	✓
ACMA declaration of conformity	✓
Moroccan declaration of conformity	✓
China RoHS	✓
ECOLAB certificate	✓
cULus certificate	✓
IO-Link certificate	✓
Information according to Art. 3 of Data Act (Regulation EU 2023/2854)	✓

Classifications

ECLASS 5.0	27270904
ECLASS 5.1.4	27270904
ECLASS 6.0	27270904
ECLASS 6.2	27270904
ECLASS 7.0	27270904
ECLASS 8.0	27270904
ECLASS 8.1	27270904
ECLASS 9.0	27270904
ECLASS 10.0	27270904
ECLASS 11.0	27270904
ECLASS 12.0	27270903
ETIM 5.0	EC002719
ETIM 6.0	EC002719
ETIM 7.0	EC002719
ETIM 8.0	EC002719
UNSPSC 16.0901	39121528

display and adjustment elements

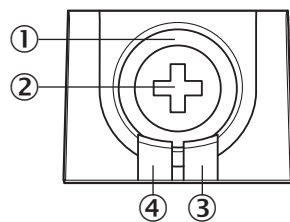

- ① LED blue
- ② Teach-Turn adjustment

- ③ LED yellow
- ④ LED green

Connection type Male connector M8, 4-pin

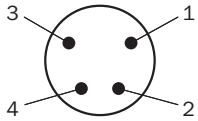

Connection diagram Cd-503

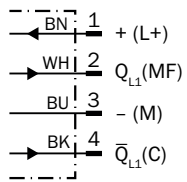

Truth table Push-pull: PNP/NPN – dark switching \bar{Q}

	Dark switching \bar{Q} (normally closed (upper switch), normally open (lower switch))	
	Object not present → Output HIGH	Object present → Output LOW
Light receive	✗	✔
Light receive indicator	✗	☀
Load resistance to L+	✗	⚡
Load resistance to M	⚡	✗
	<p>Diagram showing the sensor's output terminal connected to L+ through a normally closed switch (\bar{Q}). The other terminal of the switch is connected to M. This configuration results in a HIGH output when no object is present.</p>	<p>Diagram showing the sensor's output terminal connected to L+ through a normally open switch (\bar{Q}). The other terminal of the switch is connected to M. An object is present, blocking the sensor's light path. This configuration results in a LOW output when an object is present.</p>

Truth table Push-pull: PNP/NPN - light switching Q

	Light switching Q (normally open (upper switch), normally closed (lower switch))	
	Object not present → Output LOW	Object present → Output HIGH
Light receive	✗	✓
Light receive indicator	✗	☀
Load resistance to L+	⚡	✗
Load resistance to M	✗	⚡

Characteristic curve

Minimum distance in mm (y) between the set sensing range and white background (90 % remission)

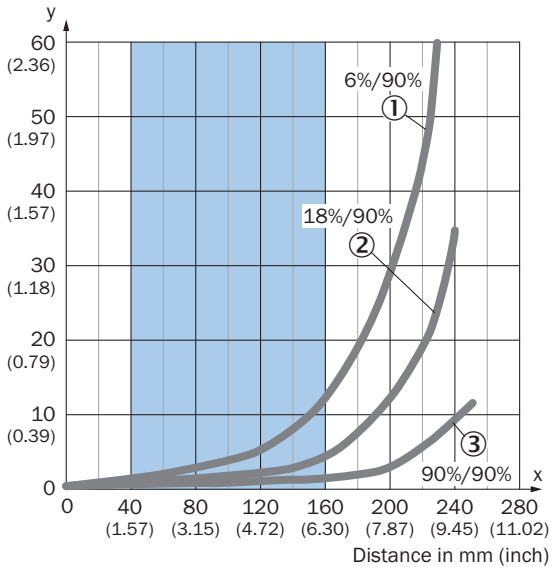

Recommended sensing range for the best performance

- ① Black object, 6% remission factor
- ② Gray object, 18% remission factor
- ③ White object, 90% remission factor

Example:
Safe suppression of the background

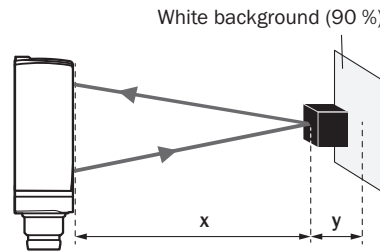

Black object (6 % remission)
Set sensing range $x = 200$ mm
Needed minimum distance to white background $y = 29$ mm

Light spot size

Dimensions in mm (inch)

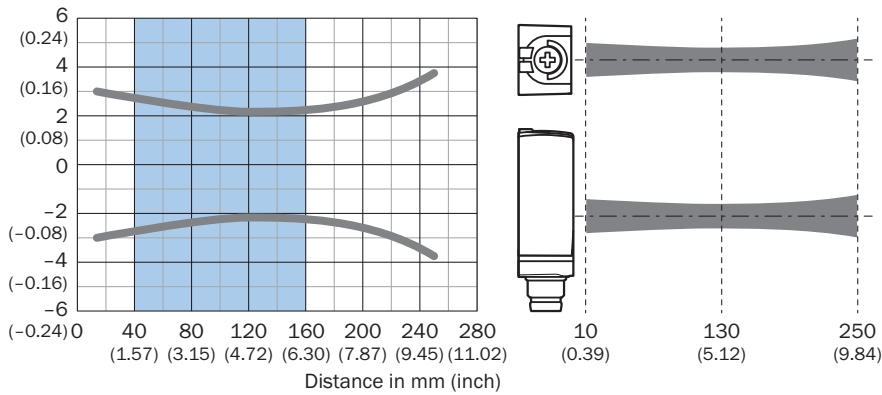

Recommended sensing range for the best performance

Sensing range diagram

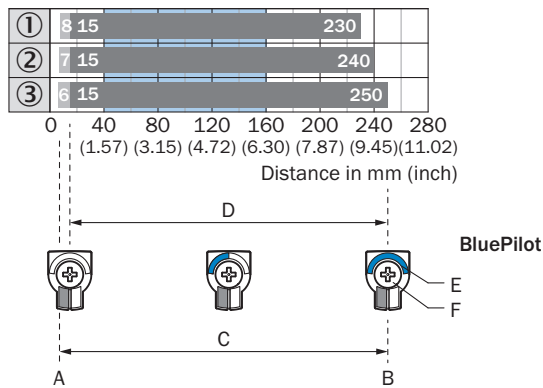

- A = Sensing range min. in mm
- B = Sensing range max. in mm
- C = Viewing range
- D = Adjustable switching threshold for background suppression
- E = Sensing range indicator
- F = Teach-Turn adjustment

Recommended sensing range for the best performance

- ① Black object, 6% remission factor
- ② Gray object, 18% remission factor
- ③ White object, 90% remission factor

Dimensional drawing

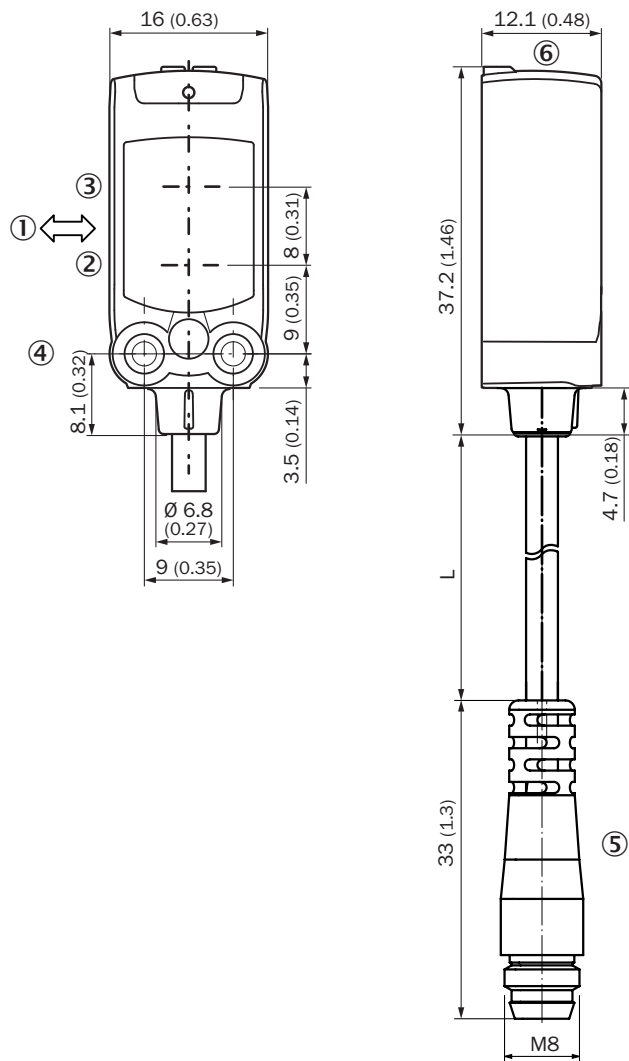

Dimensions in mm (inch)

For length of cable (L), see technical data

- ① Standard direction of the material being detected
- ② Center of optical axis, sender
- ③ Center of optical axis, receiver
- ④ M3 mounting hole
- ⑤ cable with connector M8
- ⑥ display and adjustment elements

Recommended accessories

Other models and accessories → www.sick.com/W4

	Brief description	Type	part no.
Mounting systems			
	<ul style="list-style-type: none"> Description: Mounting bracket for wall mounting Material: Stainless steel Details: Stainless steel 1.4571 Items supplied: Mounting hardware included Suitable for: W4S, W4F, W4S 	BEF-W4-A	2051628
	<ul style="list-style-type: none"> Description: Mounting bracket for floor mounting Material: Stainless steel Details: Stainless steel 1.4571 Items supplied: Mounting hardware included Suitable for: W4S, W4F, W4S 	BEF-W4-B	2051630
	<ul style="list-style-type: none"> Description: Plate N08 for universal clamp bracket Material: Steel, zinc diecast Details: Zinc plated steel (sheet), Zinc die cast (clamping bracket) Items supplied: Universal clamp (5322626), mounting hardware Usable for: W100, W150, W4S, W4F, W8, W9-3, W8G, W8 Laser, W8 Inox, G6, W100 Laser, W100-2, W10, G6 Inox, RAY10, W4SLG-3, W9, GR18, MultiPulse, Reflex Array, MultiLine, LUT3, KT5, KT8, KT10, CS8 	BEF-KHS-N08	2051607
connectors and cables			
	<ul style="list-style-type: none"> Description: Unshielded Connection type head A: Male connector, M8, 4-pin, straight, A-coded Connection systems: Screw-type terminals Permitted cross-section: 0.14 mm² ... 0.5 mm² 	STE-0804-G	6037323
	<ul style="list-style-type: none"> Description: Sensor/actuator cable, unshielded Connection type head A: Female connector, M8, 4-pin, straight, A-coded Connection type head B: Flying leads Signal type: Sensor/actuator cable Cable: 5 m, 4-wire, PUR, halogen-free Application: Drag chain operation, Zones with oils and lubricants, Robot, Drag chain operation 	YF8U14-050UA3XLEAX	2094792
	<ul style="list-style-type: none"> Description: Sensor/actuator cable, unshielded Connection type head A: Female connector, M8, 4-pin, straight, A-coded Connection type head B: Flying leads Signal type: Sensor/actuator cable Cable: 5 m, 4-wire, PVC Application: Uncontaminated zones, Zones with chemicals 	YF8U14-050VA3XLEAX	2095889

SICK AT A GLANCE

SICK is one of the leading manufacturers of intelligent sensors and sensor solutions for industrial applications. A unique range of products and services creates the perfect basis for controlling processes securely and efficiently, protecting individuals from accidents and preventing damage to the environment.

We have extensive experience in a wide range of industries and understand their processes and requirements. With intelligent sensors, we can deliver exactly what our customers need. In application centers in Europe, Asia and North America, system solutions are tested and optimized in accordance with customer specifications. All this makes us a reliable supplier and development partner.

Comprehensive services complete our offering: SICK LifeTime Services provide support throughout the machine life cycle and ensure safety and productivity.

For us, that is “Sensor Intelligence.”

WORLDWIDE PRESENCE:

Contacts and other locations –www.sick.com