

# DGS80B-TSLA04096

DGS80/90

INCREMENTAL ENCODERS

**SICK**  
Sensor Intelligence.

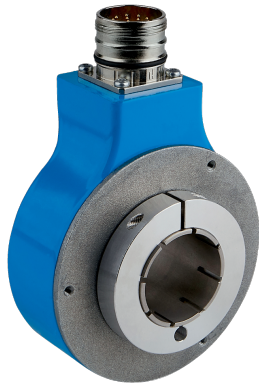

Illustration may differ



### Ordering information

Type	part no.
DGS80B-TSLA04096	1118699

Other models and accessories → [www.sick.com/DGS80\\_90](http://www.sick.com/DGS80_90)

### Detailed technical data

#### Safety-related parameters

<b>MTTF<sub>D</sub> (mean time to dangerous failure)</b>	518 years (EN ISO 13849-1) <sup>1)</sup>
--	--

<sup>1)</sup> This product is a standard product and does not constitute a safety component as defined in the Machinery Directive. Calculation based on nominal load of components, average ambient temperature 40°C, frequency of use 8760 h/a. All electronic failures are considered hazardous. For more information, see document no. 8015532.

#### Performance

<b>Pulses per revolution</b>	4,096
<b>Measuring step</b>	90°, electric/pulses per revolution
<b>Measuring step deviation</b>	± 15° electrical
<b>Duty cycle</b>	≤ 0.5 ± 15 %

#### Interfaces

<b>Communication interface</b>	Incremental
<b>Communication Interface detail</b>	HTL / Push pull
<b>Number of signal channels</b>	6-channel
<b>Initialization time</b>	< 50 ms
<b>Output frequency</b>	≤ 300 kHz
<b>Load current</b>	≤ 40 mA, per channel
<b>Operating current</b>	≤ 50 mA (without load)
<b>Power consumption</b>	≤ 0.85 W

#### Electronics

<b>Connection type</b>	Male connector, M23, 12-pin, radial
<b>Supply voltage</b>	5 ... 30 V
<b>Reference signal, position</b>	90°, electric, logically gated with A and B
<b>Reverse polarity protection</b>	✓

<b>Short-circuit protection of the outputs</b>	✓
--	---

## Mechanics

<b>Mechanical design</b>	Through hollow shaft
<b>Shaft diameter</b>	30 mm Front clamp <sup>1)</sup>
<b>Flange type / stator coupling</b>	1-sided stator coupling with slot available for order as accessory
<b>Weight</b>	650 g
<b>Shaft material</b>	Aluminum
<b>Flange material</b>	ZAMAC die cast
<b>Housing material</b>	ZAMAC die cast
<b>Shaft sealing ring material</b>	FKM70
<b>Start up torque</b>	6 Ncm (+20 °C)
<b>Operating torque</b>	5 Ncm (+20 °C)
<b>Permissible shaft loading</b>	100 N (radial) 100 N (axial)
<b>Operating speed</b>	≤ 3,600 min <sup>-1</sup>
<b>Moment of inertia of the rotor</b>	408 gcm <sup>2</sup>
<b>Bearing lifetime</b>	10 <sup>9</sup> revolutions

<sup>1)</sup> Collets (shaft reducer) available as accessories to reduce shaft sizes under 30 mm / 42 mm.

## Ambient data

<b>EMC</b>	According to EN 61000-6-2 and EN 61000-6-3
<b>Enclosure rating</b>	IP65 (IEC 60529)
<b>Permissible relative humidity</b>	98 % (Condensation not permitted)
<b>Operating temperature range</b>	-25 °C ... +85 °C
<b>Storage temperature range</b>	-25 °C ... +85 °C, without package
<b>Resistance to shocks</b>	250 g, 6 ms (EN 60068-2-27)
<b>Resistance to vibration</b>	10 g, 5 Hz ... 2,000 Hz (EN 60068-2-6)

## Certificates

<b>EU declaration of conformity</b>	✓
<b>UK declaration of conformity</b>	✓
<b>ACMA declaration of conformity</b>	✓
<b>China RoHS</b>	✓
<b>cRUus certificate</b>	✓
<b>Information according to Art. 3 of Data Act (Regulation EU 2023/2854)</b>	✓

## Classifications

<b>ECLASS 5.0</b>	27270501
<b>ECLASS 5.1.4</b>	27270501
<b>ECLASS 6.0</b>	27270590
<b>ECLASS 6.2</b>	27270590
<b>ECLASS 7.0</b>	27270501

<b>ECLASS 8.0</b>	27270501
<b>ECLASS 8.1</b>	27270501
<b>ECLASS 9.0</b>	27270501
<b>ECLASS 10.0</b>	27270501
<b>ECLASS 11.0</b>	27270501
<b>ECLASS 12.0</b>	27270501
<b>ETIM 5.0</b>	EC001486
<b>ETIM 6.0</b>	EC001486
<b>ETIM 7.0</b>	EC001486
<b>ETIM 8.0</b>	EC001486
<b>UNSPSC 16.0901</b>	41112113

### Dimensional drawing Bore hole size 30 mm, M23 male connector

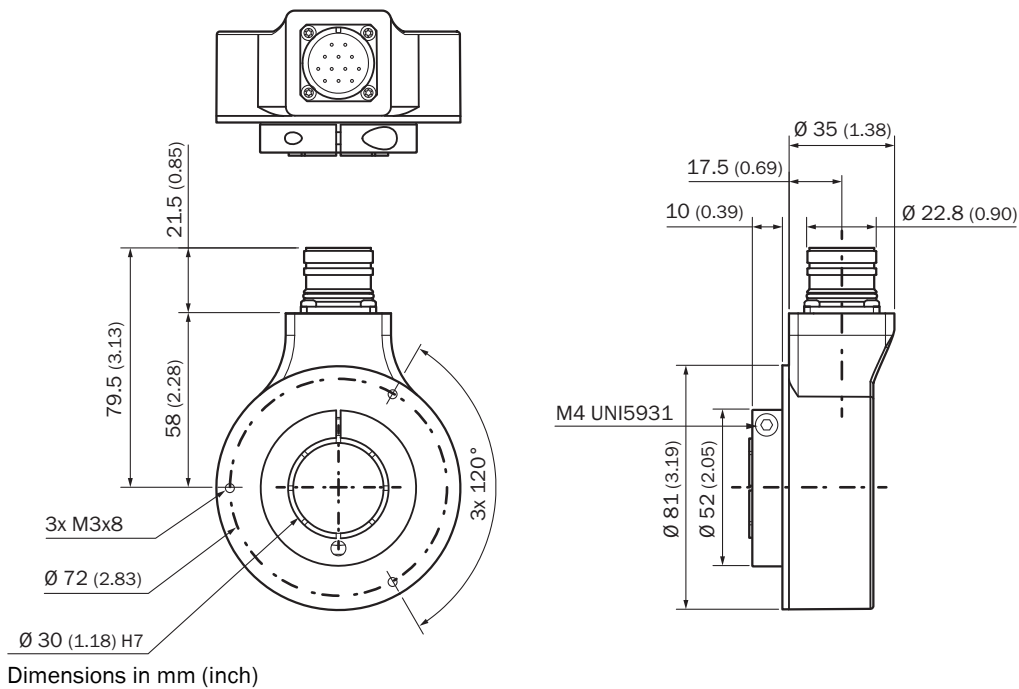

### Anschlussbelegung

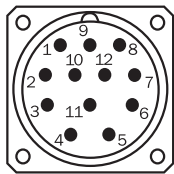



Wire colors (cable connection)	PINMale connector M12, 8-pin	PINMale connector M23, 12-pin	PINMS male connector, 10-pin	Signal	Explanation
Brown	1	6	H	A-	Signal cable

Wire colors (cable connection)	PINMale connector M12, 8-pin	PINMale connector M23, 12-pin	PINMS male connector, 10-pin	Signal	Explanation
White	2	5	A	A	Signal cable
Black	3	1	I	B-	Signal cable
Pink	4	8	B	B	Signal cable
Yellow	5	4	J	Z-	Signal cable
Purple	6	3	C	Z	Signal cable
Blue	7	10	F	GND	Ground connection
Red	8	12	D	+U <sub>S</sub>	Supply voltage
-	-	2	E	N.c.	Not connected
-	-	7	-	N.c.	Not connected
-	-	-	G	Housing	Housing
-	-	9	-	N.c.	Not connected
-	-	11	-	N.c.	Not connected
Shielding	-	-	-	Shielding	Screen connected to housing on encoder side





### Recommended accessories

Other models and accessories → [www.sick.com/DGS80\\_90](http://www.sick.com/DGS80_90)

	Brief description	Type	part no.
Mounting systems			
	<ul style="list-style-type: none"> <li><b>Product family:</b> Stator couplings</li> <li><b>Description:</b> 1-sided stator coupling, slot, 115 mm</li> <li><b>Details:</b> Stainless steel 1.4301 (AISI 304)</li> <li><b>Items supplied:</b> 1 x stator coupling, 3 x M3 screws, 1 x insulating washer for stator coupling</li> </ul>	DGS80-TETHER-A	2122697
	<ul style="list-style-type: none"> <li><b>Product family:</b> Stator couplings</li> <li><b>Description:</b> 1-sided stator coupling, slot, 84 mm</li> <li><b>Details:</b> Stainless steel 1.4301 (AISI 304)</li> <li><b>Items supplied:</b> 1 x stator coupling, 3 x M3 screws, 1 x insulating washer for stator coupling</li> </ul>	DGS80-TETHER-B	2122698
	<ul style="list-style-type: none"> <li><b>Product segment:</b> Shaft adaptation</li> <li><b>Product family:</b> Shaft couplings</li> <li><b>Description:</b> 1-sided stator coupling, slot, 67 mm</li> </ul>	DGS80-TETHER-C	2135677

	Brief description	Type	part no.
shaft adaptation			
	<ul style="list-style-type: none"> <li>• <b>Product segment:</b> Shaft adaptation</li> <li>• <b>Product:</b> Collets</li> <li>• <b>Description:</b> Collet for through hollow shaft, shaft diameter 1", external diameter 30 mm</li> </ul>	SPZ-030-01Z-M	2123015
	<ul style="list-style-type: none"> <li>• <b>Product segment:</b> Shaft adaptation</li> <li>• <b>Product:</b> Collets</li> <li>• <b>Description:</b> Collet for through hollow shaft, shaft diameter 16 mm, external diameter 30 mm</li> </ul>	SPZ-030-016-M	2123016
	<ul style="list-style-type: none"> <li>• <b>Product segment:</b> Shaft adaptation</li> <li>• <b>Product:</b> Collets</li> <li>• <b>Description:</b> Collet for through hollow shaft, shaft diameter 18 mm, external diameter 30 mm</li> </ul>	SPZ-030-018-M	2123017
	<ul style="list-style-type: none"> <li>• <b>Product segment:</b> Shaft adaptation</li> <li>• <b>Product:</b> Collets</li> <li>• <b>Description:</b> Collet for through hollow shaft, shaft diameter 20 mm, external diameter 30 mm</li> </ul>	SPZ-030-020-M	2123018
	<ul style="list-style-type: none"> <li>• <b>Product segment:</b> Shaft adaptation</li> <li>• <b>Product:</b> Collets</li> <li>• <b>Description:</b> Collet for through hollow shaft, shaft diameter 24 mm, external diameter 30 mm</li> </ul>	SPZ-030-024-M	2123019
	<ul style="list-style-type: none"> <li>• <b>Product segment:</b> Shaft adaptation</li> <li>• <b>Product:</b> Collets</li> <li>• <b>Description:</b> Collet for through hollow shaft, shaft diameter 25 mm, external diameter 30 mm</li> </ul>	SPZ-030-025-M	2123020
	<ul style="list-style-type: none"> <li>• <b>Product segment:</b> Shaft adaptation</li> <li>• <b>Product:</b> Collets</li> <li>• <b>Description:</b> Collet for through hollow shaft, shaft diameter 28 mm, external diameter 30 mm</li> </ul>	SPZ-030-028-M	2123021
	<ul style="list-style-type: none"> <li>• <b>Product segment:</b> Shaft adaptation</li> <li>• <b>Product:</b> Collets</li> <li>• <b>Description:</b> Collet for through hollow shaft, shaft diameter 3/4", external diameter 30 mm</li> </ul>	SPZ-030-034Z-M	2123014
	<ul style="list-style-type: none"> <li>• <b>Product segment:</b> Shaft adaptation</li> <li>• <b>Product:</b> Collets</li> <li>• <b>Description:</b> Collet for through hollow shaft, shaft diameter 5/8", external diameter 30 mm</li> </ul>	SPZ-030-058Z-M	2123013
	<ul style="list-style-type: none"> <li>• <b>Product segment:</b> Shaft adaptation</li> <li>• <b>Product:</b> Collets</li> <li>• <b>Description:</b> Collet for through hollow shaft, shaft diameter 1/2", external diameter 30 mm</li> </ul>	SPZ-030-012Z-M	2142263

	Brief description	Type	part no.
connectors and cables			
	<ul style="list-style-type: none"> <li>• <b>Connection type head A:</b> Female connector, M23, 12-pin, straight</li> <li>• <b>Connection type head B:</b> Flying leads</li> <li>• <b>Signal type:</b> Incremental</li> <li>• <b>Cable:</b> 2 m, 11-wire, PUR</li> <li>• <b>Description:</b> Incremental, shielded</li> <li>• <b>Application:</b> Zones with oils and lubricants</li> </ul>	DOL-2312-G02MLA3	2030682
	<ul style="list-style-type: none"> <li>• <b>Connection type head A:</b> Female connector, M23, 12-pin, straight</li> <li>• <b>Connection type head B:</b> Flying leads</li> <li>• <b>Signal type:</b> Incremental</li> <li>• <b>Cable:</b> 7 m, 11-wire, PUR</li> <li>• <b>Description:</b> Incremental, shielded</li> <li>• <b>Application:</b> Zones with oils and lubricants</li> </ul>	DOL-2312-G07MLA3	2030685
	<ul style="list-style-type: none"> <li>• <b>Connection type head A:</b> Female connector, M23, 12-pin, straight</li> <li>• <b>Connection type head B:</b> Flying leads</li> <li>• <b>Signal type:</b> Incremental</li> <li>• <b>Cable:</b> 10 m, 11-wire, PUR</li> <li>• <b>Description:</b> Incremental, shielded</li> <li>• <b>Application:</b> Zones with oils and lubricants</li> </ul>	DOL-2312-G10MLA3	2030688
	<ul style="list-style-type: none"> <li>• <b>Connection type head A:</b> Female connector, M23, 12-pin, straight</li> <li>• <b>Connection type head B:</b> Flying leads</li> <li>• <b>Signal type:</b> Incremental</li> <li>• <b>Cable:</b> 15 m, 11-wire, PUR</li> <li>• <b>Description:</b> Incremental, shielded</li> <li>• <b>Application:</b> Zones with oils and lubricants</li> </ul>	DOL-2312-G15MLA3	2030692
	<ul style="list-style-type: none"> <li>• <b>Connection type head A:</b> Female connector, M23, 12-pin, straight</li> <li>• <b>Connection type head B:</b> Flying leads</li> <li>• <b>Signal type:</b> Incremental</li> <li>• <b>Cable:</b> 20 m, 11-wire, PUR</li> <li>• <b>Description:</b> Incremental, shielded</li> <li>• <b>Application:</b> Zones with oils and lubricants</li> </ul>	DOL-2312-G20MLA3	2030695
	<ul style="list-style-type: none"> <li>• <b>Connection type head A:</b> Female connector, M23, 12-pin, straight</li> <li>• <b>Connection type head B:</b> Flying leads</li> <li>• <b>Signal type:</b> Incremental</li> <li>• <b>Cable:</b> 25 m, 11-wire, PUR</li> <li>• <b>Description:</b> Incremental, shielded</li> <li>• <b>Application:</b> Zones with oils and lubricants</li> </ul>	DOL-2312-G25MLA3	2030699
	<ul style="list-style-type: none"> <li>• <b>Connection type head A:</b> Female connector, M23, 12-pin, straight</li> <li>• <b>Connection type head B:</b> Flying leads</li> <li>• <b>Signal type:</b> Incremental</li> <li>• <b>Cable:</b> 30 m, 11-wire, PUR</li> <li>• <b>Description:</b> Incremental, shielded</li> <li>• <b>Application:</b> Zones with oils and lubricants</li> </ul>	DOL-2312-G30MLA3	2030702
	<ul style="list-style-type: none"> <li>• <b>Connection type head A:</b> Female connector, M23, 12-pin, straight</li> <li>• <b>Connection type head B:</b> Flying leads</li> <li>• <b>Signal type:</b> Incremental</li> <li>• <b>Cable:</b> 1.5 m, 12-wire, PUR, halogen-free</li> <li>• <b>Description:</b> Incremental, shielded</li> <li>• <b>Application:</b> Zones with oils and lubricants</li> </ul>	DOL-2312-G1M5MA3	2029212
	<ul style="list-style-type: none"> <li>• <b>Connection type head A:</b> Female connector, M23, 12-pin, straight</li> <li>• <b>Connection type head B:</b> Flying leads</li> <li>• <b>Signal type:</b> Incremental</li> <li>• <b>Cable:</b> 3 m, 12-wire, PUR, halogen-free</li> <li>• <b>Description:</b> Incremental, shielded</li> <li>• <b>Application:</b> Zones with oils and lubricants</li> </ul>	DOL-2312-G03MMA3	2029213
	<ul style="list-style-type: none"> <li>• <b>Connection type head A:</b> Female connector, M23, 12-pin, straight</li> <li>• <b>Connection type head B:</b> Flying leads</li> <li>• <b>Signal type:</b> Incremental</li> <li>• <b>Cable:</b> 5 m, 12-wire, PUR, halogen-free</li> <li>• <b>Description:</b> Incremental, shielded</li> <li>• <b>Application:</b> Zones with oils and lubricants</li> </ul>	DOL-2312-G05MMA3	2029214
	<ul style="list-style-type: none"> <li>• <b>Connection type head A:</b> Female connector, M23, 12-pin, straight</li> <li>• <b>Connection type head B:</b> Flying leads</li> <li>• <b>Signal type:</b> Incremental</li> <li>• <b>Cable:</b> 10 m, 12-wire, PUR, halogen-free</li> <li>• <b>Description:</b> Incremental, shielded</li> </ul>	DOL-2312-G10MMA3	2029215

	Brief description	Type	part no.
	<ul style="list-style-type: none"> <li>• <b>Application:</b> Zones with oils and lubricants</li> <li>• <b>Connection type head A:</b> Female connector, M23, 12-pin, straight</li> <li>• <b>Connection type head B:</b> Flying leads</li> <li>• <b>Signal type:</b> Incremental</li> <li>• <b>Cable:</b> 20 m, 12-wire, PUR, halogen-free</li> <li>• <b>Description:</b> Incremental, shielded</li> <li>• <b>Application:</b> Zones with oils and lubricants</li> </ul>	DOL-2312-G20MMA3	2029216
	<ul style="list-style-type: none"> <li>• <b>Connection type head A:</b> Female connector, M23, 12-pin, straight</li> <li>• <b>Connection type head B:</b> Flying leads</li> <li>• <b>Signal type:</b> Incremental</li> <li>• <b>Cable:</b> 30 m, 12-wire, PUR, halogen-free</li> <li>• <b>Description:</b> Incremental, shielded</li> <li>• <b>Application:</b> Zones with oils and lubricants</li> </ul>	DOL-2312-G30MMA3	2029217
	<ul style="list-style-type: none"> <li>• <b>Connection type head A:</b> Female connector, M23, 12-pin, straight, A-coded</li> <li>• <b>Signal type:</b> HIPERFACE<sup>®</sup>, SSI, Incremental</li> <li>• <b>Description:</b> HIPERFACE<sup>®</sup>, shielded, SSI, Incremental</li> <li>• <b>Connection systems:</b> Solder connection</li> </ul>	DOS-2312-G02	2077057
	<ul style="list-style-type: none"> <li>• <b>Connection type head A:</b> Female connector, M23, 12-pin, angled, A-coded</li> <li>• <b>Signal type:</b> HIPERFACE<sup>®</sup>, SSI, Incremental</li> <li>• <b>Description:</b> HIPERFACE<sup>®</sup>, shielded, SSI, Incremental</li> <li>• <b>Connection systems:</b> Solder connection</li> </ul>	DOS-2312-W01	2072580

## SICK AT A GLANCE

SICK is one of the leading manufacturers of intelligent sensors and sensor solutions for industrial applications. A unique range of products and services creates the perfect basis for controlling processes securely and efficiently, protecting individuals from accidents and preventing damage to the environment.

We have extensive experience in a wide range of industries and understand their processes and requirements. With intelligent sensors, we can deliver exactly what our customers need. In application centers in Europe, Asia and North America, system solutions are tested and optimized in accordance with customer specifications. All this makes us a reliable supplier and development partner.

Comprehensive services complete our offering: SICK LifeTime Services provide support throughout the machine life cycle and ensure safety and productivity.

For us, that is “Sensor Intelligence.”

## WORLDWIDE PRESENCE:

Contacts and other locations –[www.sick.com](http://www.sick.com)