



DFS60B-S1MA01024

DFS60

INCREMENTAL ENCODERS

SICK
Sensor Intelligence.



Ordering information

Type	part no.
DFS60B-S1MA01024	1118536

Other models and accessories → www.sick.com/DFS60

Illustration may differ



Detailed technical data

Safety-related parameters

MTTF_D (mean time to dangerous failure)	300 years (EN ISO 13849-1) ¹⁾
--	--

¹⁾ This product is a standard product and does not constitute a safety component as defined in the Machinery Directive. Calculation based on nominal load of components, average ambient temperature 40 °C, frequency of use 8760 h/a. All electronic failures are considered hazardous. For more information, see document no. 8015532.

Performance

Pulses per revolution	1,024 ¹⁾
Measuring step	90°, electric/pulses per revolution
Measuring step deviation at binary number of lines	± 0.008°
Error limits	± 0.05°

¹⁾ See maximum revolution range.

Interfaces

Communication interface	Incremental
Communication Interface detail	TTL / HTL
Factory setting	Factory setting: output level TTL
Number of signal channels	6-channel
0-set function via hardware pin	✓
0-SET function	H-active, L = 0 - 3 V, H = 4,0 - U _s V ¹⁾
Programmable/configurable	✓
Initialization time	32 ms, 30 ms ²⁾
Output frequency	≤ 600 kHz

¹⁾ Only with devices with M23 connector in connection with electrical interfaces M, U, V and W.

²⁾ With mechanical zero pulse width.

Load current	≤ 30 mA
Power consumption	≤ 0.7 W (without load)

¹⁾ Only with devices with M23 connector in connection with electrical interfaces M, U, V and W.

²⁾ With mechanical zero pulse width.

Electronics

Connection type	Male connector, M23, 12-pin, radial
Supply voltage	4.5 ... 32 V
Reference signal, number	1
Reference signal, position	90°, electric, logically gated with A and B
Reverse polarity protection	✓
Short-circuit protection of the outputs	✓ ¹⁾ ²⁾

¹⁾ Programming TTL with ≥ 5.5 V: short-circuit opposite to another channel or GND permissible for maximum 30 s.

²⁾ Programming HTL or TTL with < 5.5 V: short-circuit opposite to another channel, US or GND permissible for maximum 30 s.

Mechanics

Mechanical design	Solid shaft, Servo flange
Shaft diameter	6 mm With flat
Shaft length	10 mm
Weight	+ 0.3 kg
Shaft material	Stainless steel
Flange material	Aluminum
Housing material	Aluminum die cast
Start up torque	0.5 Ncm (+20 °C)
Operating torque	0.3 Ncm (+20 °C)
Permissible shaft loading	80 N (radial) 40 N (axial)
Operating speed	≤ 9,000 min ⁻¹ ¹⁾
Moment of inertia of the rotor	6.2 gcm ²
Bearing lifetime	3.6 x 10 ¹⁰ revolutions
Angular acceleration	≤ 500,000 rad/s ²

¹⁾ Allow for self-heating of 3.3 K per 1,000 rpm when designing the operating temperature range.

Ambient data

EMC	According to EN 61000-6-2 and EN 61000-6-3
Enclosure rating	IP67, Housing side, male connector (IEC 60529) ¹⁾ IP65, shaft side (IEC 60529)
Permissible relative humidity	90 % (Condensation not permitted)
Operating temperature range	-40 °C ... +100 °C ²⁾ -30 °C ... +100 °C ³⁾
Storage temperature range	-40 °C ... +100 °C, without package

¹⁾ With mating connector fitted.

²⁾ Stationary position of the cable.

³⁾ Flexible position of the cable.

Resistance to shocks	70 g, 6 ms (EN 60068-2-27)
Resistance to vibration	30 g, 10 Hz ... 2,000 Hz (EN 60068-2-6)

- 1) With mating connector fitted.
- 2) Stationary position of the cable.
- 3) Flexible position of the cable.

Certificates

EU declaration of conformity	✓
UK declaration of conformity	✓
ACMA declaration of conformity	✓
Moroccan declaration of conformity	✓
China RoHS	✓
cULus certificate	✓
Information according to Art. 3 of Data Act (Regulation EU 2023/2854)	✓

Classifications

ECLASS 5.0	27270501
ECLASS 5.1.4	27270501
ECLASS 6.0	27270590
ECLASS 6.2	27270590
ECLASS 7.0	27270501
ECLASS 8.0	27270501
ECLASS 8.1	27270501
ECLASS 9.0	27270501
ECLASS 10.0	27270501
ECLASS 11.0	27270501
ECLASS 12.0	27270501
ETIM 5.0	EC001486
ETIM 6.0	EC001486
ETIM 7.0	EC001486
ETIM 8.0	EC001486
UNSPSC 16.0901	41112113

Dimensional drawing



Dimensions in mm (inch)

Mounting requirements for half-shell servo clamp

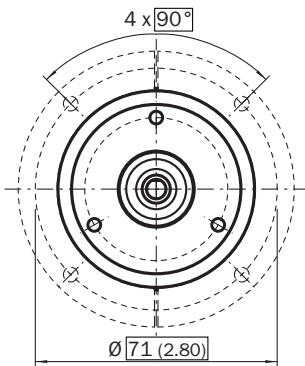

All dimensions in mm (inch)
part no. 2029165

Mounting requirements for small servo clamp

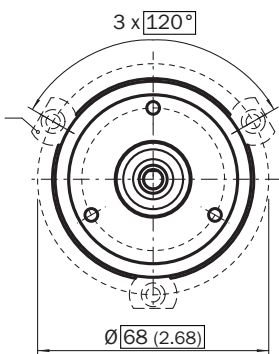

All dimensions in mm (inch)
part no. 2029166

PIN assignment

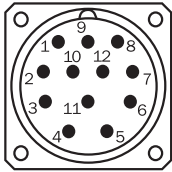

view of M23 male device connector on encoder

PIN Male connector M12, 8-pin	PIN Male connector M23, 12-pin	Wire colors (cable connection)	TTL/HTL signal	Sin/Cos 1.0 V _{PP}	Explanation
1	6	Brown	\bar{A}	COS-	Signal wire
2	5	White	A	COS+	Signal wire
3	1	Black	\bar{B}	SIN-	Signal wire
4	8	Pink	B	SIN+	Signal wire
5	4	Yellow	\bar{Z}	\bar{Z}	Signal wire
6	3	Purple	Z	Z	Signal wire
7	10	Blue	GND	GND	Ground connection
8	12	Red	+U _S	+U _S	Supply voltage
-	9	-	N.c.	N.c.	Not assigned
-	2	-	N.c.	N.c.	Not assigned
-	11	-	N.c.	N.c.	Not assigned
-	7 ¹⁾	Orange	0-SET ¹⁾	N.c.	Set zero pulse ¹⁾
Screen	Screen	Screen	Screen	Screen	Screen connected to housing on encoder side. Connected to ground on control side.

¹⁾For electrical interfaces only: M, U, V, W with 0-SET function on PIN 7 on M23 plug. The 0-SET input is used to set the zero pulse to the current shaft position. If the 0-SET input is applied to US for longer than 250 ms after it has previously been open or applied to GND for at least 1,000 ms, the current shaft position is assigned zero pulse signal "Z".

maximum revolution range

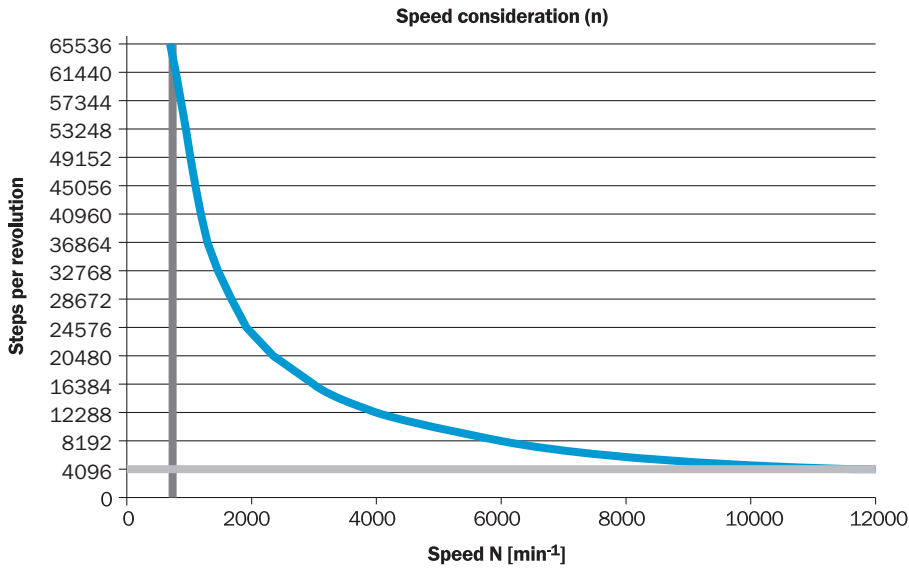

Diagrams Electrical zero pulse width can be configured to 90°, 180°, or 270°. Width of the zero pulse in relation to a pulse period.

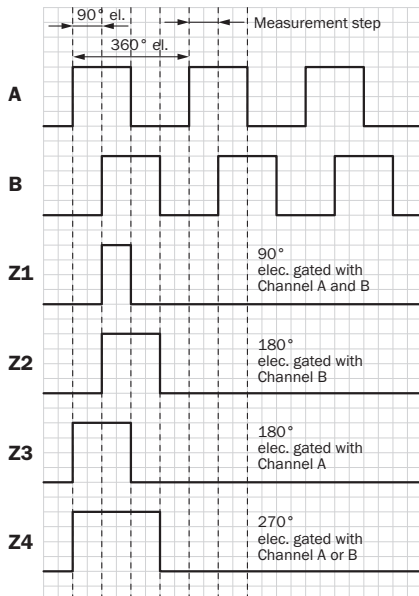

Cw with view on the encoder shaft in direction "A", compare dimensional drawing.

Supply voltage	Output
4,5 V ... 32 V	TTL/HTL programmable



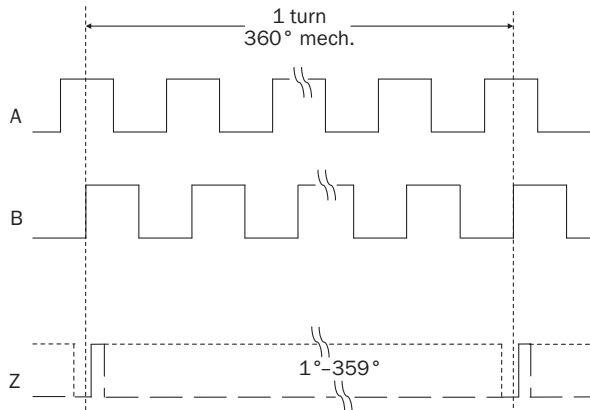



Diagrams Mechanical zero pulse width 1° to 359° programmable. Width of the zero pulse in relation to a mechanical revolution of the shaft.





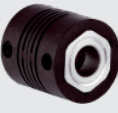

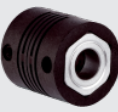
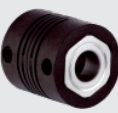
Supply voltage	Output
4,5 V ... 32 V	TTL/HTL programmable

Recommended accessories





Other models and accessories → www.sick.com/DFS60

	Brief description	Type	part no.
shaft adaptation			
	<ul style="list-style-type: none"> Product segment: Shaft adaptation Product: Shaft couplings Description: Bellows coupling, shaft diameter 6 mm / 10 mm, maximum shaft offset: radial ± 0.25 mm, axial ± 0.4 mm, angular +/- 4°; max. speed 10,000 rpm, -30 °C to +120 °C, max. torque 120 Ncm; material: stainless steel bellows, aluminum hub 	KUP-0610-B	5312982
	<ul style="list-style-type: none"> Product segment: Shaft adaptation Product: Shaft couplings Description: Double loop coupling, shaft diameter 6 mm / 10 mm, max. shaft offset: radially +/- 2,5 mm, axially +/- 3 mm, angle +/- 10 degrees; max. speed 3.000 rpm, -30 to +80 degrees Celsius, torsional spring stiffness of 25 Nm/rad 	KUP-0610-D	5326697
	<ul style="list-style-type: none"> Product segment: Shaft adaptation Product: Shaft couplings Description: Spring washer coupling, shaft diameter 6 mm / 10 mm, Maximum shaft offset: radial +/- 0.3 mm, axial +/- 0.4 mm, angular +/- 2.5°; max. speed 12,000 rpm, -10° to +80 °C, max. torque 60 Ncm; material: aluminum flange, glass fiber-reinforced polyamide membrane and hardened steel coupling pin 	KUP-0610-F	5312985
	<ul style="list-style-type: none"> Product segment: Shaft adaptation Product: Shaft couplings Description: Bar coupling, shaft diameter 6 mm / 10 mm, max. shaft offset: radial ± 0,3 mm, axial ± 0,3 mm, angular ± 3°; max. speed 10.000 rpm, -10° to +80 °C, max. torque: 80 Ncm, material: fiber-glass reinforced polyamide, aluminum hub 	KUP-0610-S	2056407
	<ul style="list-style-type: none"> Product segment: Shaft adaptation Product: Shaft couplings Description: Claw coupling, shaft diameter 6 mm / 10 mm, damping element 80 shore blue, maximum shaft offset: radial ± 0.22 mm, axial ± 1 mm angular ± 1.3°, max. speed 19,000 rpm, angle of twist max. 10°, -30 °C to +80 °C, max. torque 800 Ncm, tightening torque of screws: ISO 4029 150 Ncm, material: aluminum flange, damping element: polyurethane 	KUP-0610-J	2127056
	<ul style="list-style-type: none"> Product segment: Shaft adaptation Product: Shaft couplings Description: Bar coupling, shaft diameter 6 mm / 8 mm, maximum shaft offset radial ± 0.3 mm, axial ± 0.2 mm, angle ± 3°, max. speed 10,000 rpm, torsion spring rigidity 38 Nm/wheel; material: fiber-glass reinforced polyamide, aluminum hub 	KUP-0608-S	5314179
	<ul style="list-style-type: none"> Product segment: Shaft adaptation Product: Shaft couplings Description: Cross-slotted coupling, shaft diameter 6 mm / 6 mm, maximum shaft offset: radial ± 0.3 mm, axial ± 0.2 mm, angle ± 3°; max. speed 10,000 rpm, -10° to +80 °C, max. torque 80 Ncm; material: fiber-glass reinforced polyamide, aluminum hub 	KUP-0606-S	2056406
	<ul style="list-style-type: none"> Product segment: Shaft adaptation Product: Shaft couplings Description: Bellows coupling, shaft diameter 6 mm / 6 mm, maximum shaft offset: radial ± 0.25 mm, axial ± 0.4 mm, angular +/- 4°; max. speed 10,000 rpm, -30 °C to +120 °C, max. torque 120 Ncm; material: stainless steel bellows, aluminum hub 	KUP-0606-B	5312981

	Brief description	Type	part no.
measuring wheels and measuring wheel mechanics			
	<ul style="list-style-type: none"> Product segment: Measuring wheels and measuring wheel mechanics Product: Measuring wheels Description: Aluminum measuring wheel with studded polyurethane surface for 6 mm solid shaft, circumference 200 mm 	BEF-MR06200APN	4084747
	<ul style="list-style-type: none"> Product segment: Measuring wheels and measuring wheel mechanics Product: Measuring wheels Description: Aluminium measuring wheel with O-ring (NBR70) for 6 mm solid shaft, circumference 200 mm 	BEF-MR006020R	2055222
	<ul style="list-style-type: none"> Product segment: Measuring wheels and measuring wheel mechanics Product: Measuring wheels Description: Measuring wheel with O-ring (NBR70) for 6 mm solid shaft, circumference 300 mm 	BEF-MR006030R	2055634
	<ul style="list-style-type: none"> Product segment: Measuring wheels and measuring wheel mechanics Product: Measuring wheels Description: Aluminium measuring wheel with O-ring (NBR70) for 6 mm solid shaft, circumference 500 mm 	BEF-MR006050R	2055225
	<ul style="list-style-type: none"> Product segment: Measuring wheels and measuring wheel mechanics Product: Measuring wheels Description: Aluminum measuring wheel with cross-knurled surface for 6 mm solid shaft, circumference 200 mm 	BEF-MR06200AK	4084745
	<ul style="list-style-type: none"> Product segment: Measuring wheels and measuring wheel mechanics Product: Measuring wheels Description: Aluminum measuring wheel with smooth polyurethane surface for 6 mm solid shaft, circumference 200 mm 	BEF-MR06200AP	4084746
	<ul style="list-style-type: none"> Product segment: Measuring wheels and measuring wheel mechanics Product: Measuring wheels Description: Aluminum measuring wheel with ridged polyurethane surface for 6 mm solid shaft, circumference 200 mm 	BEF-MR06200APG	4084748

	Brief description	Type	part no.
Mounting systems			
	<ul style="list-style-type: none"> Description: Bearing block for servo and face mount flange encoder. The heavy-duty bearing block is used to absorb very large radial and axial shaft loads. Particularly when using belt pulleys, chain sprockets, friction wheels. Operating speed max. 4,000 rpm⁻¹, axial shaft load 150 N, radial shaft load 250 N, bearing service life 3.6 x 10⁹ revolutions 	BEF-FA-LB1210	2044591
	<ul style="list-style-type: none"> Description: Mounting kit for servo flange encoder on the bearing block, 1 bar coupling SKPS 1520 06/06 1 hexagon socket wrench SW1.5 DIN 911, 3 mounting eccentric BEMN 1242 49 3 screws M4 x 10 DIN 912, 1 hexagon socket wrench SW3 DIN 911 Items supplied: 1 bar coupling SKPS 1520 06/06 1 hexagon socket wrench SW1.5 DIN 911, 3 mounting eccentric BEMN 1242 49 3 screws M4 x 10 DIN 912, 1 hexagon socket wrench SW3 DIN 911 	BEF-MK-LB	5320872
	<ul style="list-style-type: none"> Description: Servo clamps, large, for servo flange (clamps, eccentric fastener), 3 pcs, without mounting material Items supplied: Without mounting hardware 	BEF-WK-SF	2029166
	<ul style="list-style-type: none"> Description: Mounting bell for encoder with servo flange, 50 mm spigot Items supplied: Mounting kit included 	BEF-MG-50	5312987
programming devices			
	<ul style="list-style-type: none"> Product segment: Programming devices Product: PGT-10 Pro Description: Programming unit display for programmable SICK DFS60, DFV60, AFS/AFM60, AHS/AHM36 encoders, and wire draw encoder with DFS60, AFS/AFM60 and AHS/AHM36. Compact dimensions, low weight, and intuitive operation. Items supplied: 1 x PGT-10-Pro stand-alone programming tool, 4 x alkaline type batteries, 1.5 V Mignon (AA) 	PGT-10-Pro	1072254
	<ul style="list-style-type: none"> Product segment: Programming devices Product: PGT-08-S Description: USB programming unit, for programmable SICK encoders AFS60, AFM60, DFS60, VFS60, DFV60 and wire draw encoders with programmable encoders. Not compatible with the portable SOPAS ET versions. 	PGT-08-S	1036616

	Brief description	Type	part no.
connectors and cables			
	<ul style="list-style-type: none"> Description: Incremental, shielded Connection type head A: Female connector, M23, 12-pin, straight Connection type head B: Flying leads Signal type: Incremental Cable: 15 m, 11-wire, PUR Application: Zones with oils and lubricants 	DOL-2312-G15MLD1	2062205
	<ul style="list-style-type: none"> Description: Incremental, shielded Connection type head A: Female connector, M23, 12-pin, straight Connection type head B: Flying leads Signal type: Incremental Cable: 2 m, 11-wire, PUR Application: Zones with oils and lubricants 	DOL-2312-G02MLD1	2062202
	<ul style="list-style-type: none"> Description: Incremental, shielded Connection type head A: Female connector, M23, 12-pin, straight Connection type head B: Flying leads Signal type: Incremental Cable: 7 m, 11-wire, PUR Application: Zones with oils and lubricants 	DOL-2312-G07MLD1	2062203
	<ul style="list-style-type: none"> Description: Incremental, shielded Connection type head A: Female connector, M23, 12-pin, straight Connection type head B: Flying leads Signal type: Incremental Cable: 10 m, 11-wire, PUR Application: Zones with oils and lubricants 	DOL-2312-G10MLD1	2062204
	<ul style="list-style-type: none"> Description: Incremental, shielded Connection type head A: Female connector, M23, 12-pin, straight Connection type head B: Flying leads Signal type: Incremental Cable: 20 m, 11-wire, PUR Application: Zones with oils and lubricants 	DOL-2312-G20MLD1	2062206
	<ul style="list-style-type: none"> Description: Incremental, shielded Connection type head A: Female connector, M23, 12-pin, straight Connection type head B: Flying leads Signal type: Incremental Cable: 25 m, 11-wire, PUR Application: Zones with oils and lubricants 	DOL-2312-G25MLD1	2062207
	<ul style="list-style-type: none"> Description: Incremental, shielded Connection type head A: Female connector, M23, 12-pin, straight Connection type head B: Flying leads Signal type: Incremental Cable: 30 m, 11-wire, PUR Application: Zones with oils and lubricants 	DOL-2312-G30MLD1	2062208
	<ul style="list-style-type: none"> Description: Incremental, shielded Connection type head A: Female connector, M23, 12-pin, straight Connection type head B: Flying leads Signal type: Incremental Cable: 1.5 m, 12-wire, PUR, halogen-free Application: Zones with oils and lubricants 	DOL-2312-G1M5MD1	2062240
	<ul style="list-style-type: none"> Description: Incremental, shielded Connection type head A: Female connector, M23, 12-pin, straight Connection type head B: Flying leads Signal type: Incremental Cable: 3 m, 12-wire, PUR, halogen-free Application: Zones with oils and lubricants 	DOL-2312-G03MMD1	2062243
	<ul style="list-style-type: none"> Description: Incremental, shielded Connection type head A: Female connector, M23, 12-pin, straight Connection type head B: Flying leads Signal type: Incremental Cable: 5 m, 12-wire, PUR, halogen-free Application: Zones with oils and lubricants 	DOL-2312-G05MMD1	2062244
	<ul style="list-style-type: none"> Description: Incremental, shielded Connection type head A: Female connector, M23, 12-pin, straight Connection type head B: Flying leads Signal type: Incremental Cable: 10 m, 12-wire, PUR, halogen-free 	DOL-2312-G10MMD1	2062245

	Brief description	Type	part no.
	<ul style="list-style-type: none"> • Application: Zones with oils and lubricants • Description: Incremental, shielded • Connection type head A: Female connector, M23, 12-pin, straight • Connection type head B: Flying leads • Signal type: Incremental • Cable: 20 m, 12-wire, PUR, halogen-free • Application: Zones with oils and lubricants 	DOL-2312-G20MMD1	2062246
	<ul style="list-style-type: none"> • Description: Incremental, shielded • Connection type head A: Female connector, M23, 12-pin, straight • Connection type head B: Flying leads • Signal type: Incremental • Cable: 30 m, 12-wire, PUR, halogen-free • Application: Zones with oils and lubricants 	DOL-2312-G30MMD1	2062247
	<ul style="list-style-type: none"> • Connection type head A: Female connector, M23, 12-pin, straight • Connection type head B: Male connector, D-Sub, 9-pin, straight • Signal type: Incremental • Cable: 0.5 m, 8-wire • Description: Incremental, shielded • Note: Programming adapter cable for programming tool PGT-10-Pro and PGT-08-S 	DSL-3D08-G0M5AC3	2046580
	<ul style="list-style-type: none"> • Description: HIAPERFACE[®], shielded, SSI, Incremental • Connection type head A: Female connector, M23, 12-pin, straight, A-coded • Signal type: HIAPERFACE[®], SSI, Incremental • Connection systems: Solder connection 	DOS-2312-G02	2077057
	<ul style="list-style-type: none"> • Description: HIAPERFACE[®], shielded, SSI, Incremental • Connection type head A: Female connector, M23, 12-pin, angled, A-coded • Signal type: HIAPERFACE[®], SSI, Incremental • Connection systems: Solder connection 	DOS-2312-W01	2072580

SICK AT A GLANCE

SICK is one of the leading manufacturers of intelligent sensors and sensor solutions for industrial applications. A unique range of products and services creates the perfect basis for controlling processes securely and efficiently, protecting individuals from accidents and preventing damage to the environment.

We have extensive experience in a wide range of industries and understand their processes and requirements. With intelligent sensors, we can deliver exactly what our customers need. In application centers in Europe, Asia and North America, system solutions are tested and optimized in accordance with customer specifications. All this makes us a reliable supplier and development partner.

Comprehensive services complete our offering: SICK LifeTime Services provide support throughout the machine life cycle and ensure safety and productivity.

For us, that is “Sensor Intelligence.”

WORLDWIDE PRESENCE:

Contacts and other locations –www.sick.com