



# IHM06-1B5PSVT0K

IMM

INDUCTIVE PROXIMITY SENSORS

**SICK**  
Sensor Intelligence.



### Ordering information

Type	part no.
IHM06-1B5PSVT0K	1114596

Other models and accessories → [www.sick.com/IMM](http://www.sick.com/IMM)

Illustration may differ



### Detailed technical data

#### Features

<b>Housing</b>	Cylindrical
<b>Housing</b>	Short-body
<b>Diameter</b>	Ø 6.5 mm
<b>Sensing range S<sub>n</sub></b>	1.5 mm
<b>Safe sensing range S<sub>a</sub></b>	1.215 mm
<b>Installation type</b>	Flush
<b>Switching frequency</b>	5,000 Hz
<b>Connection type</b>	Connector M8, 3-pin
<b>Switching output</b>	PNP
<b>Switching output detail</b>	PNP
<b>Output function</b>	NO
<b>Electrical wiring</b>	DC 3-wire
<b>Enclosure rating</b>	IP67 <sup>1)</sup>
<b>Special features</b>	Visual adjustment indicator

<sup>1)</sup> According to EN 60529.

#### Mechanics/electronics

<b>Supply voltage</b>	10 V DC ... 30 V DC
<b>Ripple</b>	≤ 20 % <sup>1)</sup>

<sup>1)</sup> Of V<sub>S</sub>.

<sup>2)</sup> With I<sub>a</sub> = 200 mA.

<sup>3)</sup> Supply voltage U<sub>B</sub> and constant ambient temperature T<sub>a</sub>.

<b>Voltage drop</b>	$\leq 2 \text{ V}^{2)}$
<b>Time delay before availability</b>	$\leq 50 \text{ ms}$
<b>Hysteresis</b>	1 % ... 10 %
<b>Reproducibility</b>	$\leq 2 \%^{3)}$
<b>Temperature drift (of <math>S_r</math>)</b>	$\leq 10 \%$
<b>EMC</b>	EN 60947-5-2
<b>Continuous current <math>I_a</math></b>	$\leq 200 \text{ mA}$
<b>Short-circuit protection</b>	✓
<b>Power-up pulse protection</b>	✓
<b>Shock and vibration resistance</b>	30 g, 11 ms / 10 ... 55 Hz, 1 mm
<b>Ambient operating temperature</b>	-25 °C ... +70 °C
<b>Housing material</b>	Stainless steel V2A, DIN 1.4305 / AISI 303
<b>Sensing face material</b>	Plastic, LCP
<b>Housing length</b>	40 mm
<b>UL File No.</b>	NRKH.E348498

1) Of  $V_S$ .

2) With  $I_a = 200 \text{ mA}$ .

3) Supply voltage  $U_B$  and constant ambient temperature  $T_a$ .

### Safety-related parameters

<b>MTTF<sub>D</sub></b>	1,330 years
<b>DC<sub>avg</sub></b>	0 %

### Communication interface

<b>Communication interface</b>	IO-Link V1.1
<b>Communication Interface detail</b>	COM2 (38,4 kBaud)
<b>Cycle time</b>	10.4 ms
<b>Process data length</b>	1 Byte
<b>Process data structure</b>	Bit 0 = $S_r$ reached Bit 1 = $S_a$ reached

### Reduction factors

<b>Note</b>	The values are reference values which may vary
<b>St37 steel (Fe)</b>	1
<b>Stainless steel (V2A, 304)</b>	Approx. 0.75
<b>Aluminum (Al)</b>	Approx. 0.5
<b>Copper (Cu)</b>	Approx. 0.43
<b>Brass (Br)</b>	Approx. 0.54

### Installation note

<b>Remark</b>	Associated graphic see "Installation"
<b>B</b>	6 mm
<b>C</b>	6.5 mm
<b>D</b>	4.5 mm
<b>F</b>	12 mm

Certificates

<b>EU declaration of conformity</b>	✓
<b>UK declaration of conformity</b>	✓
<b>ACMA declaration of conformity</b>	✓
<b>Moroccan declaration of conformity</b>	✓
<b>China RoHS</b>	✓
<b>cULus certificate</b>	✓
<b>IO-Link certificate</b>	✓
<b>Information according to Art. 3 of Data Act (Regulation EU 2023/2854)</b>	✓

Classifications

<b>ECLASS 5.0</b>	27270101
<b>ECLASS 5.1.4</b>	27270101
<b>ECLASS 6.0</b>	27270101
<b>ECLASS 6.2</b>	27270101
<b>ECLASS 7.0</b>	27270101
<b>ECLASS 8.0</b>	27270101
<b>ECLASS 8.1</b>	27270101
<b>ECLASS 9.0</b>	27270101
<b>ECLASS 10.0</b>	27270101
<b>ECLASS 11.0</b>	27270101
<b>ECLASS 12.0</b>	27274001
<b>ETIM 5.0</b>	EC002714
<b>ETIM 6.0</b>	EC002714
<b>ETIM 7.0</b>	EC002714
<b>ETIM 8.0</b>	EC002714
<b>UNSPSC 16.0901</b>	39122230

Installation note Mounting using BEF-KH-M06 bracket

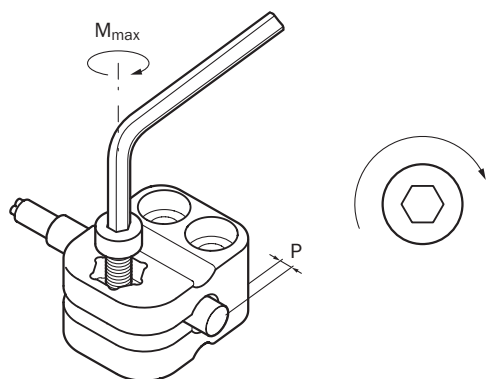

Sensor type	Mounting adapter	Overrun (P)	Max. tightening torque ( $M_{max}$ )
IHM06-1B5*****	BEF-KH-M06, part no. 2101067	$\geq 0$ mm	$\leq 0.6$ Nm

Sensor type	Mounting adapter	Overrun (P)	Max. tightening torque ( $M_{max}$ )
IHM06-02B***** IHM06-03B*****			

Installation note Fixing with setscrew

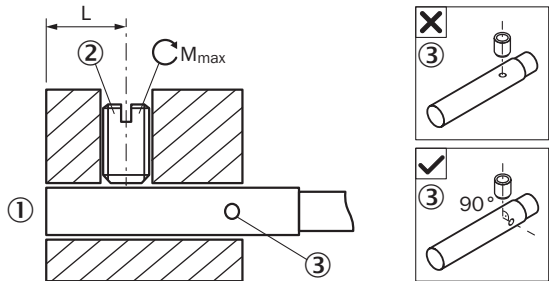

- ① Sensing face
- ② Recommended setscrew: M3, flat point
- ③ Display LED

Sensor type	Mounting area (L)	Max. tightening torque ( $M_{max}$ )
IHM06-*****G	6 mm ... 11 mm	$\leq 0.4$ Nm
IHM06-*****TOG	6 mm ... 21 mm	$\leq 0.4$ Nm
IHM06-*****K	6 mm ... 21 mm	$\leq 0.4$ Nm
IHM06-*****TOK	6 mm ... 32 mm	$\leq 0.4$ Nm
IHM06-*****S	6 mm ... 32 mm	$\leq 0.4$ Nm
IHM06-*****TOS	6 mm ... 42 mm	$\leq 0.4$ Nm

Installation note Flush installation

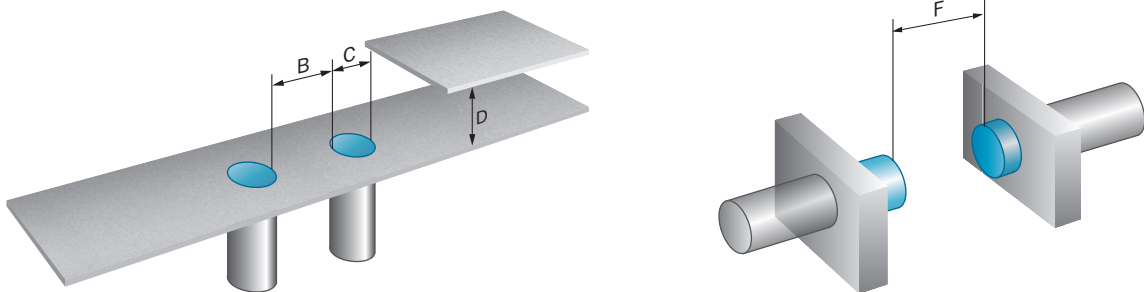

Connection diagram Cd-002

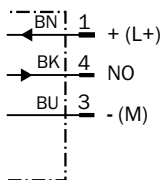

**Response diagram**

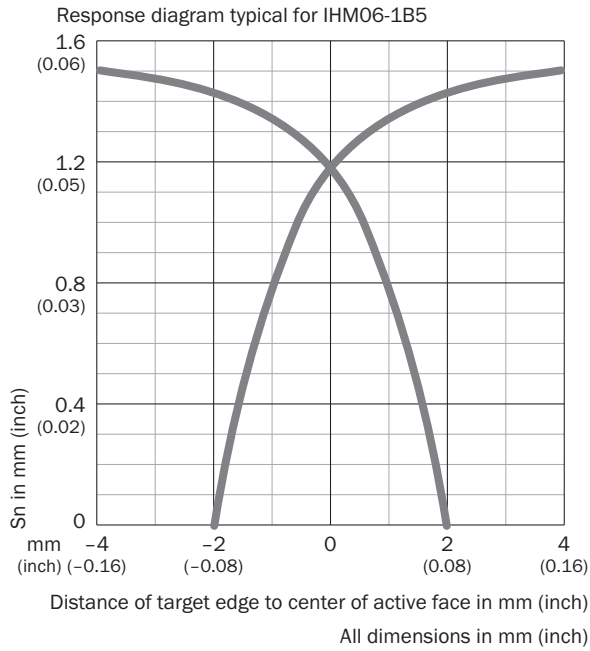

**Functional principle Installation aid**

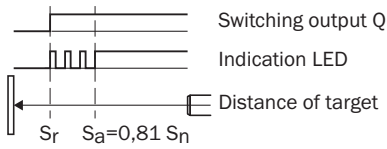

**Dimensional drawing IHM06, short variant, flush, male connector**

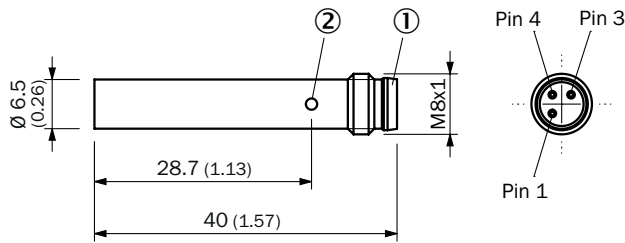

Dimensions in mm (inch)  
 ① Connection  
 ② function indicator



Recommended accessories

Other models and accessories → [www.sick.com/IMM](http://www.sick.com/IMM)

	Brief description	Type	part no.
Mounting systems			
	<ul style="list-style-type: none"><li>• <b>Material:</b> Plastic</li><li>• <b>Details:</b> Plastic (PA6)</li><li>• <b>Items supplied:</b> Without mounting hardware</li><li>• <b>Usable for:</b> Round sensors with 6.5 mm housing diameter without fixed stop</li></ul>	BEF-KH-M06	2101067

	Brief description	Type	part no.
connectors and cables			
	<ul style="list-style-type: none"> <li>• <b>Number of slots:</b> 4</li> <li>• <b>Slot connection type:</b> M8, 3-pin, A-coded, female connector</li> <li>• <b>Items supplied:</b> 5 x labeling plates</li> <li>• <b>Description:</b> Unshielded</li> </ul>	Y8A34A2-C2A8000XXX	2115733
	<ul style="list-style-type: none"> <li>• <b>Number of slots:</b> 4</li> <li>• <b>Slot connection type:</b> M8, 3-pin, A-coded, female connector</li> <li>• <b>Items supplied:</b> 5 x labeling plates</li> <li>• <b>Cable:</b> 5 m, 6-wire, PUR, halogen-free</li> <li>• <b>Description:</b> Unshielded</li> <li>• <b>Application:</b> Drag chain operation</li> </ul>	Y8A34A2-LXXXUAA050	2115727
	<ul style="list-style-type: none"> <li>• <b>Number of slots:</b> 6</li> <li>• <b>Slot connection type:</b> M8, 3-pin, A-coded, female connector</li> <li>• <b>Items supplied:</b> 5 x labeling plates</li> <li>• <b>Description:</b> Unshielded</li> </ul>	Y8A36A2-C2A8000XXX	2115734
	<ul style="list-style-type: none"> <li>• <b>Number of slots:</b> 6</li> <li>• <b>Slot connection type:</b> M8, 3-pin, A-coded, female connector</li> <li>• <b>Items supplied:</b> 5 x labeling plates</li> <li>• <b>Cable:</b> 5 m, 8-wire, PUR, halogen-free</li> <li>• <b>Description:</b> Unshielded</li> <li>• <b>Application:</b> Drag chain operation</li> </ul>	Y8A36A2-LXXXUBA050	2115728
	<ul style="list-style-type: none"> <li>• <b>Description:</b> Sensor/actuator cable, unshielded</li> <li>• <b>Connection type head A:</b> Female connector, M8, 3-pin, straight, A-coded</li> <li>• <b>Connection type head B:</b> Flying leads</li> <li>• <b>Signal type:</b> Sensor/actuator cable</li> <li>• <b>Cable:</b> 2 m, 3-wire, PUR, halogen-free</li> <li>• <b>Application:</b> Drag chain operation, Zones with oils and lubricants, Robot, Drag chain operation</li> </ul>	YF8U13-020UA1XLEAX	2094782
	<ul style="list-style-type: none"> <li>• <b>Description:</b> Sensor/actuator cable, unshielded</li> <li>• <b>Connection type head A:</b> Female connector, M8, 3-pin, straight, A-coded</li> <li>• <b>Connection type head B:</b> Flying leads</li> <li>• <b>Signal type:</b> Sensor/actuator cable</li> <li>• <b>Cable:</b> 5 m, 3-wire, PUR, halogen-free</li> <li>• <b>Application:</b> Drag chain operation, Zones with oils and lubricants, Robot, Drag chain operation</li> </ul>	YF8U13-050UA1XLEAX	2094788
	<ul style="list-style-type: none"> <li>• <b>Description:</b> Sensor/actuator cable, unshielded</li> <li>• <b>Connection type head A:</b> Female connector, M8, 3-pin, straight, A-coded</li> <li>• <b>Connection type head B:</b> Flying leads</li> <li>• <b>Signal type:</b> Sensor/actuator cable</li> <li>• <b>Cable:</b> 2 m, 3-wire, PVC</li> <li>• <b>Application:</b> Uncontaminated zones, Zones with chemicals</li> </ul>	YF8U13-020VA1XLEAX	2095860
	<ul style="list-style-type: none"> <li>• <b>Description:</b> Sensor/actuator cable, unshielded</li> <li>• <b>Connection type head A:</b> Female connector, M8, 3-pin, straight, A-coded</li> <li>• <b>Connection type head B:</b> Flying leads</li> <li>• <b>Signal type:</b> Sensor/actuator cable</li> <li>• <b>Cable:</b> 5 m, 3-wire, PVC</li> <li>• <b>Application:</b> Uncontaminated zones, Zones with chemicals</li> </ul>	YF8U13-050VA1XLEAX	2095884
	<ul style="list-style-type: none"> <li>• <b>Description:</b> Sensor/actuator cable, unshielded</li> <li>• <b>Connection type head A:</b> Female connector, M8, 3-pin, angled, A-coded</li> <li>• <b>Connection type head B:</b> Flying leads</li> <li>• <b>Signal type:</b> Sensor/actuator cable</li> <li>• <b>Cable:</b> 2 m, 3-wire, PUR, halogen-free</li> <li>• <b>Application:</b> Drag chain operation, Zones with oils and lubricants, Robot, Drag chain operation</li> </ul>	YG8U13-020UA1XLEAX	2094794
	<ul style="list-style-type: none"> <li>• <b>Description:</b> Sensor/actuator cable, unshielded</li> <li>• <b>Connection type head A:</b> Female connector, M8, 3-pin, angled, A-coded</li> <li>• <b>Connection type head B:</b> Flying leads</li> <li>• <b>Signal type:</b> Sensor/actuator cable</li> <li>• <b>Cable:</b> 5 m, 3-wire, PUR, halogen-free</li> <li>• <b>Application:</b> Drag chain operation, Zones with oils and lubricants, Robot, Drag chain operation</li> </ul>	YG8U13-050UA1XLEAX	2095586
	<ul style="list-style-type: none"> <li>• <b>Description:</b> Sensor/actuator cable, unshielded</li> <li>• <b>Connection type head A:</b> Female connector, M8, 3-pin, angled, A-coded</li> <li>• <b>Connection type head B:</b> Flying leads</li> <li>• <b>Signal type:</b> Sensor/actuator cable</li> <li>• <b>Cable:</b> 2 m, 3-wire, PVC</li> </ul>	YG8U13-020VA1XLEAX	2096165

	Brief description	Type	part no.
	<ul style="list-style-type: none"> <li><b>Application:</b> Uncontaminated zones, Zones with chemicals</li> <li><b>Description:</b> Sensor/actuator cable, unshielded</li> <li><b>Connection type head A:</b> Female connector, M8, 3-pin, angled, A-coded</li> <li><b>Connection type head B:</b> Flying leads</li> <li><b>Signal type:</b> Sensor/actuator cable</li> <li><b>Cable:</b> 5 m, 3-wire, PVC</li> <li><b>Application:</b> Uncontaminated zones, Zones with chemicals</li> </ul>	YG8U13-050VA1XLEAX	2096166
	<ul style="list-style-type: none"> <li><b>Description:</b> Sensor/actuator cable, unshielded</li> <li><b>Connection type head A:</b> Female connector, M8, 3-pin, straight, A-coded</li> <li><b>Connection type head B:</b> Male connector, M12, 3-pin, straight, A-coded</li> <li><b>Signal type:</b> Sensor/actuator cable</li> <li><b>Cable:</b> 2 m, 3-wire, PUR, halogen-free</li> <li><b>Application:</b> Drag chain operation, Zones with oils and lubricants, Robot, Drag chain operation</li> </ul>	YF8U13-020UA1M2A13	2096169
	<ul style="list-style-type: none"> <li><b>Description:</b> Sensor/actuator cable, unshielded</li> <li><b>Connection type head A:</b> Female connector, M8, 3-pin, straight, A-coded</li> <li><b>Connection type head B:</b> Male connector, M12, 3-pin, straight, A-coded</li> <li><b>Signal type:</b> Sensor/actuator cable</li> <li><b>Cable:</b> 5 m, 3-wire, PUR, halogen-free</li> <li><b>Application:</b> Drag chain operation, Zones with oils and lubricants, Robot, Drag chain operation</li> </ul>	YF8U13-050UA1M2A13	2096170
	<ul style="list-style-type: none"> <li><b>Description:</b> Sensor/actuator cable, unshielded</li> <li><b>Connection type head A:</b> Female connector, M8, 3-pin, straight, A-coded</li> <li><b>Connection type head B:</b> Male connector, M12, 3-pin, straight, A-coded</li> <li><b>Signal type:</b> Sensor/actuator cable</li> <li><b>Cable:</b> 2 m, 3-wire, PVC</li> <li><b>Application:</b> Uncontaminated zones, Zones with chemicals</li> </ul>	YF8U13-020VA1M2A13	2096605
	<ul style="list-style-type: none"> <li><b>Description:</b> Sensor/actuator cable, unshielded</li> <li><b>Connection type head A:</b> Female connector, M8, 3-pin, straight, A-coded</li> <li><b>Connection type head B:</b> Male connector, M12, 3-pin, straight, A-coded</li> <li><b>Signal type:</b> Sensor/actuator cable</li> <li><b>Cable:</b> 5 m, 3-wire, PVC</li> <li><b>Application:</b> Uncontaminated zones, Zones with chemicals</li> </ul>	YF8U13-050VA1M2A13	2096606
	<ul style="list-style-type: none"> <li><b>Description:</b> Sensor/actuator cable, unshielded</li> <li><b>Connection type head A:</b> Female connector, M8, 3-pin, angled, A-coded</li> <li><b>Connection type head B:</b> Male connector, M12, 3-pin, straight, A-coded</li> <li><b>Signal type:</b> Sensor/actuator cable</li> <li><b>Cable:</b> 2 m, 3-wire, PUR, halogen-free</li> <li><b>Application:</b> Drag chain operation, Zones with oils and lubricants, Robot, Drag chain operation</li> </ul>	YG8U13-020UA1M2A13	2095748
	<ul style="list-style-type: none"> <li><b>Description:</b> Sensor/actuator cable, unshielded</li> <li><b>Connection type head A:</b> Female connector, M8, 3-pin, straight, A-coded</li> <li><b>Connection type head B:</b> Male connector, M8, 3-pin, straight, A-coded</li> <li><b>Signal type:</b> Sensor/actuator cable</li> <li><b>Cable:</b> 2 m, 3-wire, PUR, halogen-free</li> <li><b>Application:</b> Drag chain operation, Zones with oils and lubricants, Robot, Drag chain operation</li> </ul>	YF8U13-020UA1M8U13	2096304
	<ul style="list-style-type: none"> <li><b>Description:</b> Sensor/actuator cable, unshielded</li> <li><b>Connection type head A:</b> Female connector, M8, 3-pin, straight, A-coded</li> <li><b>Connection type head B:</b> Male connector, M8, 3-pin, straight, A-coded</li> <li><b>Signal type:</b> Sensor/actuator cable</li> <li><b>Cable:</b> 5 m, 3-wire, PUR, halogen-free</li> <li><b>Application:</b> Drag chain operation, Zones with oils and lubricants, Robot, Drag chain operation</li> </ul>	YF8U13-050UA1M8U13	2096308
	<ul style="list-style-type: none"> <li><b>Description:</b> Sensor/actuator cable, unshielded</li> <li><b>Connection type head A:</b> Female connector, M8, 3-pin, angled, A-coded</li> <li><b>Connection type head B:</b> Male connector, M8, 3-pin, straight, A-coded</li> <li><b>Signal type:</b> Sensor/actuator cable</li> <li><b>Cable:</b> 2 m, 3-wire, PUR, halogen-free</li> <li><b>Application:</b> Drag chain operation, Zones with oils and lubricants, Robot, Drag chain operation</li> </ul>	YG8U13-020UA1M8U13	2107781
	<ul style="list-style-type: none"> <li><b>Description:</b> Sensor/actuator cable, unshielded</li> <li><b>Connection type head A:</b> Female connector, M8, 3-pin, angled, A-coded</li> <li><b>Connection type head B:</b> Male connector, M12, 3-pin, straight, A-coded</li> <li><b>Signal type:</b> Sensor/actuator cable</li> <li><b>Cable:</b> 5 m, 3-wire, PUR, halogen-free</li> <li><b>Application:</b> Drag chain operation, Zones with oils and lubricants, Robot, Drag chain operation</li> </ul>	YG8U13-050UA1M2A13	2122842
	<ul style="list-style-type: none"> <li><b>Description:</b> Sensor/actuator cable, unshielded</li> <li><b>Connection type head A:</b> Female connector, M8, 3-pin, straight, A-coded</li> <li><b>Connection type head B:</b> Male connector, M12, 3-pin, straight, A-coded</li> <li><b>Signal type:</b> Sensor/actuator cable</li> <li><b>Cable:</b> 3 m, 3-wire, PUR, halogen-free</li> </ul>	YF8U13-030UA1M2A13	2144589

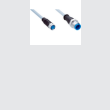
	Brief description	Type	part no.
	<ul style="list-style-type: none"> <li><b>Application:</b> Drag chain operation, Zones with oils and lubricants, Robot, Drag chain operation</li> <li><b>Description:</b> Sensor/actuator cable, unshielded</li> <li><b>Connection type head A:</b> Female connector, M8, 3-pin, angled, A-coded</li> <li><b>Connection type head B:</b> Flying leads</li> <li><b>Signal type:</b> Sensor/actuator cable</li> <li><b>Cable:</b> 0.6 m, 3-wire, PUR, halogen-free</li> <li><b>Application:</b> Drag chain operation, Zones with oils and lubricants, Robot, Drag chain operation</li> </ul>	YG8U13- C60UA1XLEAX	2145889
	<ul style="list-style-type: none"> <li><b>Description:</b> Sensor/actuator cable, unshielded</li> <li><b>Connection type head A:</b> Female connector, M8, 3-pin, angled, A-coded</li> <li><b>Connection type head B:</b> Flying leads</li> <li><b>Signal type:</b> Sensor/actuator cable</li> <li><b>Cable:</b> 3 m, 3-wire, PUR, halogen-free</li> <li><b>Application:</b> Drag chain operation, Zones with oils and lubricants, Robot, Drag chain operation</li> </ul>	YG8U13-030UA1XLEAX	2145891
	<ul style="list-style-type: none"> <li><b>Description:</b> Sensor/actuator cable, unshielded</li> <li><b>Connection type head A:</b> Female connector, M8, 3-pin, straight, A-coded</li> <li><b>Connection type head B:</b> Flying leads</li> <li><b>Signal type:</b> Sensor/actuator cable</li> <li><b>Cable:</b> 0.6 m, 3-wire, PVC</li> <li><b>Application:</b> Uncontaminated zones, Zones with chemicals</li> </ul>	YF8U13- C60VA1XLEAX	2146368
	<ul style="list-style-type: none"> <li><b>Description:</b> Sensor/actuator cable, unshielded</li> <li><b>Connection type head A:</b> Female connector, M8, 3-pin, straight, A-coded</li> <li><b>Connection type head B:</b> Male connector, M12, 3-pin, straight, A-coded</li> <li><b>Signal type:</b> Sensor/actuator cable</li> <li><b>Cable:</b> 1 m, 3-wire, PVC</li> <li><b>Application:</b> Uncontaminated zones, Zones with chemicals</li> </ul>	YF8U13-010VA1M2A13	2146381

## SICK AT A GLANCE

SICK is one of the leading manufacturers of intelligent sensors and sensor solutions for industrial applications. A unique range of products and services creates the perfect basis for controlling processes securely and efficiently, protecting individuals from accidents and preventing damage to the environment.

We have extensive experience in a wide range of industries and understand their processes and requirements. With intelligent sensors, we can deliver exactly what our customers need. In application centers in Europe, Asia and North America, system solutions are tested and optimized in accordance with customer specifications. All this makes us a reliable supplier and development partner.

Comprehensive services complete our offering: SICK LifeTime Services provide support throughout the machine life cycle and ensure safety and productivity.

For us, that is “Sensor Intelligence.”

## WORLDWIDE PRESENCE:

Contacts and other locations –[www.sick.com](http://www.sick.com)