



# WLD4FP-32162130A00

W4

PHOTOELECTRIC SENSORS

**SICK**  
Sensor Intelligence.



Illustration may differ

### Ordering information

Type	part no.
WLD4FP-32162130A00	1113194

Other models and accessories → [www.sick.com/W4](http://www.sick.com/W4)



### Detailed technical data

#### Features

<b>Functional principle</b>	Photoelectric retro-reflective sensor
<b>Functional principle detail</b>	With minimum distance to reflector (dual lens system)
<b>Sensing range</b>	
Sensing range min.	0 m
Sensing range max.	4.5 m
Maximum distance range from reflector to sensor (operating reserve 1)	0.015 m ... 4.5 m
Recommended distance range from reflector to sensor (operating reserve 3,75)	0.035 m ... 3.9 m
Reference reflector	Reflector P250
Recommended sensing range for the best performance	0.035 m ... 3.9 m
<b>Polarisation filter</b>	Yes
<b>Emitted beam</b>	
Light source	PinPoint LED
Type of light	Visible red light
Shape of light spot	Point-shaped
Light spot size (distance)	Ø 38 mm (1,000 mm)
Maximum dispersion of the emitted beam around the standardized transmission axis (squint angle)	< +/- 1.5° (at T <sub>U</sub> = +23 °C)

<b>Key LED figures</b>		
Normative reference		EN 62471:2008-09   IEC 62471:2006, modified
LED risk group marking		Free group
Wave length		635 nm
Average service life		100,000 h at T <sub>a</sub> = +25 °C
<b>Adjustment</b>		
Teach-in button		BluePilot For sensitivity adjustment
IO-Link		For configuring the sensor parameters and Smart Task functions
<b>Display</b>		
LED blue		BluePilot: Alignment aid
LED green		Operating indicator Static on: power on Flashing: IO-Link mode
LED yellow		Status of received light beam Static on: object not present Static off: object present Flashing: Below the 1.5 function reserve

### Safety-related parameters

<b>MTTF<sub>D</sub></b>	747 years
<b>DC<sub>avg</sub></b>	0 %
<b>T<sub>M</sub> (mission time)</b>	20 years

### Communication interface

<b>IO-Link</b>		✓, IO-Link V1.1
Data transmission rate		COM2 (38,4 kBaud)
Cycle time		2.3 ms
Process data length		16 Bit
Process data structure		Bit 0 = switching signal Q <sub>L1</sub> Bit 1 = switching signal Q <sub>L2</sub> Bit 2 ... 15 = Current receiver level (live)
VendorID		26
DeviceID HEX		0x800250
DeviceID DEC		8389200
Compatible master port type		A
SIO mode support		Yes

### Electronics

<b>Supply voltage U<sub>B</sub></b>	10 V DC ... 30 V DC <sup>1)</sup>
<b>Ripple</b>	≤ 5 V <sub>pp</sub>
<b>Usage category</b>	DC-12 (According to EN 60947-5-2) DC-13 (According to EN 60947-5-2)

<sup>1)</sup> Limit values.

<sup>2)</sup> Signal transit time with resistive load in switching mode.

<sup>3)</sup> With light/dark ratio 1:1.

<sup>4)</sup> This switching output must not be connected to another output.

<b>Current consumption</b>	≤ 20 mA, without load. At $U_B = 24\text{ V}$
<b>Protection class</b>	III
<b>Digital output</b>	
Number	2 (Complementary)
Type	Push-pull: PNP/NPN
Switching mode	Light/dark switching
Signal voltage PNP HIGH/LOW	Approx. $U_B - 2.5\text{ V} / 0\text{ V}$
Signal voltage NPN HIGH/LOW	Approx. $U_B / < 2.5\text{ V}$
Output current $I_{\max}$	≤ 100 mA
Circuit protection outputs	Reverse polarity protected
	Overcurrent protected
	Short-circuit protected
Response time	≤ 500 $\mu\text{s}$
Repeatability (response time)	150 $\mu\text{s}$ <sup>2)</sup>
Switching frequency	1,000 Hz <sup>3)</sup>
<b>Pin/Wire assignment</b>	
Function of pin 4/black (BK)	Digital output, light switching, object present → output $Q_{L1}$ LOW; IO-Link communication C <sup>4)</sup>
Function of pin 4/black (BK) – detail	The pin 4 function of the sensor can be configured Additional possible settings via IO-Link
Function of pin 2/white (WH)	Digital output, dark switching, object present → output $\bar{Q}_{L1}$ HIGH <sup>4)</sup>
Function of pin 2/white (WH) – detail	The pin 2 function of the sensor can be configured Additional possible settings via IO-Link

<sup>1)</sup> Limit values.

<sup>2)</sup> Signal transit time with resistive load in switching mode.

<sup>3)</sup> With light/dark ratio 1:1.

<sup>4)</sup> This switching output must not be connected to another output.

### Mechanics

<b>Housing</b>	Rectangular
<b>Design detail</b>	Flat
<b>Dimensions (W x H x D)</b>	16 mm x 40.1 mm x 12.1 mm
<b>Connection</b>	Cable with M8 male connector, 4-pin, 110 mm
<b>Connection detail</b>	
Deep-freeze property	Do not bend below 0 °C
Conductor size	0.14 mm <sup>2</sup>
Cable diameter	∅ 3.4 mm
Length of cable (L)	77 mm
<b>Material</b>	
Housing	Plastic, VISTAL®
Front screen	Plastic, PMMA
Cable	Plastic, PVC
Male connector	Plastic, VISTAL®
<b>Weight</b>	Approx. 30 g

<b>Maximum tightening torque of the fixing screws</b>	0.4 Nm
---	--------

## Ambient data

<b>Enclosure rating</b>	IP66 (EN 60529) IP67 (EN 60529)
<b>Ambient operating temperature</b>	-40 °C ... +60 °C
<b>Ambient temperature, storage</b>	-40 °C ... +75 °C
<b>Typ. Ambient light immunity</b>	Artificial light: ≤ 50,000 lx Sunlight: ≤ 50,000 lx
<b>Shock resistance</b>	30 g, 11 ms (3 positive and 3 negative shocks along X, Y, Z axes, 18 total shocks (EN60068-2-27))
<b>Vibration resistance</b>	10 Hz ... 1,000 Hz (Amplitude 1 mm, 3 x 30 min (EN60068-2-6))
<b>Air humidity</b>	35 % ... 95 %, relative humidity (no condensation)
<b>Electromagnetic compatibility (EMC)</b>	EN 60947-5-2
<b>Resistance to cleaning agent</b>	ECOLAB
<b>UL File No.</b>	NRKH.E181493 & NRKH7.E181493

## Smart Task

<b>Smart Task name</b>	Base logics
<b>Logic function</b>	Direct AND OR
<b>Timer function</b>	Deactivated Switch-on delay Off delay ON and OFF delay Impulse (one shot)
<b>Inverter</b>	Yes
<b>Switching frequency</b>	SIO Logic: 800 Hz <sup>1)</sup> IOL: 750 Hz <sup>2)</sup>
<b>Response time</b>	SIO Logic: 600 μs <sup>1)</sup> IOL: 650 μs <sup>2)</sup>
<b>Repeatability</b>	SIO Logic: 200 μs <sup>1)</sup> IOL: 250 μs <sup>2)</sup>
<b>Switching signal</b>	
Switching signal Q <sub>L1</sub>	Switching output
Switching signal $\bar{Q}$ <sub>L1</sub>	Switching output

<sup>1)</sup> Use of Smart Task functions without IO-Link communication (SIO mode).

<sup>2)</sup> Use of Smart Task functions with IO-Link communication function.

## Diagnosis

<b>Device temperature</b>	
Measuring range	Very cold, cold, moderate, warm, hot
<b>Device status</b>	Yes
<b>Detailed device status</b>	Yes
<b>Operating hour counter</b>	Yes
<b>Operating hours counter with reset function</b>	Yes

<b>Quality of teach</b>	Yes
<b>Quality of run</b>	Yes, Contamination display

### Certificates

<b>EU declaration of conformity</b>	✓
<b>UK declaration of conformity</b>	✓
<b>ACMA declaration of conformity</b>	✓
<b>Moroccan declaration of conformity</b>	✓
<b>China RoHS</b>	✓
<b>ECOLAB certificate</b>	✓
<b>cULus certificate</b>	✓
<b>IO-Link certificate</b>	✓
<b>Information according to Art. 3 of Data Act (Regulation EU 2023/2854)</b>	✓

### Classifications

<b>ECLASS 5.0</b>	27270902
<b>ECLASS 5.1.4</b>	27270902
<b>ECLASS 6.0</b>	27270902
<b>ECLASS 6.2</b>	27270902
<b>ECLASS 7.0</b>	27270902
<b>ECLASS 8.0</b>	27270902
<b>ECLASS 8.1</b>	27270902
<b>ECLASS 9.0</b>	27270902
<b>ECLASS 10.0</b>	27270902
<b>ECLASS 11.0</b>	27270902
<b>ECLASS 12.0</b>	27270904
<b>ETIM 5.0</b>	EC002717
<b>ETIM 6.0</b>	EC002717
<b>ETIM 7.0</b>	EC002717
<b>ETIM 8.0</b>	EC002717
<b>UNSPSC 16.0901</b>	39121528

### display and adjustment elements

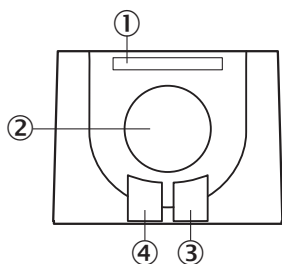

① LED blue

- ② Teach-in button
- ③ LED yellow
- ④ LED green

Connection type Male connector M8, 4-pin

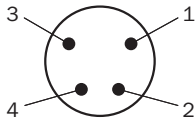

Connection diagram Cd-490

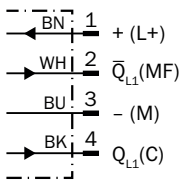

Truth table Push-pull: PNP/NPN - light switching Q

	Light switching Q (normally closed (upper switch), normally open (lower switch))	
	Object not present → Output HIGH	Object present → Output LOW
Light receive	✔	✘
Light receive indicator	☀	✘
Load resistance to L+	✘	⚡
Load resistance to M	⚡	✘
	<p>Diagram showing the sensor without an object. Light from the emitter passes through the lens and is received by the receiver. The output switch Q is in its normally closed state. The internal circuit shows Q connected to + (L+) and - (M).</p>	<p>Diagram showing the sensor with an object. The object blocks the light path. The output switch Q is in its normally open state. The internal circuit shows Q connected to + (L+) and - (M).</p>

### Truth table Push-pull: PNP/NPN – dark switching $\bar{Q}$

	Dark switching $\bar{Q}$ (normally open (upper switch), normally closed (lower switch))	
	Object not present → Output LOW	Object present → Output HIGH
Light receive	✓	✗
Light receive indicator	☀	✗
Load resistance to L+	⚡	✗
Load resistance to M	✗	⚡

### Characteristic curve Fine triple reflectors

Operating reserve

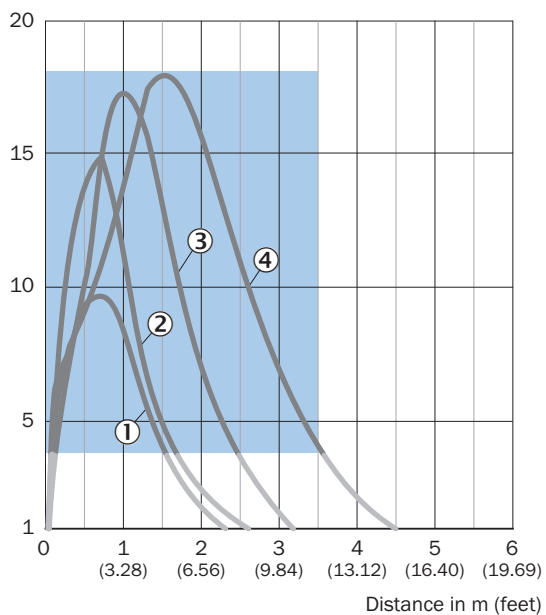

Recommended sensing range for the best performance

- ① PL10FH reflector
- ② PL10F reflector
- ③ Reflector PL20F
- ④ Reflector P250F

### Characteristic curve Standard reflectors

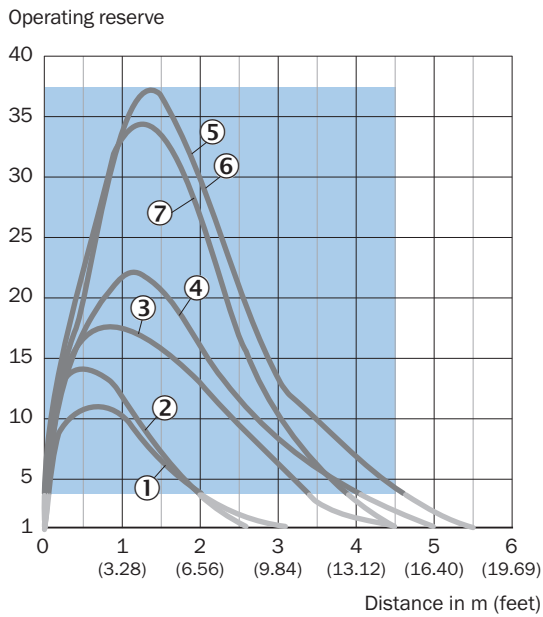

- Recommended sensing range for the best performance
- ① Reflector PL22
- ② Reflector PL20A
- ③ Reflector PL30A
- ④ Reflector PL40A
- ⑤ Reflector PL80A
- ⑥ Reflector C110A
- ⑦ Reflector P250

### Characteristic curve Chemical-resistant reflectors

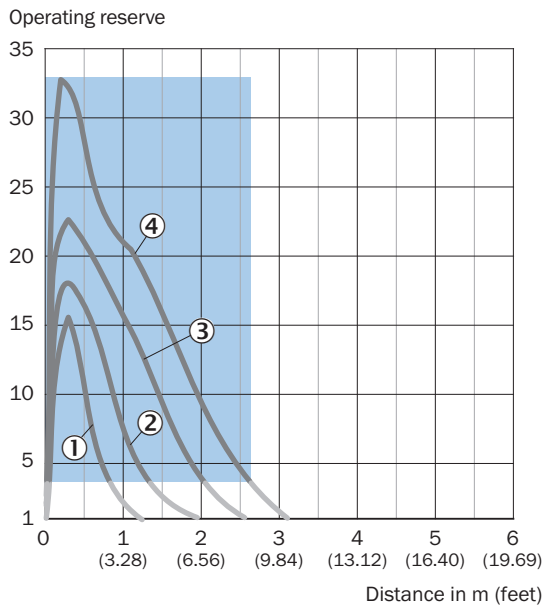

- Recommended sensing range for the best performance
- ① PL10F CHEM reflector

- ② Reflector PL20 CHEM
- ③ Reflector P250 CHEM
- ④ Reflector P250H

### Characteristic curve Reflective tape

Operating reserve

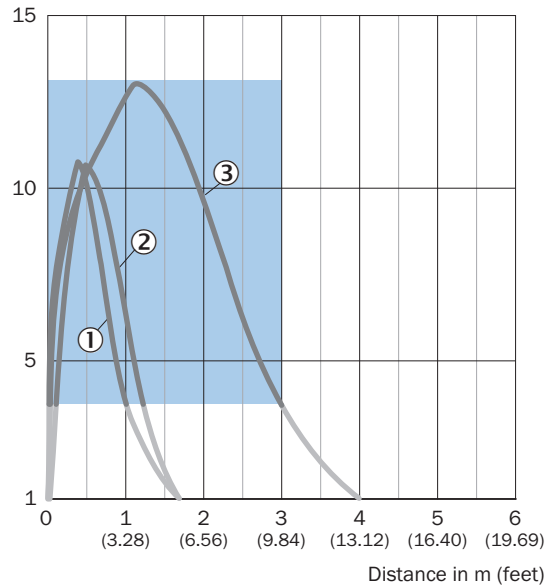

- Recommended sensing range for the best performance
- ① Reflective tape REF-DG
- ② reflective tape REF-IRF-56
- ③ Reflective tape REF-AC1000

### Light spot size

Dimensions in mm (inch)

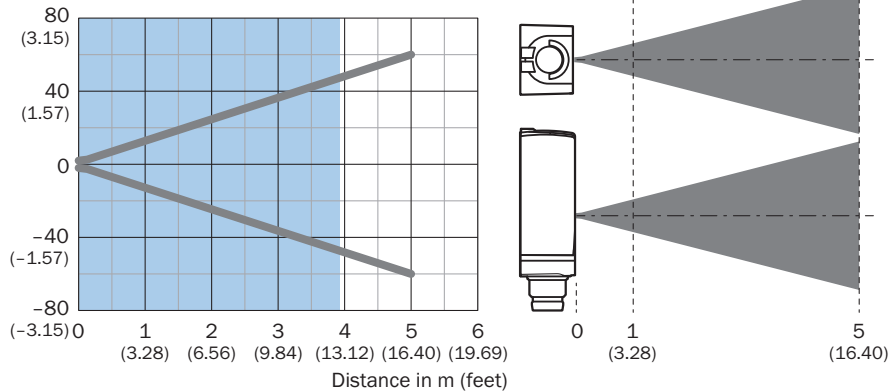

- Recommended sensing range for the best performance

### Sensing range diagram Chemical-resistant reflectors

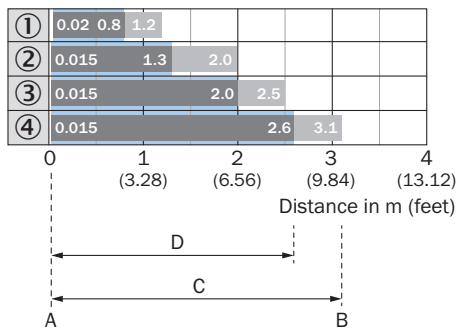

A = Sensing range min. in m  
 B = Sensing range max. in m  
 C = Maximum distance range from reflector to sensor (operating reserve 1)  
 D = Recommended distance range from reflector to sensor (operating reserve 3.75)

  Recommended sensing range for the best performance

- ① PL10F CHEM reflector
- ② Reflector PL20 CHEM
- ③ Reflector P250 CHEM
- ④ Reflector P250H

### Sensing range diagram Reflective tape

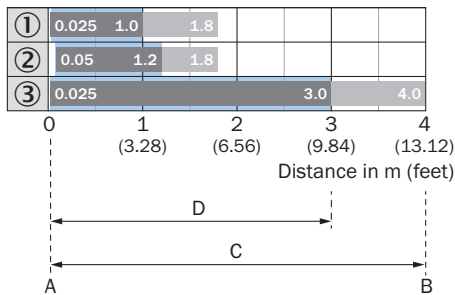

A = Sensing range min. in m  
 B = Sensing range max. in m  
 C = Maximum distance range from reflector to sensor (operating reserve 1)  
 D = Recommended distance range from reflector to sensor (operating reserve 3.75)

  Recommended sensing range for the best performance

- ① Reflective tape REF-DG (50 x 50 mm)
- ② reflective tape REF-IRF-56
- ③ Reflective tape REF-AC1000

### Sensing range diagram Fine triple reflectors



- A = Sensing range min. in m
- B = Sensing range max. in m
- C = Maximum distance range from reflector to sensor (operating reserve 1)
- D = Recommended distance range from reflector to sensor (operating reserve 3.75)

Recommended sensing range for the best performance

- ① PL10FH reflector
- ② PL10F reflector
- ③ Reflector PL20F
- ④ Reflector P250F

### Sensing range diagram Standard reflectors



- A = Sensing range min. in m
- B = Sensing range max. in m
- C = Maximum distance range from reflector to sensor (operating reserve 1)
- D = Recommended distance range from reflector to sensor (operating reserve 3.75)

Recommended sensing range for the best performance

- ① Reflector PL22
- ② Reflector PL20A
- ③ Reflector PL30A
- ④ Reflector PL40A
- ⑤ Reflector PL80A
- ⑥ Reflector C110A
- ⑦ Reflector P250

Dimensional drawing

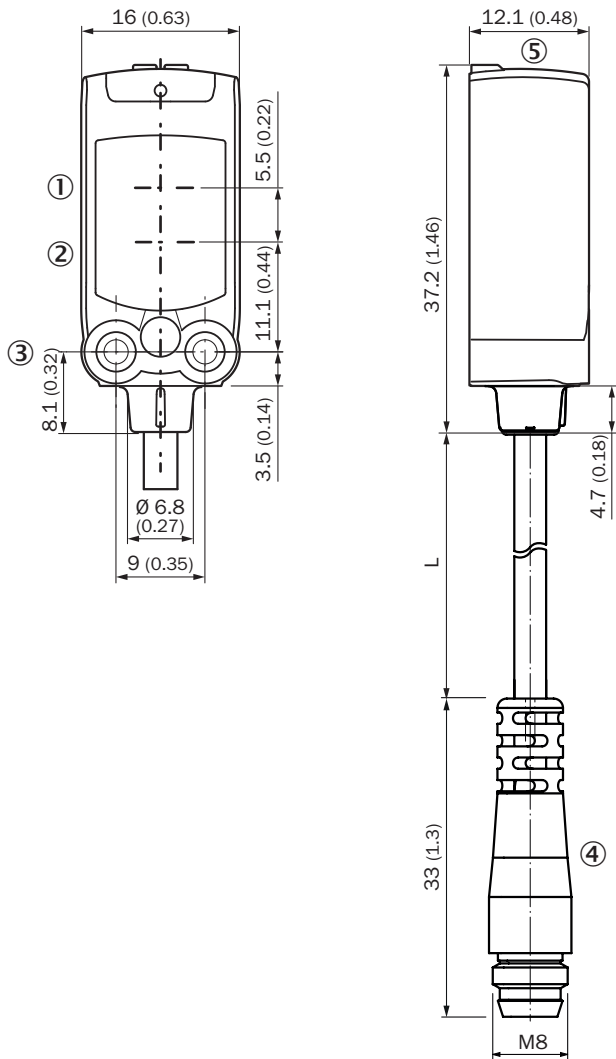





Dimensions in mm (inch)







For length of cable (L), see technical data

- ① Center of optical axis, sender
- ② Center of optical axis, receiver
- ③ M3 mounting hole
- ④ cable with connector M8
- ⑤ display and adjustment elements

### Recommended accessories

Other models and accessories → [www.sick.com/W4](http://www.sick.com/W4)

	Brief description	Type	part no.
<b>Mounting systems</b>			
	<ul style="list-style-type: none"> <li><b>Description:</b> Mounting bracket for wall mounting</li> <li><b>Material:</b> Stainless steel</li> <li><b>Details:</b> Stainless steel 1.4571</li> <li><b>Items supplied:</b> Mounting hardware included</li> <li><b>Suitable for:</b> W4S, W4F, W4S</li> </ul>	BEF-W4-A	2051628
	<ul style="list-style-type: none"> <li><b>Description:</b> Mounting bracket for floor mounting</li> <li><b>Material:</b> Stainless steel</li> <li><b>Details:</b> Stainless steel 1.4571</li> <li><b>Items supplied:</b> Mounting hardware included</li> <li><b>Suitable for:</b> W4S, W4F, W4S</li> </ul>	BEF-W4-B	2051630
	<ul style="list-style-type: none"> <li><b>Description:</b> Plate N08 for universal clamp bracket</li> <li><b>Material:</b> Steel, zinc diecast</li> <li><b>Details:</b> Zinc plated steel (sheet), Zinc die cast (clamping bracket)</li> <li><b>Items supplied:</b> Universal clamp (5322626), mounting hardware</li> <li><b>Usable for:</b> W100, W150, W4S, W4F, W8, W9-3, W8G, W8 Laser, W8 Inox, G6, W100 Laser, W100-2, W10, G6 Inox, RAY10, W4SLG-3, W9, GR18, MultiPulse, Reflex Array, MultiLine, LUT3, KT5, KT8, KT10, CS8</li> </ul>	BEF-KHS-N08	2051607
<b>reflectors and optics</b>			
	<ul style="list-style-type: none"> <li><b>Description:</b> Fine triple reflector, screw connection, suitable for laser sensors</li> <li><b>Dimensions:</b> 20 mm 32 mm</li> <li><b>Ambient operating temperature:</b> -30 °C ... +65 °C</li> </ul>	PL10F	5311210

	Brief description	Type	part no.
connectors and cables			
	<ul style="list-style-type: none"> <li><b>Description:</b> Sensor/actuator cable, unshielded</li> <li><b>Connection type head A:</b> Female connector, M12, 4-pin, straight, A-coded</li> <li><b>Connection type head B:</b> Flying leads</li> <li><b>Signal type:</b> Sensor/actuator cable</li> <li><b>Cable:</b> 5 m, 4-wire, PVC</li> <li><b>Application:</b> Uncontaminated zones, Zones with chemicals</li> </ul>	YF2A14-050VB3XLEAX	2096235
	<ul style="list-style-type: none"> <li><b>Description:</b> Sensor/actuator cable, unshielded</li> <li><b>Connection type head A:</b> Female connector, M12, 4-pin, straight, A-coded</li> <li><b>Connection type head B:</b> Flying leads</li> <li><b>Signal type:</b> Sensor/actuator cable</li> <li><b>Cable:</b> 5 m, 4-wire, PUR, halogen-free</li> <li><b>Application:</b> Drag chain operation, Zones with oils and lubricants, Robot, Drag chain operation</li> </ul>	YF2A14-050UB3XLEAX	2095608
	<ul style="list-style-type: none"> <li><b>Description:</b> Unshielded</li> <li><b>Connection type head A:</b> Male connector, M12, 4-pin, straight, A-coded</li> <li><b>Connection systems:</b> Screw-type terminals</li> <li><b>Permitted cross-section:</b> ≤ 0.75 mm<sup>2</sup></li> </ul>	STE-1204-G	6009932
	<ul style="list-style-type: none"> <li><b>Description:</b> Sensor/actuator cable, unshielded</li> <li><b>Connection type head A:</b> Female connector, M8, 4-pin, straight, A-coded</li> <li><b>Connection type head B:</b> Flying leads</li> <li><b>Signal type:</b> Sensor/actuator cable</li> <li><b>Cable:</b> 5 m, 4-wire, PVC</li> <li><b>Application:</b> Uncontaminated zones, Zones with chemicals</li> </ul>	YF8U14-050VA3XLEAX	2095889
	<ul style="list-style-type: none"> <li><b>Description:</b> Unshielded</li> <li><b>Connection type head A:</b> Male connector, M8, 4-pin, straight, A-coded</li> <li><b>Connection systems:</b> Screw-type terminals</li> <li><b>Permitted cross-section:</b> 0.14 mm<sup>2</sup> ... 0.5 mm<sup>2</sup></li> </ul>	STE-0804-G	6037323
	<ul style="list-style-type: none"> <li><b>Description:</b> Sensor/actuator cable, unshielded</li> <li><b>Connection type head A:</b> Female connector, M8, 4-pin, straight, A-coded</li> <li><b>Connection type head B:</b> Flying leads</li> <li><b>Signal type:</b> Sensor/actuator cable</li> <li><b>Cable:</b> 5 m, 4-wire, PUR, halogen-free</li> <li><b>Application:</b> Drag chain operation, Zones with oils and lubricants, Robot, Drag chain operation</li> </ul>	YF8U14-050UA3XLEAX	2094792

## SICK AT A GLANCE

SICK is one of the leading manufacturers of intelligent sensors and sensor solutions for industrial applications. A unique range of products and services creates the perfect basis for controlling processes securely and efficiently, protecting individuals from accidents and preventing damage to the environment.

We have extensive experience in a wide range of industries and understand their processes and requirements. With intelligent sensors, we can deliver exactly what our customers need. In application centers in Europe, Asia and North America, system solutions are tested and optimized in accordance with customer specifications. All this makes us a reliable supplier and development partner.

Comprehensive services complete our offering: SICK LifeTime Services provide support throughout the machine life cycle and ensure safety and productivity.

For us, that is “Sensor Intelligence.”

## WORLDWIDE PRESENCE:

Contacts and other locations –[www.sick.com](http://www.sick.com)