



# MLG30A-0420R50501

MLG-2

AUTOMATION LIGHT GRIDS

**SICK**  
Sensor Intelligence.



Illustration may differ

### Ordering information

Type	part no.
MLG30A-0420R50501	1110459

Other models and accessories → [www.sick.com/MLG-2](http://www.sick.com/MLG-2)



### Detailed technical data

#### Features

<b>Device version</b>	Pro - Extended functionality										
<b>Sensor principle</b>	Sender/receiver										
<b>Minimum detectable object (MDO)</b>	30 mm <sup>1)</sup> 34 mm <sup>2)</sup> <sup>3)</sup>										
<b>Beam separation</b>	30 mm										
<b>Type of synchronization</b>	Cable										
<b>Number of beams</b>	15										
<b>Detection height</b>	420 mm										
<b>Software features (default)</b>	<table border="0"> <tr> <td>Q<sub>1</sub></td> <td>Presence detection</td> </tr> <tr> <td>Q<sub>2</sub> / IN</td> <td>Teach input</td> </tr> <tr> <td>Q<sub>3</sub></td> <td>Presence detection</td> </tr> <tr> <td>Q<sub>4</sub> / IN2</td> <td>Presence detection</td> </tr> <tr> <td>Teach</td> <td>Standard mode</td> </tr> </table>	Q <sub>1</sub>	Presence detection	Q <sub>2</sub> / IN	Teach input	Q <sub>3</sub>	Presence detection	Q <sub>4</sub> / IN2	Presence detection	Teach	Standard mode
Q <sub>1</sub>	Presence detection										
Q <sub>2</sub> / IN	Teach input										
Q <sub>3</sub>	Presence detection										
Q <sub>4</sub> / IN2	Presence detection										
Teach	Standard mode										
<b>Operating mode</b>	<table border="0"> <tr> <td>Standard</td> <td>✓</td> </tr> <tr> <td>Transparent</td> <td>✓</td> </tr> </table>	Standard	✓	Transparent	✓						
Standard	✓										
Transparent	✓										

<sup>1)</sup> MDO min. detectable object at high measurement accuracy.

<sup>2)</sup> MDO min. detectable object for standard measurement accuracy.

<sup>3)</sup> Depending on beam separation without cross beam setting.

Dust- and sunlight-resistant	✓
<b>Function</b>	
Cross beam	✓
Beam blanking	✓
High measurement accuracy	✓
<b>Applications</b>	
Switching output	Object detection/object width Object recognition Height classification Hole detection/hole size Outside/inside dimension Object position Hole position Zone definition
Data interface	Object detection Hole detection Object height measurement Measurement of the outside dimension Measurement of the inside dimension Measurement of the object position Measurement of the hole position
<b>Included with delivery</b>	1 × sender (in IP69K protective pipes) 1 × receiver (in IP69K protective pipes) 1 × IP69K mounting instructions 1 × Quick Start Guide

<sup>1)</sup> MDO min. detectable object at high measurement accuracy.

<sup>2)</sup> MDO min. detectable object for standard measurement accuracy.

<sup>3)</sup> Depending on beam separation without cross beam setting.

## Mechanics/electronics

<b>Light source</b>	LED, Infrared light
<b>Wave length</b>	850 nm
<b>Supply voltage <math>V_s</math></b>	DC 19.2 V ... 28.8 V <sup>1)</sup>
<b>Power consumption sender</b>	55.75 mA <sup>2)</sup>
<b>Power consumption receiver</b>	123 mA <sup>2)</sup>
<b>Ripple</b>	< 5 V <sub>pp</sub>
<b>Output current <math>I_{max}</math></b>	100 mA
<b>Output load, capacitive</b>	100 nF
<b>Output load, Inductive</b>	1 H
<b>Initialization time</b>	< 1 s
<b>Switching output</b>	Push-pull: PNP/NPN
<b>Connection type</b>	Plug, M12, 5-pin, 0.39 m Male connector M12, 8-pin, 0.39 m
<b>Housing material</b>	Aluminum (light grid) PMMA Plexiglas XT Food Contact DoC (protective pipe) Polypropylene, stainless steel 1.4404 (cable) VA 1.4305 (pressure compensation element) Stainless steel 1.4404 (end caps)

<sup>1)</sup> Without load.

<sup>2)</sup> Without load with 24 V.

<sup>3)</sup> Operating in outdoor condition only with a external protection housing.

	Stainless steel V4A 1.4404 DIN EN 1672-2 (cable gland)
<b>Display</b>	LED
<b>Enclosure rating</b>	IP69K 3)
<b>Circuit protection</b>	U <sub>V</sub> connections, reverse polarity protected Output Q short-circuit protected Interference pulse suppression
<b>Protection class</b>	III
<b>Weight</b>	1.46 kg
<b>Option</b>	Protective housing IP69K
<b>UL File No.</b>	NRKH.E181493

1) Without load.

2) Without load with 24 V.

3) Operating in outdoor condition only with a external protection housing.

### Performance

<b>Maximum range</b>	5.25 m <sup>1)</sup>
<b>Minimum range</b>	≥ 0 m
<b>Operating range</b>	3.75 m
<b>Response time</b>	3.6 ms <sup>2)</sup>

1) No reserve for environmental issue and deterioration of the diode.

2) Without high speed.

### Interfaces

<b>IO-Link</b>	✓ , IO-Link V1.1
Data transmission rate	230,4 kbit/s (COM3)
Maximum cable length	20 m
Cycle time	2.3 ms
VendorID	26
DeviceID HEX	800068
DeviceID DEC	8388712
Process data length	32 Byte (TYPE_2_V) <sup>1)</sup>
<b>Inputs/outputs</b>	4 x Q (IO-Link)
<b>Digital output</b>	Q <sub>1</sub> ... Q <sub>4</sub>
Number	4
<b>Digital input</b>	In <sub>1</sub> , In <sub>2</sub>
Number	2

1) For an IO-Link master with V1.0, reverts to interleaved mode (consisting of TYPE\_1\_1 (ProcessData) and TYPE\_1\_2 (on-request data)).

### Ambient data

<b>Shock resistance</b>	Continuous shocks 10 g, 16 ms, 1000 shocks Single shocks 15 g, 11 ms 3 per axle
<b>Vibration resistance</b>	Sinusoidal oscillation 10-150 Hz 5 g
<b>EMC</b>	EN 60947-5-2

1) Outdoor mode.

2) Light resistance indirect.

<b>Ambient light immunity</b>	Direct: 150,000 lx <sup>1)</sup> Indirect: 200,000 lx <sup>2)</sup>
<b>Ambient operating temperature</b>	-20 °C ... +55 °C
<b>Ambient temperature, storage</b>	-40 °C ... +70 °C

<sup>1)</sup> Outdoor mode.

<sup>2)</sup> Light resistance indirect.

## Smart Task

<b>Smart Task name</b>	Base logics
------------------------	-------------

## Certificates

<b>EU declaration of conformity</b>	✓
<b>UK declaration of conformity</b>	✓
<b>ACMA declaration of conformity</b>	✓
<b>Moroccan declaration of conformity</b>	✓
<b>cULus certificate</b>	✓
<b>IO-Link certificate</b>	✓
<b>Photobiological safety (IEC EN 62471)</b>	✓

## Classifications

<b>ECLASS 5.0</b>	27270910
<b>ECLASS 5.1.4</b>	27270910
<b>ECLASS 6.0</b>	27270910
<b>ECLASS 6.2</b>	27270910
<b>ECLASS 7.0</b>	27270910
<b>ECLASS 8.0</b>	27270910
<b>ECLASS 8.1</b>	27270910
<b>ECLASS 9.0</b>	27270910
<b>ECLASS 10.0</b>	27270910
<b>ECLASS 11.0</b>	27270910
<b>ECLASS 12.0</b>	27270910
<b>ETIM 5.0</b>	EC002549
<b>ETIM 6.0</b>	EC002549
<b>ETIM 7.0</b>	EC002549
<b>ETIM 8.0</b>	EC002549
<b>UNSPSC 16.0901</b>	39121528

### Dimensional drawing

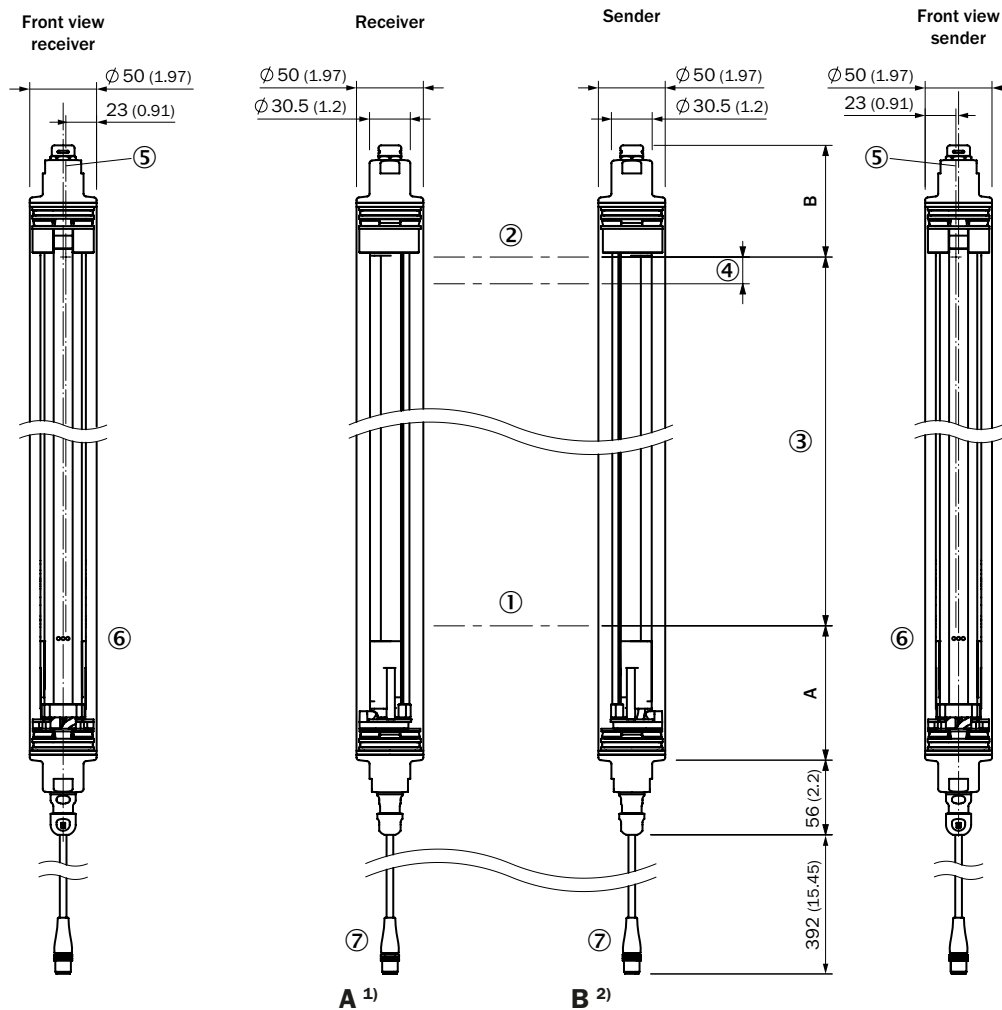

Beam separation	Receiver	Sender
Beam separation 2.5 mm	94.25 (3.71)	84.7 (3.33)
Beam separation 5 mm	95.5 (3.76)	83.6 (3.29)
Beam separation 10 mm	100.5 (3.96)	83.6 (3.29)
Beam separation 20 mm	100.5 (3.96)/110.5 (4.35) <sup>3)</sup>	83.6 (3.29)
Beam separation 25 mm	115.5 (4.55)	83.6 (3.29)
Beam separation 30 mm	120.5 (4.74)	83.6 (3.29)
Beam separation 50 mm	140.5 (5.53)	83.6 (3.29)

<sup>1)</sup> Distance: MLG-2 edge - first beam

<sup>2)</sup> Distance: MLG-2 edge - last beam

<sup>3)</sup> MLG20x-xx40: 100.5 mm

MLG20x-xx80: 110.5 mm

#### Dimensions in mm (inch)

- ① First beam
- ② last beam
- ③ detection height (see technical data)
- ④ Beam separation
- ⑤ Optical axis
- ⑥ status indicator: green, yellow, red LEDs
- ⑦ Connection

Connection type and diagram M12 male connector, 5/8-pin, switching outputs Q | YF2AP8-xxxPA4XLEAX (IP69K connecting cable)

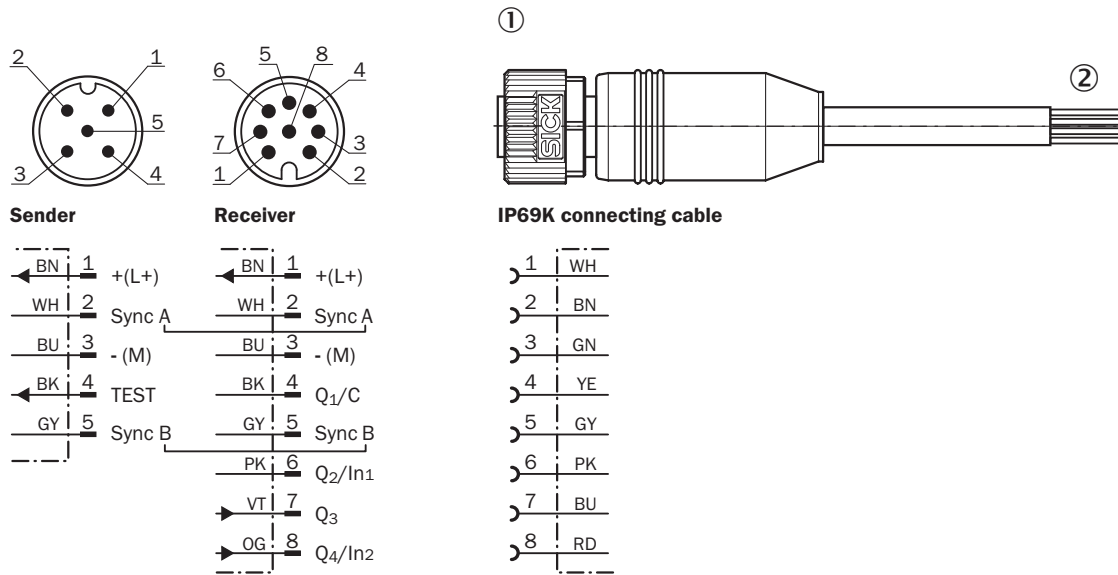

① Valid for: YF2AP8-250PA4XLEAX (2116447), YF2AP8-020PA4XLEAX (2111888)

② For 8-pin sensor-actuator cables, the wire colors are not standardized. Therefore, please observe the pin assignment of the sensor and the cable in the respective data sheet.

### Pinouts



- ① Connection cable receiver (2096010)
- ② T-junctions
- ③ Connection cable (6020664)

### Adjustments



- ① status indicator: green, yellow, red LEDs

Connection diagram T-splitter, IO-Link Master











Connection diagram T-splitter, PLC

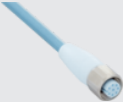
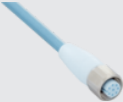

### Recommended accessories

Other models and accessories → [www.sick.com/MLG-2](http://www.sick.com/MLG-2)

	Brief description	Type	part no.
connectors and cables			
	<ul style="list-style-type: none"> <li><b>Description:</b> Unshielded</li> <li><b>Connection type head A:</b> Female connector, M12, 5-pin, A-coded</li> <li><b>Connection type head B:</b> Female connector, M12, 8-pin, A-coded</li> <li><b>Connection type head C:</b> Male connector, M12, 8-pin, A-coded</li> <li><b>Note:</b> For connecting of a PLC</li> </ul>	SBO-02F12-SM1	6053172
	<ul style="list-style-type: none"> <li><b>Description:</b> Sensor/actuator cable, special color code, shielded</li> <li><b>Connection type head A:</b> Female connector, M12, 8-pin, straight</li> <li><b>Connection type head B:</b> Flying leads</li> <li><b>Signal type:</b> Sensor/actuator cable</li> <li><b>Cable:</b> 5 m, 8-wire, PVC</li> <li><b>Connection systems:</b> Flying leads</li> <li><b>Application:</b> Uncontaminated zones, Zones with chemicals</li> </ul>	DOL-1208-G05MF	6020664
	<ul style="list-style-type: none"> <li><b>Description:</b> Sensor/actuator cable, unshielded</li> <li><b>Connection type head A:</b> Female connector, M12, 5-pin, straight, A-coded</li> <li><b>Connection type head B:</b> Male connector, M12, 5-pin, straight, A-coded</li> <li><b>Signal type:</b> Sensor/actuator cable</li> <li><b>Cable:</b> 5 m, 5-wire, PUR, halogen-free</li> <li><b>Application:</b> Drag chain operation, Zones with oils and lubricants, Robot, Drag chain operation</li> </ul>	YF2A15-050UB5M2A15	2096010
	<ul style="list-style-type: none"> <li><b>Connection type head A:</b> Female connector, M12, 8-pin, straight, A-coded</li> <li><b>Connection type head B:</b> Flying leads</li> <li><b>Signal type:</b> Sensor/actuator cable</li> <li><b>Cable:</b> 2 m, 8-wire</li> <li><b>Description:</b> Sensor/actuator cable, unshielded</li> <li><b>Application:</b> Drag chain operation, Robot</li> </ul>	YF2AP8-020PA4XLEAX	2111888
	<ul style="list-style-type: none"> <li><b>Connection type head A:</b> Female connector, M12, 8-pin, straight, A-coded</li> <li><b>Connection type head B:</b> Flying leads</li> <li><b>Signal type:</b> Sensor/actuator cable</li> <li><b>Cable:</b> 25 m, 8-wire</li> <li><b>Description:</b> Sensor/actuator cable, unshielded</li> <li><b>Application:</b> Drag chain operation, Robot</li> </ul>	YF2AP8-250PA4XLEAX	2116447
	<ul style="list-style-type: none"> <li><b>Connection type head A:</b> Female connector, M12, 8-pin, straight, A-coded</li> <li><b>Connection type head B:</b> Flying leads</li> <li><b>Signal type:</b> Sensor/actuator cable</li> <li><b>Cable:</b> 10 m, 8-wire</li> <li><b>Description:</b> Sensor/actuator cable, unshielded</li> <li><b>Application:</b> Drag chain operation, Robot</li> </ul>	YF2AP8-100PA4XLEAX	2146858
	<ul style="list-style-type: none"> <li><b>Connection type head A:</b> Female connector, M12, 8-pin, straight, A-coded</li> <li><b>Connection type head B:</b> Flying leads</li> <li><b>Signal type:</b> Sensor/actuator cable</li> <li><b>Cable:</b> 20 m, 8-wire</li> <li><b>Description:</b> Sensor/actuator cable, unshielded</li> <li><b>Application:</b> Drag chain operation, Robot</li> </ul>	YF2AP8-200PA4XLEAX	2146859
	<ul style="list-style-type: none"> <li><b>Connection type head A:</b> Female connector, M12, 8-pin, straight, A-coded</li> <li><b>Connection type head B:</b> Flying leads</li> <li><b>Signal type:</b> Sensor/actuator cable</li> <li><b>Cable:</b> 40 m, 8-wire</li> <li><b>Description:</b> Sensor/actuator cable, unshielded</li> <li><b>Application:</b> Drag chain operation, Robot</li> </ul>	YF2AP8-400PA4XLEAX	2146860

	Brief description	Type	part no.
network devices			
		SIG350-0004AP100	6076871
		SIG350-0006AP100	6076924
		SIG350-0005AP100	6076923
Mounting systems			
	<ul style="list-style-type: none"> <li>• <b>Description:</b> Stainless steel bracket, rotatable</li> <li>• <b>Material:</b> Stainless steel</li> <li>• <b>Details:</b> Stainless steel 1.4350, stainless steel 1.4301</li> <li>• <b>Packing unit:</b> 4 pieces</li> </ul>	BEF-2SMMEAES4	2023708

## SICK AT A GLANCE

SICK is one of the leading manufacturers of intelligent sensors and sensor solutions for industrial applications. A unique range of products and services creates the perfect basis for controlling processes securely and efficiently, protecting individuals from accidents and preventing damage to the environment.

We have extensive experience in a wide range of industries and understand their processes and requirements. With intelligent sensors, we can deliver exactly what our customers need. In application centers in Europe, Asia and North America, system solutions are tested and optimized in accordance with customer specifications. All this makes us a reliable supplier and development partner.

Comprehensive services complete our offering: SICK LifeTime Services provide support throughout the machine life cycle and ensure safety and productivity.

For us, that is “Sensor Intelligence.”

## WORLDWIDE PRESENCE:

Contacts and other locations –[www.sick.com](http://www.sick.com)