



MICS3-CCAZ90AA1P01

microScan3

SAFETY LASER SCANNERS

SICK
Sensor Intelligence.



Illustration may differ

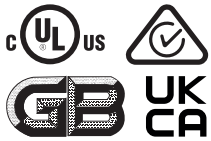

Ordering information

| Type | part no. |
|--------------------|----------|
| MICS3-CCAZ90AA1P01 | 1110037 |

Other models and accessories → www.sick.com/microScan3

Detailed technical data

Features

| | |
|--|---|
| Product version | microScan3 Pro I/O - EFI-pro |
| Model | Sensor including system plug (pre-mounted on the underside) |
| Application | Indoor |
| Protective field range | 9 m |
| Warning field range | 64 m |
| Collision protection field range | 19 m (on reference target) |
| Number of simultaneously monitored fields | ≤ 4 ¹⁾ |
| Number of fields | 128 |
| Number of monitoring cases | 128 |
| Scanning angle | 275° |
| Resolution (can be configured) | 30 mm 40 mm 50 mm 60 mm 70 mm 150 mm 200 mm |
| Angular resolution | 0.1° |
| Response time | 90 ms |
| Protective field supplement | 100 mm |

¹⁾ Protection, warning or contour detection fields.

Safety-related parameters

| | |
|-------------------------------|---------------------------|
| Type | Type 3 (IEC 61496) |
| Safety integrity level | SIL 2 (IEC 61508) |
| Category | Category 3 (EN ISO 13849) |

| | |
|---|---|
| Performance level | PL d (EN ISO 13849) |
| PFH_D (mean probability of a dangerous failure per hour) | 8.0 x 10 ⁻⁸ |
| T_M (mission time) | 20 years (EN ISO 13849) |
| Safe state in the event of a fault | At least one OSSD is in the OFF state. The safety outputs via the network are logic 0. |

Functions

| | |
|---|--------------|
| Restart interlock | ✓ |
| External device monitoring (EDM) | ✓ |
| Multiple sampling | ✓ |
| Monitoring case switching | ✓ |
| Simultaneous monitoring | ✓ |
| Static protective field switching | ✓ |
| Collision protection field | ✓ |
| Safe contour detection | ✓ |
| Contour as a reference | ✓ |
| Integrated configuration memory | ✓ |
| Measured data output | Via Ethernet |
| Safe SICK device communication via EFI-pro | ✓ |

Interfaces

| | |
|--|---|
| Connection type | |
| Voltage supply | 1 x male connector, M12, 4-pin, A-coded |
| Local inputs and outputs (I/O) | 2 x female connector, M12, 17-pin, A-coded |
| Dynamic switching signals | 2 x female connector, M12, 8-pin, A-coded |
| Fieldbus, industrial network | 2 x M12 female connectors, 4-pin, D-coded |
| Outputs | |
| OSSD pairs | 4 |
| Safety outputs via network | 4 |
| Universal outputs | 4 ¹⁾ |
| Inputs | |
| Universal inputs | 16 ¹⁾ |
| Dynamic switching signals | 2 |
| Static control inputs | 8 |
| Configuration method | PC with Safety Designer (Configuration and Diagnostic Software) |
| Configuration and diagnostics interface | USB 2.0, Mini-USB, Ethernet |
| Data interface | |
| Services | EtherNet/IP™ CIP Safety™ |
| | CoLa 2 (configuration and diagnostics using Safety Designer) |
| | Data output |
| | DHCP |

¹⁾ Freely configurable.

| | |
|-------------------------------------|-------------------------------------|
| | SNMP |
| | SNTP (client and server) |
| Fieldbus, industrial network | EFI-pro |
| RPI (requested packet interval) | 5 ms ... 1,000 ms, multiple of 5 ms |
| Display elements | Graphic color display, LEDs |

¹⁾ Freely configurable.

Electronics

| | |
|-------------------------------------|---------------------------------|
| Protection class | III (EN 61140) |
| Supply voltage V_s | 24 V DC (16.8 V DC ... 30 V DC) |
| Power consumption typical | 8.1 W (without output load) |

Mechanics

| | |
|------------------------------------|--|
| Dimensions (W x H x D) | 112 mm x 163 mm x 111.1 mm |
| Weight | 1.6 kg |
| Housing material | Aluminum |
| Housing color | RAL 1021 (yellow), RAL 9005 (black) |
| Optics cover material | Polycarbonate |
| Optics cover surface finish | Outside with scratch-resistant coating |

Ambient data

| | |
|--------------------------------------|--|
| Enclosure rating | IP65 (IEC 60529) |
| Ambient light immunity | ≤ 40 klx (IEC 61496-3) ¹⁾ |
| Ambient operating temperature | -10 °C ... +50 °C |
| Storage temperature | -25 °C ... +70 °C |
| Vibration resistance | IEC 60068-2-6, IEC 60068-2-64, IEC 60721-3-5, IEC TR 60721-4-3, IEC 61496-1, IEC 61496-3 |
| Class | 5M1 (IEC 60721-3-5) 3M4 (IEC TR 60721-4-3) |
| Shock resistance | IEC 60068-2-27, IEC 60721-3-5, IEC TR 60721-4-3, IEC 61496-1, IEC 61496-3 |
| Class | 5M1 (IEC 60721-3-5) 3M4 (IEC TR 60721-4-3) |
| Continuous shock | 100 m/s ² , 16 ms 150 m/s ² , 6 ms |
| EMC | IEC 61496-1, IEC 61000-6-2, IEC 61000-6-4 |

¹⁾ Typical ambient light immunity, for ambient light sources directly in the scan plane in accordance with IEC 61496-3: ≤ 3 klx.

Other information

| | |
|------------------------------------|---|
| Type of light | Pulsed laser diode |
| Wave length | 845 nm |
| Detectable remission factor | 1.8% to several 1000% |
| Laser class | 1 (21 CFR 1040.10 and 1040.11, IEC 60825-1) |

Certificates

| | |
|-------------------------------------|---|
| UK declaration of conformity | ✓ |
|-------------------------------------|---|

| | |
|--|---|
| ACMA declaration of conformity | ✓ |
| China RoHS | ✓ |
| cULus certificate | ✓ |
| Ethernet/IP certificate | ✓ |
| EC-Type-Examination approval | ✓ |
| China GB certificate | ✓ |
| Information according to Art. 3 of Data Act (Regulation EU 2023/2854) | ✓ |

Classifications

| | |
|-----------------------|----------|
| ECLASS 5.0 | 27272705 |
| ECLASS 5.1.4 | 27272705 |
| ECLASS 6.0 | 27272705 |
| ECLASS 6.2 | 27272705 |
| ECLASS 7.0 | 27272705 |
| ECLASS 8.0 | 27272705 |
| ECLASS 8.1 | 27272705 |
| ECLASS 9.0 | 27272705 |
| ECLASS 10.0 | 27272705 |
| ECLASS 11.0 | 27272705 |
| ECLASS 12.0 | 27272705 |
| ETIM 5.0 | EC002550 |
| ETIM 6.0 | EC002550 |
| ETIM 7.0 | EC002550 |
| ETIM 8.0 | EC002550 |
| UNSPSC 16.0901 | 39121528 |

Dimensional drawing

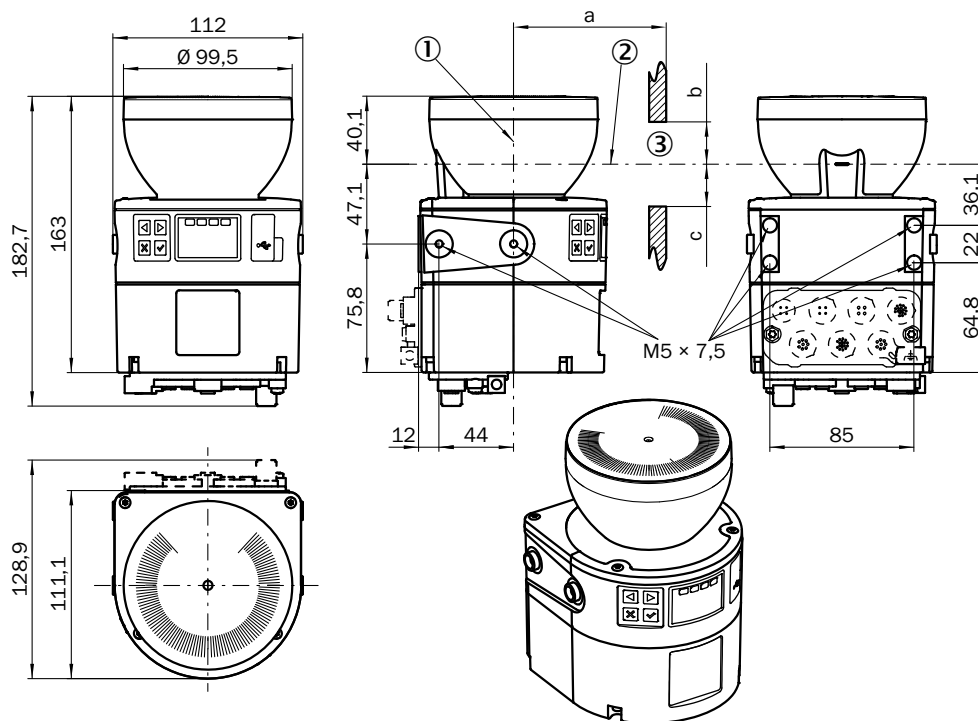

Dimensions in mm (inch)

① mirror axis of rotation

② scan plane

③ required viewing slit (a: length of the viewing slit, b: minimum height above the scan plane, c: minimum height below the scan plane. See the operating instructions for details.)

Pinouts Dynamic control input (XG2, XG3)

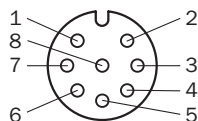

| Pin | Designation | Description |
|-----|-------------|---|
| 1 | n.c. | Not connected |
| 2 | Inc 0° | Incremental encoder signal (0°) |
| 3 | n.c. | Not connected |
| 4 | Inc 90° | Incremental encoder signal (90°) |
| 5 | n.c. | Not connected |
| 6 | n.c. | Not connected |
| 7 | 0 V Inc | Supply voltage for incremental encoder (0 V DC) |
| 8 | 24 V DC Inc | Supply voltage for incremental encoder (+24 V DC) |

For details see operating instructions

Pinouts Local inputs and outputs (XG4)

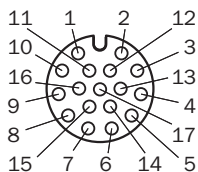

| Pin | Designation | Description |
|-----|-------------|---|
| 1 | OSSD 3.A | OSSD pair 3, OSSD A |
| 2 | OSSD 3.B | OSSD pair 3, OSSD B |
| 3 | OSSD 4.A | OSSD pair 4, OSSD A |
| 4 | OSSD 4.B | OSSD pair 4, OSSD B |
| 5 | n.c. | Not connected |
| 6 | n.c. | Not connected |
| 7 | n.c. | Not connected |
| 8 | n.c. | Not connected |
| 9 | Uni-I 11 | Universal input 11, configurable |
| 10 | Uni-I 12 | Universal input 12, configurable |
| 11 | Uni-I 13 | Universal input 13, configurable |
| 12 | Uni-I 14 | Universal input 14, configurable |
| 13 | Uni-I 15 | Universal input 15, configurable |
| 14 | Uni-I 16 | Universal input 16, configurable |
| 15 | Uni-O 03 | Universal output 3 |
| 16 | Uni-O 04 | Universal output 4 |
| 17 | 0 V DC | Voltage for inputs and outputs (0 V DC) * |

* If at least one connection of the female connector is used, this 0 V connection must be connected in the control cabinet to 0 V DC of the power supply unit using a low-impedance and star-point connection.

For details see operating instructions

Pinouts Local inputs and outputs (XG1)

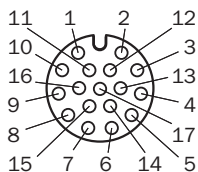

| Pin | Designation | Description |
|-----|-------------|---------------------------------|
| 1 | OSSD 1.A | OSSD pair 1, OSSD A |
| 2 | OSSD 1.B | OSSD pair 1, OSSD B |
| 3 | OSSD 2.A | OSSD pair 2, OSSD A |
| 4 | OSSD 2.B | OSSD pair 2, OSSD B |
| 5 | Uni-I 01 | Universal input 1, configurable |
| 6 | Uni-I 02 | Universal input 2, configurable |
| 7 | Uni-I 03 | Universal input 3, configurable |

| Pin | Designation | Description |
|-----|-------------|---|
| 8 | Uni-I 04 | Universal input 4, configurable |
| 9 | Uni-I 05 | Universal input 5, configurable |
| 10 | Uni-I 06 | Universal input 6, configurable |
| 11 | Uni-I 07 | Universal input 7, configurable |
| 12 | Uni-I 08 | Universal input 8, configurable |
| 13 | Uni-I 09 | Universal input 9, configurable |
| 14 | Uni-I 10 | Universal input 10, configurable |
| 15 | Uni-O 01 | Universal output 1 |
| 16 | Uni-O 02 | Universal output 2 |
| 17 | 0 V DC | Voltage for inputs and outputs (0 V DC) * |

* If at least one connection of the female connector is used, this 0 V connection must be connected in the control cabinet to 0 V DC of the power supply unit using a low-impedance and star-point connection.

For details see operating instructions

Pinouts Voltage supply (XD1)

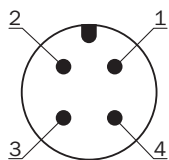

| Pin | Designation | Description |
|-----|-------------|----------------------------|
| 1 | +24 V DC | Supply voltage +24 V DC |
| 2 | n.c. | Not connected |
| 3 | 0 V DC | Supply voltage 0 V DC |
| 4 | FE | Functional earth/shielding |

For details see operating instructions

Pinouts Ethernet (XF1, XF2)

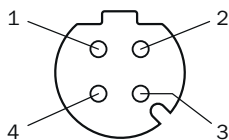







| Pin | Designation | Description |
|--------|-------------|----------------|
| 1 | TX+ | Send data + |
| 2 | RX+ | Receive data + |
| 3 | TX- | Send data - |
| 4 | RX- | Receive data - |
| Thread | SH | Shielding |

For details see operating instructions

Recommended accessories

Other models and accessories → www.sick.com/microScan3

| | Brief description | Type | part no. |
|---|---|--|----------|
| Mounting systems | | | |
|  | <ul style="list-style-type: none"> Description: Mounting bracket, heavy-duty version, with protection cover, for floor mounting, height adjustment possible from 90 ... 310 mm, scanner tilt angle: $\pm 5^\circ$. Additional mounting brackets are not required. Dimensions (W x H x L): 200 mm x 366 mm x 269 mm Material: Steel Details: Steel, painted (RAL 1021) Color: RAL 1021 (yellow) Packing unit: 1 piece | Heavy-duty mounting kit for floor mounting | 2102289 |
|  | <ul style="list-style-type: none"> Description: Mounting bracket with protection of optics hood Material: Stainless steel Details: Stainless steel V2A (1.4301), powder-coated IGP-DURA face 5803A Color: RAL 9005 (black) Packing unit: 1 piece | 1b mounting kit | 2074242 |
|  | <ul style="list-style-type: none"> Description: Mounting bracket Material: Stainless steel Details: Stainless steel V2A (1.4301), powder-coated IGP-DURA face 5803A Color: RAL 9005 (black) Packing unit: 1 piece | Mounting kit 1a | 2073851 |
|  | <ul style="list-style-type: none"> Description: Alignment bracket, alignment with cross-wise axis and depth axis possible, distance between mounting surface and device: 22.3 mm, only in conjunction with mounting kit 1a (2073851) or 1b (2074242) Material: Stainless steel Details: Stainless steel V2A (1.4301), powder-coated IGP-DURA face 5803A Color: RAL 9005 (black) Packing unit: 1 piece | Mounting kit 2a | 2073852 |
|  | <ul style="list-style-type: none"> Description: Mounting bracket 150 mm for floor mounting of microScan3 Material: Stainless steel Details: Stainless steel Color: Uncoated Packing unit: 1 piece Items supplied: Bracket and 4 x M5 screws for attaching the microScan3 | Mounting bracket 150 mm for floor mounting of microScan3 | 2112950 |
|  | <ul style="list-style-type: none"> Description: Mounting bracket 300 mm for floor mounting of microScan3 Material: Stainless steel Details: Stainless steel Color: Uncoated Packing unit: 1 piece Items supplied: Bracket and 4 x M5 screws for attaching the microScan3 | Mounting bracket 300 mm for floor mounting of microScan3 | 2112951 |
|  | <ul style="list-style-type: none"> Description: Alignment bracket, alignment with cross-wise axis and depth axis possible, distance between mounting surface and device: 52.3 mm, only in conjunction with mounting kit 1a (2073851) or 1b (2074242) Material: Stainless steel Details: Stainless steel V2A (1.4301), powder-coated IGP-DURA face 5803A Color: RAL 9005 (black) Packing unit: 1 piece | Mounting kit 2b | 2074184 |

| | Brief description | Type | part no. |
|---|---|---------------------|----------|
| connectors and cables | | | |
|  | <ul style="list-style-type: none"> Description: Sensor/actuator cable, unshielded Connection type head A: Female connector, M12, 4-pin, straight Connection type head B: Flying leads Signal type: Sensor/actuator cable Cable: 5 m, 4-wire, PUR, halogen-free Connection systems: Flying leads Application: Drag chain operation, Zones with oils and lubricants | DOL-1204G05M-C75KM0 | 2079291 |
|  | <ul style="list-style-type: none"> Description: Sensor/actuator cable, unshielded Connection type head A: Female connector, M12, 4-pin, angled Connection type head B: Flying leads Signal type: Sensor/actuator cable Cable: 5 m, 4-wire, PUR, halogen-free Connection systems: Flying leads Application: Drag chain operation, Zones with oils and lubricants | DOL-1204W05M-C75KM0 | 2079294 |
|  | <ul style="list-style-type: none"> Description: Sensor/actuator cable, shielded Connection type head A: Female connector, M12, 8-pin, straight, A-coded Connection type head B: Male connector, M12, 8-pin, straight, A-coded Signal type: Sensor/actuator cable Cable: 2 m, 8-wire, PUR, halogen-free Application: Drag chain operation, Zones with oils and lubricants, Robot, Drag chain operation | YF2A28-020UA6M2A28 | 2096105 |
|  | <ul style="list-style-type: none"> Connection type head A: Male connector, M12, 4-pin, angled, D-coded Connection type head B: Male connector, RJ45, 8-pin, straight Signal type: Ethernet Cable: 20 m, 4-wire, CAT5, CAT5e, PUR, halogen-free Description: Ethernet, shielded | SSL-2J04-H20ME | 6063701 |
|  | <ul style="list-style-type: none"> Connection type head A: Male connector, M12, 4-pin, straight, D-coded Connection type head B: Male connector, RJ45, 4-pin, straight Signal type: Ethernet, PROFINET Cable: 5 m, 4-wire, PUR, halogen-free Description: Ethernet, shielded, PROFINET Application: Drag chain operation, Zones with oils and lubricants | YM2D24-050P-N1MRJA4 | 2106184 |
|  | <ul style="list-style-type: none"> Connection type head A: Male connector, M12, 4-pin, angled, D-coded Connection type head B: Male connector, RJ45, 4-pin, straight Signal type: Ethernet, PROFINET Cable: 5 m, 4-wire, PUR, halogen-free Description: Ethernet, shielded, PROFINET Application: Drag chain operation, Zones with oils and lubricants | YN2D24-050P-N1MRJA4 | 2106163 |
|  | <ul style="list-style-type: none"> Description: Sensor/actuator cable, unshielded Connection type head A: Male connector, M12, 17-pin, straight Connection type head B: Flying leads Signal type: Sensor/actuator cable Cable: 10 m, 17-wire, PUR Application: Zones with oils and lubricants, Zones with oils and lubricants, Robot, Drag chain operation | YM2A1D-100U-V1XLEAX | 2118016 |
|  | <ul style="list-style-type: none"> Description: Sensor/actuator cable, unshielded Connection type head A: Male connector, M12, 17-pin, angled Connection type head B: Flying leads Signal type: Sensor/actuator cable Cable: 10 m, 17-wire, PUR Application: Zones with oils and lubricants, Zones with oils and lubricants, Robot, Drag chain operation | YN2A1D-100U-V1XLEAX | 2118011 |

SICK AT A GLANCE

SICK is one of the leading manufacturers of intelligent sensors and sensor solutions for industrial applications. A unique range of products and services creates the perfect basis for controlling processes securely and efficiently, protecting individuals from accidents and preventing damage to the environment.

We have extensive experience in a wide range of industries and understand their processes and requirements. With intelligent sensors, we can deliver exactly what our customers need. In application centers in Europe, Asia and North America, system solutions are tested and optimized in accordance with customer specifications. All this makes us a reliable supplier and development partner.

Comprehensive services complete our offering: SICK LifeTime Services provide support throughout the machine life cycle and ensure safety and productivity.

For us, that is “Sensor Intelligence.”

WORLDWIDE PRESENCE:

Contacts and other locations –www.sick.com