



MICS3-CCAZ40AA1P01

microScan3

SAFETY LASER SCANNERS

SICK
Sensor Intelligence.



Illustration may differ

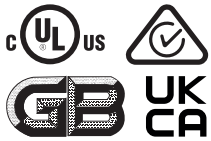

Ordering information

Type	part no.
MICS3-CCAZ40AA1P01	1110035

Other models and accessories → www.sick.com/microScan3

Detailed technical data

Features

Product version	microScan3 Pro I/O - EFI-pro
Model	Sensor including system plug (pre-mounted on the underside)
Application	Indoor
Protective field range	4 m
Warning field range	40 m
Number of simultaneously monitored fields	≤ 8 ¹⁾
Number of fields	128
Number of monitoring cases	128
Scanning angle	275°
Resolution (can be configured)	30 mm 40 mm 50 mm 70 mm 150 mm 200 mm
Angular resolution	0.39°
Response time	70 ms
Protective field supplement	65 mm

¹⁾ Protection, warning or contour detection fields.

Safety-related parameters

Type	Type 3 (IEC 61496)
Safety integrity level	SIL 2 (IEC 61508)
Category	Category 3 (EN ISO 13849)
Performance level	PL d (EN ISO 13849)

PFH_D (mean probability of a dangerous failure per hour)	8.0 x 10 ⁻⁸
T_M (mission time)	20 years (EN ISO 13849)
Safe state in the event of a fault	At least one OSSD is in the OFF state. The safety outputs via the network are logic 0.

Functions

Restart interlock	✓
External device monitoring (EDM)	✓
Multiple sampling	✓
Monitoring case switching	✓
Simultaneous monitoring	✓
Static protective field switching	✓
Safe contour detection	✓
Contour as a reference	✓
Integrated configuration memory	✓
Measured data output	Via Ethernet
Safe SICK device communication via EFI-pro	✓

Interfaces

Connection type	
Voltage supply	1 x male connector, M12, 4-pin, A-coded
Local inputs and outputs (I/O)	2 x female connector, M12, 17-pin, A-coded
Dynamic switching signals	2 x female connector, M12, 8-pin, A-coded
Fieldbus, industrial network	2 x M12 female connectors, 4-pin, D-coded
Outputs	
OSSD pairs	4
Safety outputs via network	8
Universal outputs	4 ¹⁾
Inputs	
Universal inputs	16 ¹⁾
Dynamic switching signals	2
Static control inputs	8
Configuration method	PC with Safety Designer (Configuration and Diagnostic Software)
Configuration and diagnostics interface	USB 2.0, Mini-USB, Ethernet
Data interface	
Services	EtherNet/IP™ CIP Safety™ CoLa 2 (configuration and diagnostics using Safety Designer)
	Data output
	DHCP
	SNMP
	SNTP (client and server)

¹⁾ Freely configurable.

Fieldbus, industrial network	EFI-pro
RPI (requested packet interval)	5 ms ... 1,000 ms, multiple of 5 ms
Display elements	Graphic color display, LEDs

¹⁾ Freely configurable.

Electronics

Protection class	III (EN 61140)
Supply voltage V_s	24 V DC (16.8 V DC ... 30 V DC)
Power consumption typical	8.1 W (without output load)

Mechanics

Dimensions (W x H x D)	112 mm x 163 mm x 111.1 mm
Weight	1.6 kg
Housing material	Aluminum
Housing color	RAL 1021 (yellow), RAL 9005 (black)
Optics cover material	Polycarbonate
Optics cover surface finish	Outside with scratch-resistant coating

Ambient data

Enclosure rating	IP65 (IEC 60529)
Ambient light immunity	≤ 40 klx (IEC 61496-3) ¹⁾
Ambient operating temperature	-10 °C ... +50 °C
Storage temperature	-25 °C ... +70 °C
Vibration resistance	IEC 60068-2-6, IEC 60068-2-64, IEC 60721-3-5, IEC TR 60721-4-3, IEC 61496-1, IEC 61496-3
Class	5M1 (IEC 60721-3-5) 3M4 (IEC TR 60721-4-3)
Shock resistance	IEC 60068-2-27, IEC 60721-3-5, IEC TR 60721-4-3, IEC 61496-1, IEC 61496-3
Class	5M1 (IEC 60721-3-5) 3M4 (IEC TR 60721-4-3)
Continuous shock	100 m/s ² , 16 ms 150 m/s ² , 6 ms
EMC	IEC 61496-1, IEC 61000-6-2, IEC 61000-6-4

¹⁾ Typical ambient light immunity, for ambient light sources directly in the scan plane in accordance with IEC 61496-3: ≤ 3 klx.

Other information

Type of light	Pulsed laser diode
Wave length	845 nm
Detectable remission factor	1.8% to several 1000%
Laser class	1 (21 CFR 1040.10 and 1040.11, IEC 60825-1)

Certificates

UK declaration of conformity	✓
ACMA declaration of conformity	✓
China RoHS	✓

cULus certificate	✓
Ethernet/IP certificate	✓
EC-Type-Examination approval	✓
China GB certificate	✓
Information according to Art. 3 of Data Act (Regulation EU 2023/2854)	✓

Classifications

ECLASS 5.0	27272705
ECLASS 5.1.4	27272705
ECLASS 6.0	27272705
ECLASS 6.2	27272705
ECLASS 7.0	27272705
ECLASS 8.0	27272705
ECLASS 8.1	27272705
ECLASS 9.0	27272705
ECLASS 10.0	27272705
ECLASS 11.0	27272705
ECLASS 12.0	27272705
ETIM 5.0	EC002550
ETIM 6.0	EC002550
ETIM 7.0	EC002550
ETIM 8.0	EC002550
UNSPSC 16.0901	39121528

Dimensional drawing

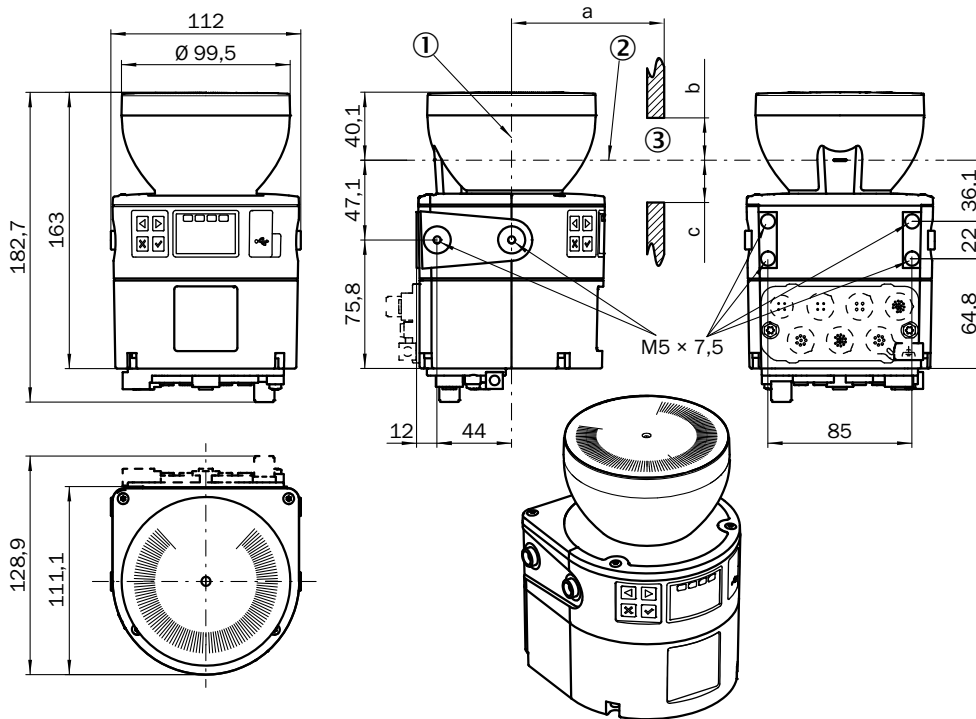

Dimensions in mm (inch)

① mirror axis of rotation

② scan plane

③ required viewing slit (a: length of the viewing slit, b: minimum height above the scan plane, c: minimum height below the scan plane. See the operating instructions for details.)

Pinouts Dynamic control input (XG2, XG3)

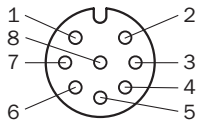

Pin	Designation	Description
1	n.c.	Not connected
2	Inc 0°	Incremental encoder signal (0°)
3	n.c.	Not connected
4	Inc 90°	Incremental encoder signal (90°)
5	n.c.	Not connected
6	n.c.	Not connected
7	0 V Inc	Supply voltage for incremental encoder (0 V DC)
8	24 V DC Inc	Supply voltage for incremental encoder (+24 V DC)

For details see operating instructions

Pinouts Local inputs and outputs (XG4)

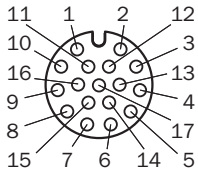

Pin	Designation	Description
1	OSSD 3.A	OSSD pair 3, OSSD A
2	OSSD 3.B	OSSD pair 3, OSSD B
3	OSSD 4.A	OSSD pair 4, OSSD A
4	OSSD 4.B	OSSD pair 4, OSSD B
5	n.c.	Not connected
6	n.c.	Not connected
7	n.c.	Not connected
8	n.c.	Not connected
9	Uni-I 11	Universal input 11, configurable
10	Uni-I 12	Universal input 12, configurable
11	Uni-I 13	Universal input 13, configurable
12	Uni-I 14	Universal input 14, configurable
13	Uni-I 15	Universal input 15, configurable
14	Uni-I 16	Universal input 16, configurable
15	Uni-O 03	Universal output 3
16	Uni-O 04	Universal output 4
17	0 V DC	Voltage for inputs and outputs (0 V DC) *

* If at least one connection of the female connector is used, this 0 V connection must be connected in the control cabinet to 0 V DC of the power supply unit using a low-impedance and star-point connection.

For details see operating instructions

Pinouts Local inputs and outputs (XG1)

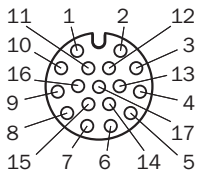

Pin	Designation	Description
1	OSSD 1.A	OSSD pair 1, OSSD A
2	OSSD 1.B	OSSD pair 1, OSSD B
3	OSSD 2.A	OSSD pair 2, OSSD A
4	OSSD 2.B	OSSD pair 2, OSSD B
5	Uni-I 01	Universal input 1, configurable
6	Uni-I 02	Universal input 2, configurable
7	Uni-I 03	Universal input 3, configurable

Pin	Designation	Description
8	Uni-I 04	Universal input 4, configurable
9	Uni-I 05	Universal input 5, configurable
10	Uni-I 06	Universal input 6, configurable
11	Uni-I 07	Universal input 7, configurable
12	Uni-I 08	Universal input 8, configurable
13	Uni-I 09	Universal input 9, configurable
14	Uni-I 10	Universal input 10, configurable
15	Uni-O 01	Universal output 1
16	Uni-O 02	Universal output 2
17	0 V DC	Voltage for inputs and outputs (0 V DC) *

* If at least one connection of the female connector is used, this 0 V connection must be connected in the control cabinet to 0 V DC of the power supply unit using a low-impedance and star-point connection.

For details see operating instructions

Pinouts Voltage supply (XD1)

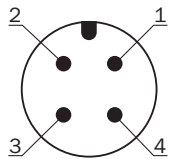

Pin	Designation	Description
1	+24 V DC	Supply voltage +24 V DC
2	n.c.	Not connected
3	0 V DC	Supply voltage 0 V DC
4	FE	Functional earth/shielding

For details see operating instructions

Pinouts Ethernet (XF1, XF2)

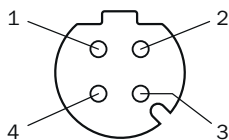







Pin	Designation	Description
1	TX+	Send data +
2	RX+	Receive data +
3	TX-	Send data -
4	RX-	Receive data -
Thread	SH	Shielding

For details see operating instructions

Recommended accessories

Other models and accessories → www.sick.com/microScan3

	Brief description	Type	part no.
Mounting systems			
	<ul style="list-style-type: none"> Description: Mounting bracket, heavy-duty version, with protection cover, for floor mounting, height adjustment possible from 90 ... 310 mm, scanner tilt angle: $\pm 5^\circ$. Additional mounting brackets are not required. Dimensions (W x H x L): 200 mm x 366 mm x 269 mm Material: Steel Details: Steel, painted (RAL 1021) Color: RAL 1021 (yellow) Packing unit: 1 piece 	Heavy-duty mounting kit for floor mounting	2102289
	<ul style="list-style-type: none"> Description: Mounting bracket with protection of optics hood Material: Stainless steel Details: Stainless steel V2A (1.4301), powder-coated IGP-DURA face 5803A Color: RAL 9005 (black) Packing unit: 1 piece 	1b mounting kit	2074242
	<ul style="list-style-type: none"> Description: Mounting bracket Material: Stainless steel Details: Stainless steel V2A (1.4301), powder-coated IGP-DURA face 5803A Color: RAL 9005 (black) Packing unit: 1 piece 	Mounting kit 1a	2073851
	<ul style="list-style-type: none"> Description: Alignment bracket, alignment with cross-wise axis and depth axis possible, distance between mounting surface and device: 22.3 mm, only in conjunction with mounting kit 1a (2073851) or 1b (2074242) Material: Stainless steel Details: Stainless steel V2A (1.4301), powder-coated IGP-DURA face 5803A Color: RAL 9005 (black) Packing unit: 1 piece 	Mounting kit 2a	2073852
	<ul style="list-style-type: none"> Description: Mounting bracket 150 mm for floor mounting of microScan3 Material: Stainless steel Details: Stainless steel Color: Uncoated Packing unit: 1 piece Items supplied: Bracket and 4 x M5 screws for attaching the microScan3 	Mounting bracket 150 mm for floor mounting of microScan3	2112950
	<ul style="list-style-type: none"> Description: Mounting bracket 300 mm for floor mounting of microScan3 Material: Stainless steel Details: Stainless steel Color: Uncoated Packing unit: 1 piece Items supplied: Bracket and 4 x M5 screws for attaching the microScan3 	Mounting bracket 300 mm for floor mounting of microScan3	2112951
	<ul style="list-style-type: none"> Description: Alignment bracket, alignment with cross-wise axis and depth axis possible, distance between mounting surface and device: 52.3 mm, only in conjunction with mounting kit 1a (2073851) or 1b (2074242) Material: Stainless steel Details: Stainless steel V2A (1.4301), powder-coated IGP-DURA face 5803A Color: RAL 9005 (black) Packing unit: 1 piece 	Mounting kit 2b	2074184

	Brief description	Type	part no.
connectors and cables			
	<ul style="list-style-type: none"> Description: Sensor/actuator cable, unshielded Connection type head A: Female connector, M12, 4-pin, straight Connection type head B: Flying leads Signal type: Sensor/actuator cable Cable: 5 m, 4-wire, PUR, halogen-free Connection systems: Flying leads Application: Drag chain operation, Zones with oils and lubricants 	DOL-1204G05M-C75KM0	2079291
	<ul style="list-style-type: none"> Description: Sensor/actuator cable, unshielded Connection type head A: Female connector, M12, 4-pin, angled Connection type head B: Flying leads Signal type: Sensor/actuator cable Cable: 5 m, 4-wire, PUR, halogen-free Connection systems: Flying leads Application: Drag chain operation, Zones with oils and lubricants 	DOL-1204W05M-C75KM0	2079294
	<ul style="list-style-type: none"> Description: Sensor/actuator cable, shielded Connection type head A: Female connector, M12, 8-pin, straight, A-coded Connection type head B: Male connector, M12, 8-pin, straight, A-coded Signal type: Sensor/actuator cable Cable: 2 m, 8-wire, PUR, halogen-free Application: Drag chain operation, Zones with oils and lubricants, Robot, Drag chain operation 	YF2A28-020UA6M2A28	2096105
	<ul style="list-style-type: none"> Connection type head A: Male connector, M12, 4-pin, angled, D-coded Connection type head B: Male connector, RJ45, 8-pin, straight Signal type: Ethernet Cable: 20 m, 4-wire, CAT5, CAT5e, PUR, halogen-free Description: Ethernet, shielded 	SSL-2J04-H20ME	6063701
	<ul style="list-style-type: none"> Connection type head A: Male connector, M12, 4-pin, straight, D-coded Connection type head B: Male connector, RJ45, 4-pin, straight Signal type: Ethernet, PROFINET Cable: 5 m, 4-wire, PUR, halogen-free Description: Ethernet, shielded, PROFINET Application: Drag chain operation, Zones with oils and lubricants 	YM2D24-050P-N1MRJA4	2106184
	<ul style="list-style-type: none"> Connection type head A: Male connector, M12, 4-pin, angled, D-coded Connection type head B: Male connector, RJ45, 4-pin, straight Signal type: Ethernet, PROFINET Cable: 5 m, 4-wire, PUR, halogen-free Description: Ethernet, shielded, PROFINET Application: Drag chain operation, Zones with oils and lubricants 	YN2D24-050P-N1MRJA4	2106163
	<ul style="list-style-type: none"> Description: Sensor/actuator cable, unshielded Connection type head A: Male connector, M12, 17-pin, straight Connection type head B: Flying leads Signal type: Sensor/actuator cable Cable: 10 m, 17-wire, PUR Application: Zones with oils and lubricants, Zones with oils and lubricants, Robot, Drag chain operation 	YM2A1D-100U-V1XLEAX	2118016
	<ul style="list-style-type: none"> Description: Sensor/actuator cable, unshielded Connection type head A: Male connector, M12, 17-pin, angled Connection type head B: Flying leads Signal type: Sensor/actuator cable Cable: 10 m, 17-wire, PUR Application: Zones with oils and lubricants, Zones with oils and lubricants, Robot, Drag chain operation 	YN2A1D-100U-V1XLEAX	2118011

SICK AT A GLANCE

SICK is one of the leading manufacturers of intelligent sensors and sensor solutions for industrial applications. A unique range of products and services creates the perfect basis for controlling processes securely and efficiently, protecting individuals from accidents and preventing damage to the environment.

We have extensive experience in a wide range of industries and understand their processes and requirements. With intelligent sensors, we can deliver exactly what our customers need. In application centers in Europe, Asia and North America, system solutions are tested and optimized in accordance with customer specifications. All this makes us a reliable supplier and development partner.

Comprehensive services complete our offering: SICK LifeTime Services provide support throughout the machine life cycle and ensure safety and productivity.

For us, that is “Sensor Intelligence.”

WORLDWIDE PRESENCE:

Contacts and other locations –www.sick.com