



GSE6L-E6211

G6

PHOTOELECTRIC SENSORS

SICK
Sensor Intelligence.



Illustration may differ

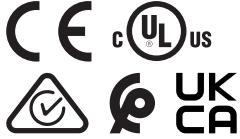

Ordering information

Type	part no.
GSE6L-E6211	1109741

Other models and accessories → www.sick.com/G6

Detailed technical data

Features

Functional principle	Through-beam photoelectric sensor
Sensing range	
Sensing range min.	0 m
Sensing range max.	40 m
Recommended sensing range for the best performance	0 m ... 30 m
Polarisation filter	No
Emitted beam	
Light source	Laser
Type of light	Visible red light
Shape of light spot	Point-shaped
Light spot size (distance)	Ø 3.5 mm (1,000 mm)
Maximum dispersion of the emitted beam around the standardized transmission axis (squint angle)	< +/- 1.5° (at T _U = +23 °C)
Key laser figures	
Normative reference	IEC 60825-1 / CDRH 21 CFR 1040.10 & 1040.11
Laser class	1 ¹⁾
Wave length	680 nm
Pulse duration	3 µs
Maximum pulse power	≤ 7.8 mW
Average service life	100,000 h at T _a = +25 °C
Smallest detectable object (MDO) typ.	
	3.5 mm, at 1 m distance (object with 90% remission factor (corresponds to standard white according to DIN 5033))
Adjustment	
Potentiometer	For setting the sensing range
Operating mode switch	For inverting the switching function (light/dark switching)

¹⁾ Do not intentionally look into the laser beam. Never point the laser beam at people's eyes.

Display	LED green	Operating indicator Static on: power on
	LED yellow	Status of received light beam Static on: object present Static off: object not present

¹⁾ Do not intentionally look into the laser beam. Never point the laser beam at people's eyes.

Safety-related parameters

MTTF_D	1,005 years
DC_{avg}	0 %
T_M (mission time)	10 years

Electronics

Supply voltage U_B	10 V DC ... 30 V DC ¹⁾
Ripple	< 5 V _{pp}
Usage category	DC-13 (According to EN 60947-5-2)
Current consumption	≤ 20 mA, without load. At U _B = 24 V
Protection class	III
Digital output	
Number	2 (Complementary)
Type	NPN
Switching mode	Light/dark switching
Signal voltage PNP HIGH/LOW	Approx. U _B -3 V / 0 V
Output current I _{max.}	≤ 100 mA ²⁾
Circuit protection outputs	Reverse polarity protected Overcurrent protected Short-circuit protected
Response time	≤ 625 μs
Switching frequency	1,000 Hz ³⁾
Pin/Wire assignment	
Function of pin 4/black (BK)	Digital output, light switching, object present → output Q HIGH
Function of pin 4/black (BK) – detail	The pin 4 function of the sensor can be switched Additional possible settings via operating mode switch
Function of pin 2/white (WH)	Digital output, dark switching, object present → output \bar{Q} LOW
Function of pin 2/white (WH) – detail	The pin 2 function of the sensor can be switched Additional possible settings via operating mode switch

¹⁾ Limit values.

²⁾ At U_B > 24 V, I max. = 50 mA.

³⁾ With light/dark ratio 1:1.

Mechanics

Housing	Rectangular
Dimensions (W x H x D)	12 mm x 31.5 mm x 21 mm
Connection	Cable with M8 male connector, 4-pin, 336 mm

Connection detail	
Deep-freeze property	Do not bend below 0 °C
Conductor size	0.14 mm ²
Cable diameter	Ø 8 mm
Length of cable (L)	300 mm
Material	
Housing	Plastic, ABS
Front screen	Plastic, PMMA
Cable	Plastic, PVC
Male connector	Metal, copper alloy (C3604 CUZN39PB3)
Weight	Approx. 60 g

Ambient data

Enclosure rating	IP67 (EN 60529)
Ambient operating temperature	-20 °C ... +50 °C ^{1) 2)}
Ambient temperature, storage	-40 °C ... +70 °C
Typ. Ambient light immunity	Sunlight: ≤ 13,000 lx
Shock resistance	30 g, 11 ms (3 positive and 3 negative shocks along X, Y, Z axes, 18 total shocks (EN60068-2-27))
Vibration resistance	10 Hz ... 55 Hz (Amplitude 0.5 mm, 3 x 30 min (EN60068-2-6))
Air humidity	35 % ... 95 %, relative humidity (no condensation)
Electromagnetic compatibility (EMC)	EN 60947-5-2
UL File No.	NRKH.E348498 & NRKH7.E348498

¹⁾ As of T_a => 45 °C, a max. supply voltage U_B = 24 V and a max. load current I_{max.} = 50 mA is permitted.

²⁾ Below T_u = -20 °C, a warm-up time of 3 seconds is required.

Certificates

EU declaration of conformity	✓
UK declaration of conformity	✓
ACMA declaration of conformity	✓
Moroccan declaration of conformity	✓
China RoHS	✓
cULus certificate	✓
Laser safety (IEC 60825-1) declaration of manufacturer	✓

Classifications

ECLASS 5.0	27270901
ECLASS 5.1.4	27270901
ECLASS 6.0	27270901
ECLASS 6.2	27270901
ECLASS 7.0	27270901
ECLASS 8.0	27270901
ECLASS 8.1	27270901

ECLASS 9.0	27270901
ECLASS 10.0	27270901
ECLASS 11.0	27270901
ECLASS 12.0	27270901
ETIM 5.0	EC002716
ETIM 6.0	EC002716
ETIM 7.0	EC002716
ETIM 8.0	EC002716
UNSPSC 16.0901	39121528

Dimensional drawing

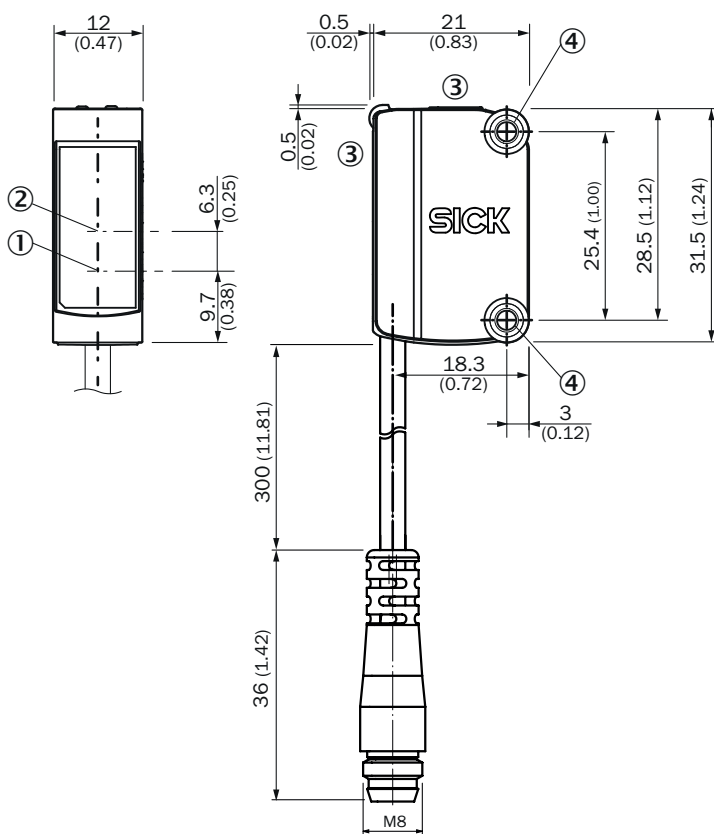

Dimensions in mm (inch)

- ① Center of optical axis, sender
- ② Center of optical axis, receiver
- ③ display and adjustment elements
- ④ Mounting holes M3

display and adjustment elements

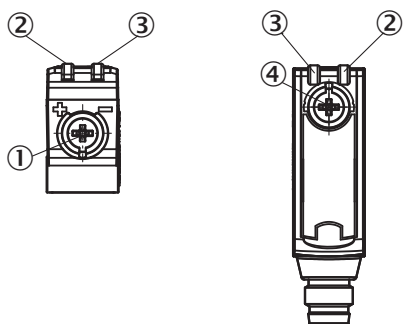

- ① Potentiometer
- ② LED yellow
- ③ LED green
- ④ operating mode switch

pinouts

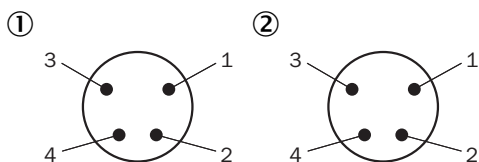

male connector M8, 4-pin

- ① receiver
- ② sender

Connection diagram Cd-232

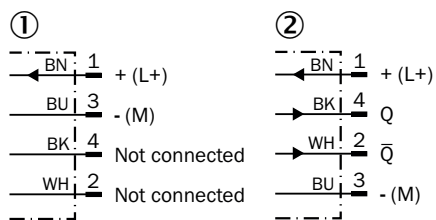

- ① sender
- ② receiver

Truth table NPN - light switching

	Light switching Q (normally closed)	
	Object not present → Output LOW	Object present → Output HIGH
Light receive	✓	✗
Light receive indicator	☀	✗
Load resistance	⚡	✗

Truth table NPN - dark switching

	Dark switching \bar{Q} (normally open)	
	Object not present → Output HIGH	Object present → Output LOW
Light receive	✓	✗
Light receive indicator	☀	✗
Load resistance	✗	⚡

Characteristic curve

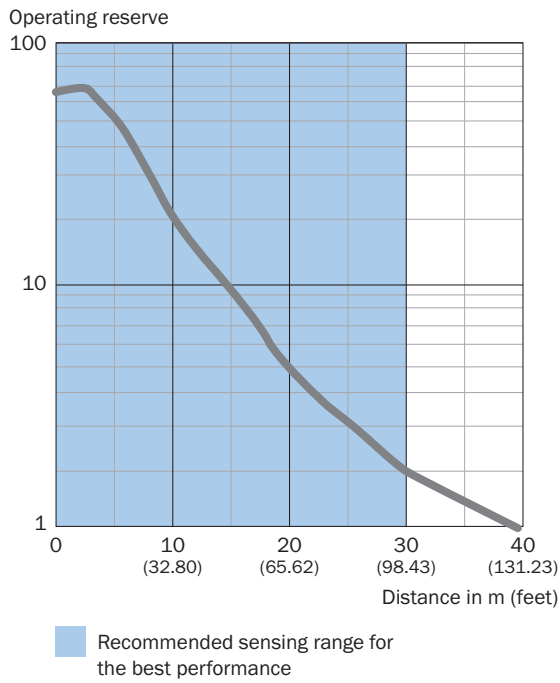

Light spot size

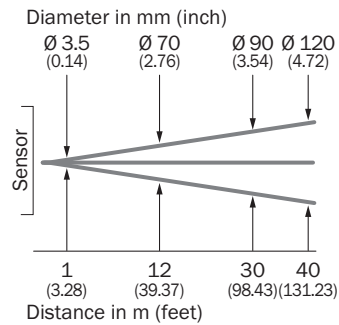

Sensing range diagram

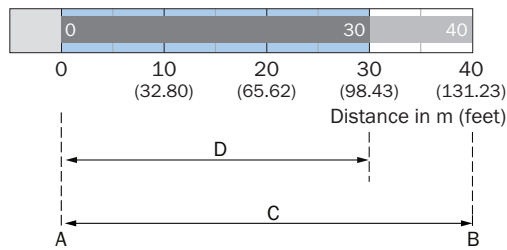







- A = Sensing range min. in m
- B = Sensing range max. in m
- C = Viewing range
- D = Adjustable switching threshold

 Recommended sensing range for the best performance

Recommended accessories

Other models and accessories → www.sick.com/G6

	Brief description	Type	part no.
Mounting systems			
	<ul style="list-style-type: none"> • Description: Clamp bar to fix G6 sensors on rods of 12 mm, clamp-on design up to 4 mm wall thickness • Material: Steel • Details: Aluminum (clamp bar), stainless steel (bracket) • Items supplied: Clamp bar mounting and clamp function, mounting bracket, mounting hardware 	BEF-KHS-IS12G6	2086865
	<ul style="list-style-type: none"> • Description: Mounting bracket for wall mounting • Material: Stainless steel • Details: Stainless steel • Items supplied: Mounting hardware included • Suitable for: W8, W8G, W8 Laser, W8 Inox, G6, G6 Inox, W100 Laser, W100-2, KTM Core, KTM Prime, CSM, LUTM, W4S 	BEF-W100-A	5311520
	<ul style="list-style-type: none"> • Material: Stainless steel • Details: Stainless steel (1.4301) • Suitable for: W4S, W4S 	BEF-WN-G6	2062909

	Brief description	Type	part no.
connectors and cables			
	<ul style="list-style-type: none"> • Description: Unshielded • Connection type head A: Male connector, M8, 4-pin, straight, A-coded • Connection systems: Screw-type terminals • Permitted cross-section: 0.14 mm² ... 0.5 mm² 	STE-0804-G	6037323
	<ul style="list-style-type: none"> • Description: Sensor/actuator cable, unshielded • Connection type head A: Female connector, M8, 4-pin, straight, A-coded • Connection type head B: Flying leads • Signal type: Sensor/actuator cable • Cable: 5 m, 4-wire, PUR, halogen-free • Application: Drag chain operation, Zones with oils and lubricants, Robot, Drag chain operation 	YF8U14-050UA3XLEAX	2094792
	<ul style="list-style-type: none"> • Description: Sensor/actuator cable, unshielded • Connection type head A: Female connector, M8, 4-pin, straight, A-coded • Connection type head B: Flying leads • Signal type: Sensor/actuator cable • Cable: 5 m, 4-wire, PVC • Application: Uncontaminated zones, Zones with chemicals 	YF8U14-050VA3XLEAX	2095889

SICK AT A GLANCE

SICK is one of the leading manufacturers of intelligent sensors and sensor solutions for industrial applications. A unique range of products and services creates the perfect basis for controlling processes securely and efficiently, protecting individuals from accidents and preventing damage to the environment.

We have extensive experience in a wide range of industries and understand their processes and requirements. With intelligent sensors, we can deliver exactly what our customers need. In application centers in Europe, Asia and North America, system solutions are tested and optimized in accordance with customer specifications. All this makes us a reliable supplier and development partner.

Comprehensive services complete our offering: SICK LifeTime Services provide support throughout the machine life cycle and ensure safety and productivity.

For us, that is “Sensor Intelligence.”

WORLDWIDE PRESENCE:

Contacts and other locations –www.sick.com