



GL2S-P0311S08

G2

PHOTOELECTRIC SENSORS

SICK
Sensor Intelligence.



Illustration may differ



Ordering information

Type	part no.
GL2S-P0311S08	1109135

Other models and accessories → www.sick.com/G2

Detailed technical data

Features

Functional principle	Photoelectric retro-reflective sensor
Functional principle detail	With minimum distance to reflector (dual lens system)
Dimensions (W x H x D)	7.7 mm x 21.8 mm x 13.5 mm
Housing design (light emission)	Rectangular
Sensing range max.	0.02 m ... 3 m ¹⁾
Sensing range	0.03 m ... 2.5 m ¹⁾
Type of light	Visible red light
Light source	PinPoint LED ²⁾
Light spot size (distance)	Ø 11 mm (250 mm)
Wave length	640 nm
Adjustment	None

¹⁾ Reflector PL40A.

²⁾ Average service life: 100,000 h at T_J = +25 °C.

Mechanics/electronics

Supply voltage U_B	10 V DC ... 30 V DC ¹⁾
-------------------------------------	-----------------------------------

¹⁾ Limit values when operated in short-circuit protected network: max. 8 A.

²⁾ May not fall below or exceed U_y tolerances.

³⁾ Without load.

⁴⁾ Signal transit time with resistive load.

⁵⁾ With light/dark ratio 1:1.

⁶⁾ Do not bend below 0 °C.

⁷⁾ A = V_S connections reverse-polarity protected.

⁸⁾ C = interference suppression.

⁹⁾ D = outputs overcurrent and short-circuit protected.

Ripple	< 5 V _{pp} ²⁾
Current consumption	20 mA ³⁾
Switching output	PNP
Switching mode	Light switching
Output current I_{max.}	≤ 50 mA
Response time	< 0.6 ms ⁴⁾
Switching frequency	800 Hz ⁵⁾
Connection type	Cable with MOLEX-connector 43020-0409, 200 mm ⁶⁾
Cable material	Plastic, PVC
Circuit protection	A ⁷⁾ C ⁸⁾ D ⁹⁾
Weight	17.5 g
Polarisation filter	✓
Housing material	Plastic, ABS
Optics material	Plastic, PMMA
Enclosure rating	IP67
Ambient operating temperature	-30 °C ... +50 °C
Ambient temperature, storage	-40 °C ... +75 °C
UL File No.	NRKH.E181493

1) Limit values when operated in short-circuit protected network: max. 8 A.

2) May not fall below or exceed U_y tolerances.

3) Without load.

4) Signal transit time with resistive load.

5) With light/dark ratio 1:1.

6) Do not bend below 0 °C.

7) A = V_S connections reverse-polarity protected.

8) C = interference suppression.

9) D = outputs overcurrent and short-circuit protected.

Safety-related parameters

MTTF_D	3,487 years
DC_{avg}	0 %

Certificates

EU declaration of conformity	✓
UK declaration of conformity	✓
ACMA declaration of conformity	✓
Moroccan declaration of conformity	✓
China RoHS	✓
cULus certificate	✓
Photobiological safety (DIN EN 62471) certificate	✓

Classifications

ECLASS 5.0	27270902
-------------------	----------

ECLASS 5.1.4	27270902
ECLASS 6.0	27270902
ECLASS 6.2	27270902
ECLASS 7.0	27270902
ECLASS 8.0	27270902
ECLASS 8.1	27270902
ECLASS 9.0	27270902
ECLASS 10.0	27270902
ECLASS 11.0	27270902
ECLASS 12.0	27270902
ETIM 5.0	EC002717
ETIM 6.0	EC002717
ETIM 7.0	EC002717
ETIM 8.0	EC002717
UNSPSC 16.0901	39121528

Connection diagram Cd-045

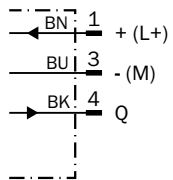

Characteristic curve GL2S

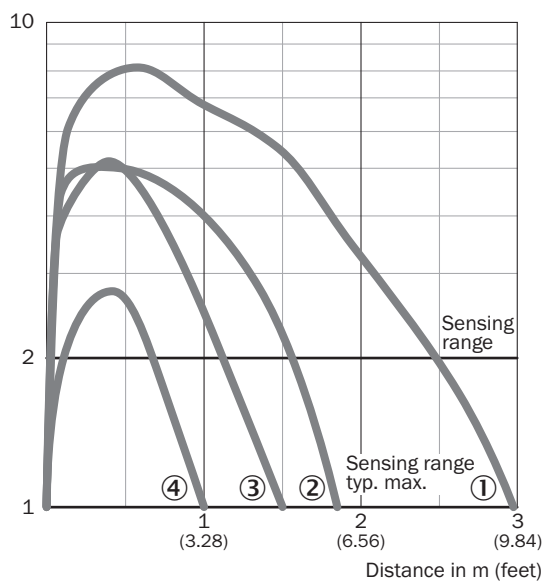

- ① Reflector PL40A
- ② Reflector PL20A

- ③ PL10F reflector
- ④ Reflective tape IREF6000 (REF-IRF-56)

Light spot size GL2S

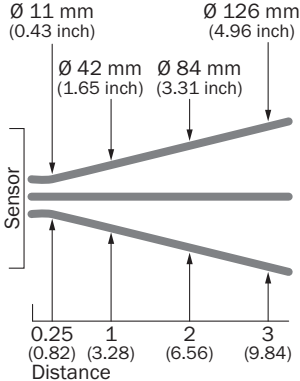

Sensing range diagram GL2S

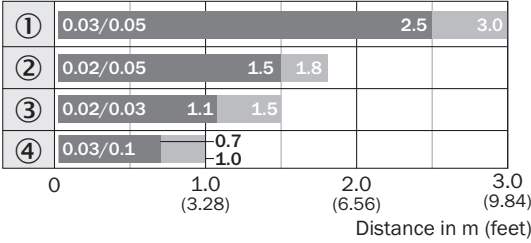

■ Sensing range ■ Sensing range typ. max.

- ① Reflector PL40A
- ② Reflector PL20A
- ③ PL10F reflector
- ④ Reflective tape IREF6000 (REF-IRF-56)

Dimensional drawing GL2S

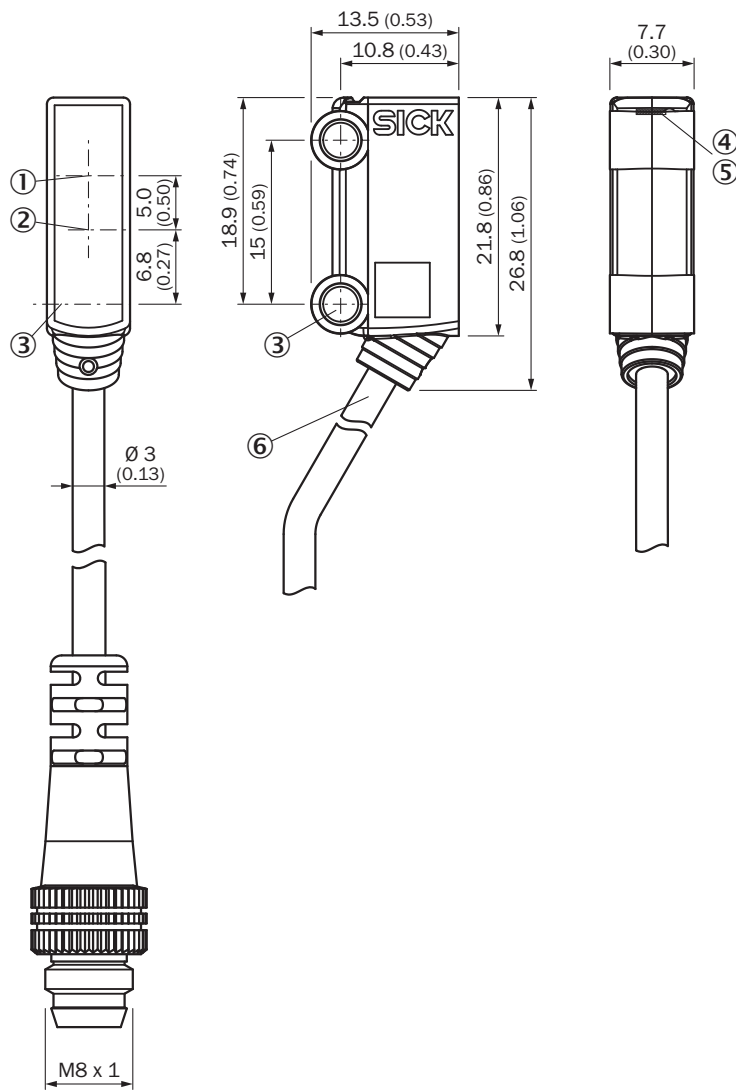





Dimensions in mm (inch)

- ① optical axis, receiver
- ② optical axis, sender
- ③ Mounting hole, $\varnothing 3.2$ mm
- ④ LED indicator green: Supply voltage active
- ⑤ LED indicator yellow: Status of received light beam
- ⑥ Connection

Recommended accessories

Other models and accessories → www.sick.com/G2

	Brief description	Type	part no.
Mounting systems			
	<ul style="list-style-type: none"> Description: Mounting bracket for floor mounting Material: Steel Details: Steel, zinc coated Items supplied: Without mounting hardware Suitable for: W2S-2 	BEF-W2S-A	4034748
reflectors and optics			
	<ul style="list-style-type: none"> Description: Fine triple reflector, screw connection, suitable for laser sensors Dimensions: 20 mm 32 mm Ambient operating temperature: -30 °C ... +65 °C 	PL10F	5311210
connectors and cables			
	<ul style="list-style-type: none"> Connection type head A: Female connector, M8, 3-pin, straight, A-coded Connection type head B: Flying leads Signal type: Sensor/actuator cable Cable: 5 m, 3-wire, PVC Description: Sensor/actuator cable, unshielded Application: Uncontaminated zones, Zones with chemicals 	YF8U13-050VA1XLEAX	2095884
	<ul style="list-style-type: none"> Connection type head A: Female connector, M8, 3-pin, straight, A-coded Connection type head B: Flying leads Signal type: Sensor/actuator cable Cable: 5 m, 3-wire, PUR, halogen-free Description: Sensor/actuator cable, unshielded Application: Drag chain operation, Zones with oils and lubricants, Robot, Drag chain operation 	YF8U13-050UA1XLEAX	2094788
	<ul style="list-style-type: none"> Description: Unshielded Connection type head A: Male connector, M8, 3-pin, straight, A-coded Connection systems: Screw-type terminals Permitted cross-section: 0.14 mm² ... 0.5 mm² 	STE-0803-G	6037322

SICK AT A GLANCE

SICK is one of the leading manufacturers of intelligent sensors and sensor solutions for industrial applications. A unique range of products and services creates the perfect basis for controlling processes securely and efficiently, protecting individuals from accidents and preventing damage to the environment.

We have extensive experience in a wide range of industries and understand their processes and requirements. With intelligent sensors, we can deliver exactly what our customers need. In application centers in Europe, Asia and North America, system solutions are tested and optimized in accordance with customer specifications. All this makes us a reliable supplier and development partner.

Comprehensive services complete our offering: SICK LifeTime Services provide support throughout the machine life cycle and ensure safety and productivity.

For us, that is “Sensor Intelligence.”

WORLDWIDE PRESENCE:

Contacts and other locations –www.sick.com