

WFE-080060B337

WFE

FORK SENSORS

SICK
Sensor Intelligence.

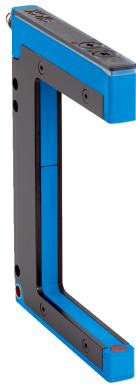

Illustration may differ



Ordering information

Type	part no.
WFE-080060B337	1106556

Other models and accessories → www.sick.com/WFE

Detailed technical data

Features

Dimensions (W x H x D)	10 mm x 109.3 mm x 78.5 mm
Fork width	80 mm
Fork depth	60 mm
Light source	LED, visible red light
Minimum detectable object (MDO)	0.5 mm
Display	LED indicator green: power on LED indicator, yellow: Status switching output Q
Adjustment	Potentiometer, light/dark switching
Safety-related parameters	
	MTTF _D 1,217 years
	DC _{avg} 0 %
	T _M (mission time) 20 years

Electronics

Supply voltage	10 V DC ... 30 V DC
Ripple	< 10 %
Current consumption	< 30 mA ¹⁾
Initialization time	100 ms
Switching frequency	5 kHz
Response time	≤ 100 μs
Stability of response time	± 20 μs
Switching output	Push-pull: PNP/NPN
Switching output (voltage)	Push-pull: PNP/NPN High = U _V - < 2 V/Low: ≤ 2 V

¹⁾ Without load.

Switching mode	Light/dark switching
Switching output hysteresis	< 0.1 mm
Output current I_{max.}	100 mA
Protection class	III
Circuit protection	U _V connections, reverse polarity protected Output Q short-circuit protected Interference pulse suppression
Connection type	Connector M8, 3-pin
Pinouts	
	BN 1 + (L+)
	BU 3 - (M)
	BK 4 Q

¹⁾ Without load.

Mechanics

Housing material	ABS Coated carbon steel (frame)
Weight	Approx. 120 g

Ambient data

Ambient operating temperature	-20 °C ... +60 °C
Ambient temperature, storage	-40 °C ... +75 °C
Ambient light immunity	≤ 10,000 lx
Shock load	According to IEC 60068-2-27 (30 g/11 ms)
Enclosure rating	IP67
UL File No.	NRKH.E348498 & NRKH7.E348498

Certificates

EU declaration of conformity	✓
UK declaration of conformity	✓
ACMA declaration of conformity	✓
Moroccan declaration of conformity	✓
China RoHS	✓
cULus certificate	✓
Photobiological safety (IEC EN 62471)	✓

Classifications

ECLASS 5.0	27270909
ECLASS 5.1.4	27270909
ECLASS 6.0	27270909
ECLASS 6.2	27270909
ECLASS 7.0	27270909
ECLASS 8.0	27270909
ECLASS 8.1	27270909

ECLASS 9.0	27270909
ECLASS 10.0	27270909
ECLASS 11.0	27270909
ECLASS 12.0	27270909
ETIM 5.0	EC002720
ETIM 6.0	EC002720
ETIM 7.0	EC002720
ETIM 8.0	EC002720
UNSPSC 16.0901	39121528

Dimensional drawing WFE-xxxxxxx3xx

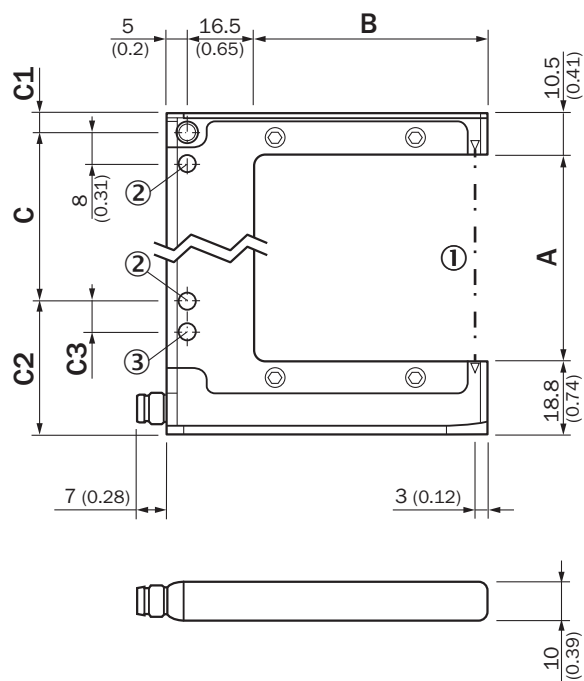

Dimensions in mm (inch)

① Optical axis

② Mounting hole, \varnothing 4.3 mm

③ only WFE-050/-080/-120/-180

Type	A (fork width)	B (fork depth)	C	C1	C2	C3
WFE-030040xxxx	30 (1.18)	39 (1.54)	30 (1.18)	5 (0.2)	24.3 (0.96)	-
WFE-050060xxxx	50 (1.97)	57 (2.25)	40 (1.57)	5 (0.2)	34.3 (1.35)	8 (0.31)
WFE-080060xxxx	80 (3.15)	57 (2.24)	70 (2.76)	5 (0.2)	34.3 (1.35)	8 (0.31)
WFE-120120xxxx	120 (4.72)	121.5 (4.78)	100 (3.94)	15.5 (0.61)	33.8 (1.33)	10 (0.39)
WFE-180120xxxx	180 (7.09)	121.5 (4.78)	152 (5.98)	20.5 (0.81)	36.8 (1.45)	8 (0.31)

Pinouts, see table Technical data: Electronics

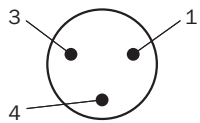

Connector M8, 3-pin

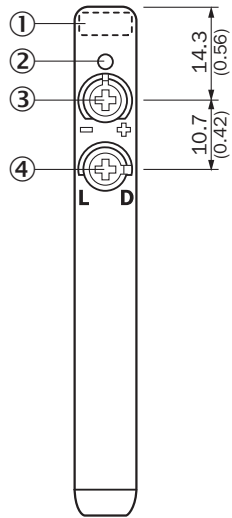

Adjustments WFE-xxxxxxx7



- ① Status indicator LED, yellow: Status switching output
- ② LED indicator green: power
- ③ Potentiometer for sensitivity adjustment
- ④ Light/ dark rotary switch: L = light switching, D = dark switching

Recommended accessories

Other models and accessories → www.sick.com/WFE

	Brief description	Type	part no.
connectors and cables			
	<ul style="list-style-type: none"> • Description: Unshielded • Connection type head A: Female connector, M8, 3-pin, straight, A-coded • Connection systems: Screw-type terminals • Permitted cross-section: 0.14 mm² ... 0.5 mm² 	DOS-0803-G	7902077
	<ul style="list-style-type: none"> • Description: Unshielded • Connection type head A: Male connector, M8, 3-pin, straight, A-coded • Connection systems: Screw-type terminals • Permitted cross-section: 0.14 mm² ... 0.5 mm² 	STE-0803-G	6037322
	<ul style="list-style-type: none"> • Description: Sensor/actuator cable, unshielded • Connection type head A: Female connector, M8, 3-pin, straight, A-coded • Connection type head B: Flying leads • Signal type: Sensor/actuator cable • Cable: 5 m, 3-wire, PVC • Application: Uncontaminated zones, Zones with chemicals 	YF8U13-050VA1XLEAX	2095884

SICK AT A GLANCE

SICK is one of the leading manufacturers of intelligent sensors and sensor solutions for industrial applications. A unique range of products and services creates the perfect basis for controlling processes securely and efficiently, protecting individuals from accidents and preventing damage to the environment.

We have extensive experience in a wide range of industries and understand their processes and requirements. With intelligent sensors, we can deliver exactly what our customers need. In application centers in Europe, Asia and North America, system solutions are tested and optimized in accordance with customer specifications. All this makes us a reliable supplier and development partner.

Comprehensive services complete our offering: SICK LifeTime Services provide support throughout the machine life cycle and ensure safety and productivity.

For us, that is “Sensor Intelligence.”

WORLDWIDE PRESENCE:

Contacts and other locations –www.sick.com