



V3DU3-020RM21A

Ruler3000

3D MACHINE VISION

SICK
Sensor Intelligence.



Ordering information

Type	part no.
V3DU3-020RM21A	1106166

Other models and accessories → www.sick.com/Ruler3000



Detailed technical data

Features

Technology	3D laser triangulation
Streaming	✓
Pre-calibrated	✓
Shutter technology	Global-Shutter
Working range	245.5 mm ... 370.5 mm
Example field of view	190 mm x 50 mm
Exposure mode	Linear HDR
Illumination	Integrated
Illumination color	Red, laser, Visible, 660 nm, ± 15 nm
Laser class	2 (EN 60825-1:2014+A11:2021; IEC 60825-1:2014, Complies with the FDA performance requirements for laser products except for conformance with IEC 60825-1 Ed.3., as described in Laser Notice 56 dated May 8, 2019.)
Data synchronization	Free running, encoder triggered, external triggering
3D measurement	✓
Scatter measurement	✓
Reflectance measurement	✓
Ambient light suppression	✓ ¹⁾
Scheimpflug adapter, integrated	✓
Width at minimum operating distance	155 mm
Width at maximum operating distance	220 mm
Maximum height range	125 mm

¹⁾ Red bandpass filter.

Task	Detecting - Standard objects Detecting - Level Measuring - Dimension, contour and volume Monitoring and controlling - Quality Determining position - 3D position determination
-------------	--

¹⁾ Red bandpass filter.

Mechanics/electronics

Connection type	Voltage – I/O: M12, 17-pin male connector Gigabit Ethernet: M12, 8-pin socket, X-coded
Connector material	M12: Nickel-coated brass
Supply voltage	24 V DC, ± 10 %
Ripple	< 5 V _{pp}
Power consumption	≤ 12 W
Current consumption	≤ 1.5 A
Enclosure rating	IP65 IP67
Protection class	III
Housing material	Aluminum
Housing color	Blue
Window material	Float glass, anti-reflective coated
Weight	1.8 kg
Dimensions (L x W x H)	245 mm x 65 mm x 108 mm

Performance

Image sensor	CMOS sensor from SICK with ROCC technology, M30
Scan/frame rate	46,000 3D profiles/s, In reduced ROI 7,000 3D profiles/s, full format
Data points/profile	3,200
Repeatability	3.9 μm ¹⁾
Typical resolution	Z resolution (height): 8 μm ... 16 μm, X resolution (width): 65 μm ... 92 μm

¹⁾ Height values measured for different positions in the field of view. 20 measurements are performed at each position. The repeatability value is the 3-fold of the standard deviation (3 σ) for all measurements at all positions.

Interfaces

Ethernet	✓, UDP/IP
Remark	GigE Vision Standard
Data transmission rate	≤ 1 Gbit/s
Configuration software	Stream Setup
Operating system	Windows 10
Application programming interface (API)	GenAPI, GenTL, Proprietary SICK GenIStream
Inputs/outputs	4 x HIGH = 10 V ... 28.8 V, configurable
Encoder interface	RS-422 5 V, 2 x HTL single-ended

Ambient data

Shock load	15 g, 3 cycles per axis
-------------------	-------------------------

¹⁾ Non-condensing.

Vibration load	5 g, 10 Hz ... 150 Hz (EN 60068-2-6)
Ambient operating temperature	0 °C ... +50 °C ¹⁾
Storage temperature	-30 °C ... +70 °C ¹⁾

¹⁾ Non-condensing.

Certificates

EU declaration of conformity	✓
UK declaration of conformity	✓
ACMA declaration of conformity	✓
China RoHS	✓
EAC certificate / DoC	✓
cTUVus certificate	✓
Information according to Art. 3 of Data Act (Regulation EU 2023/2854)	✓
GigE Vision	✓
GenICam	✓

Classifications

ECLASS 5.0	27310205
ECLASS 5.1.4	27310205
ECLASS 6.0	27310205
ECLASS 6.2	27310205
ECLASS 7.0	27310205
ECLASS 8.0	27310205
ECLASS 8.1	27310205
ECLASS 9.0	27310205
ECLASS 10.0	27310205
ECLASS 11.0	27310205
ECLASS 12.0	27310205
ETIM 5.0	EC001820
ETIM 6.0	EC001820
ETIM 7.0	EC001820
ETIM 8.0	EC001820
UNSPSC 16.0901	43211731

Dimensional drawing

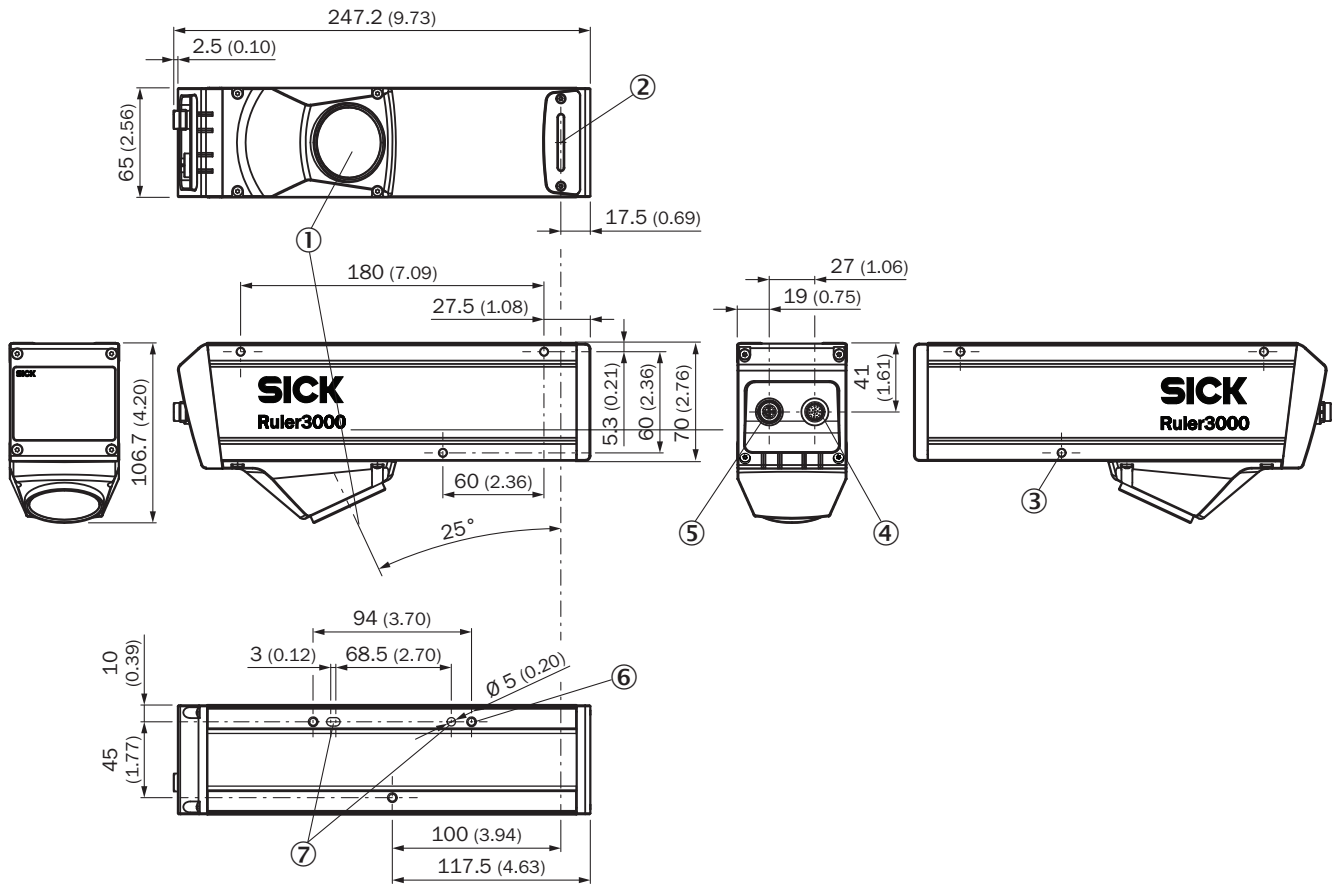

Dimensions in mm (inch)

- ① Optical receiver (center)
- ② Optical sender (center)
- ③ Threaded mounting hole (M5, 12 mm deep) with through hole ($\varnothing 4.2$ mm)
- ④ Power I/O connection
- ⑤ Gigabit Ethernet connection (GbE)
- ⑥ Threaded mounting hole (M5, 9 mm deep)
- ⑦ Position and alignment hole for locating pins ($\varnothing 5$ mm)

Field of view

Ruler3020

Guaranteed field of view in mm

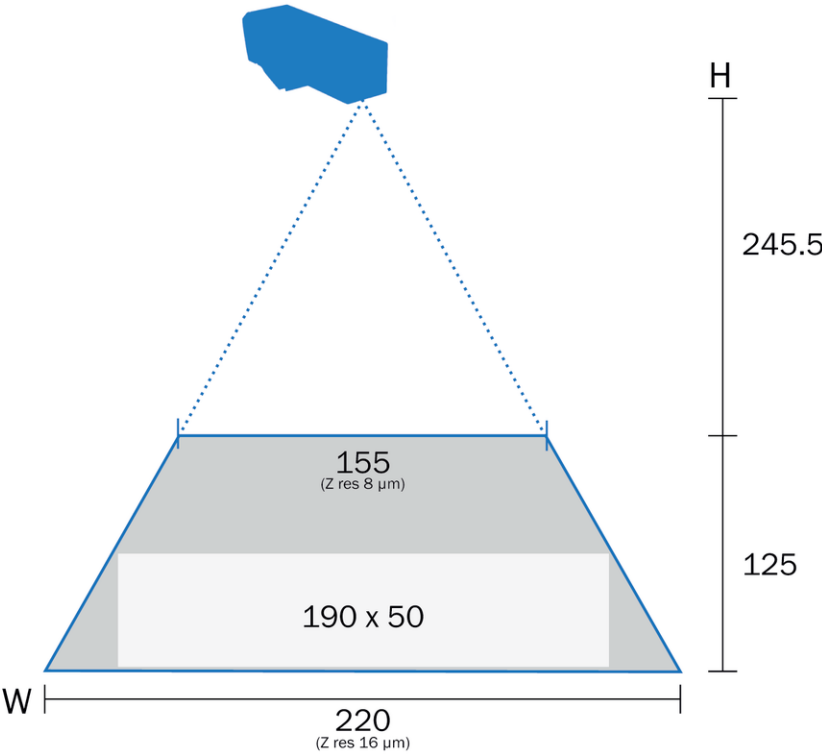

Characteristic curve Width of the field of view via the Z position

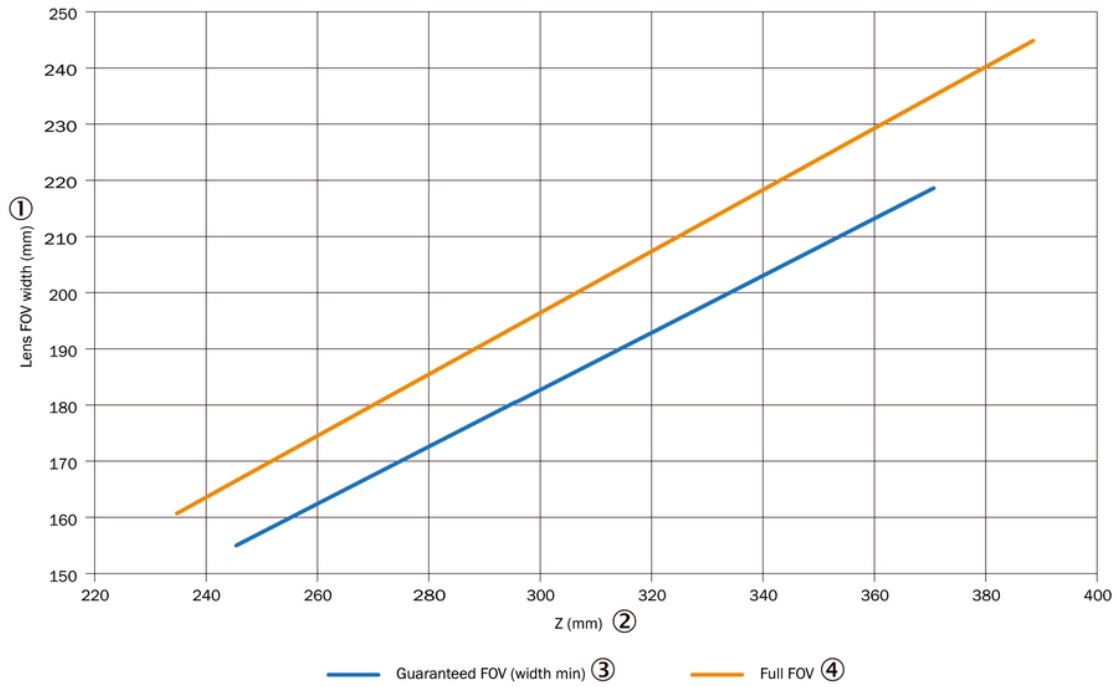

Characteristic curve Z resolution via Z position

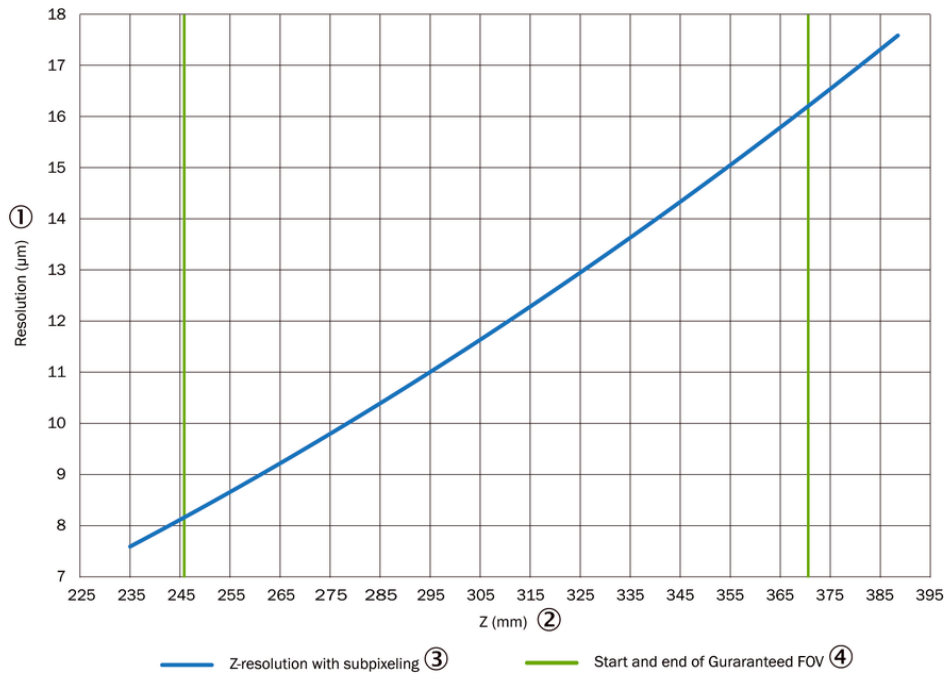

Characteristic curve X resolution via Z position

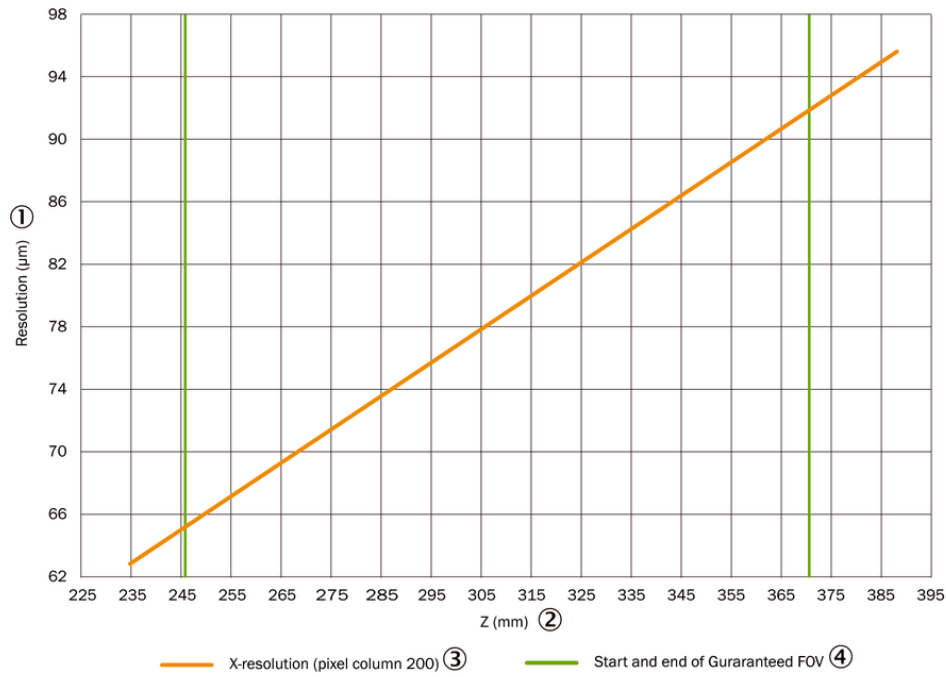

Characteristic curve

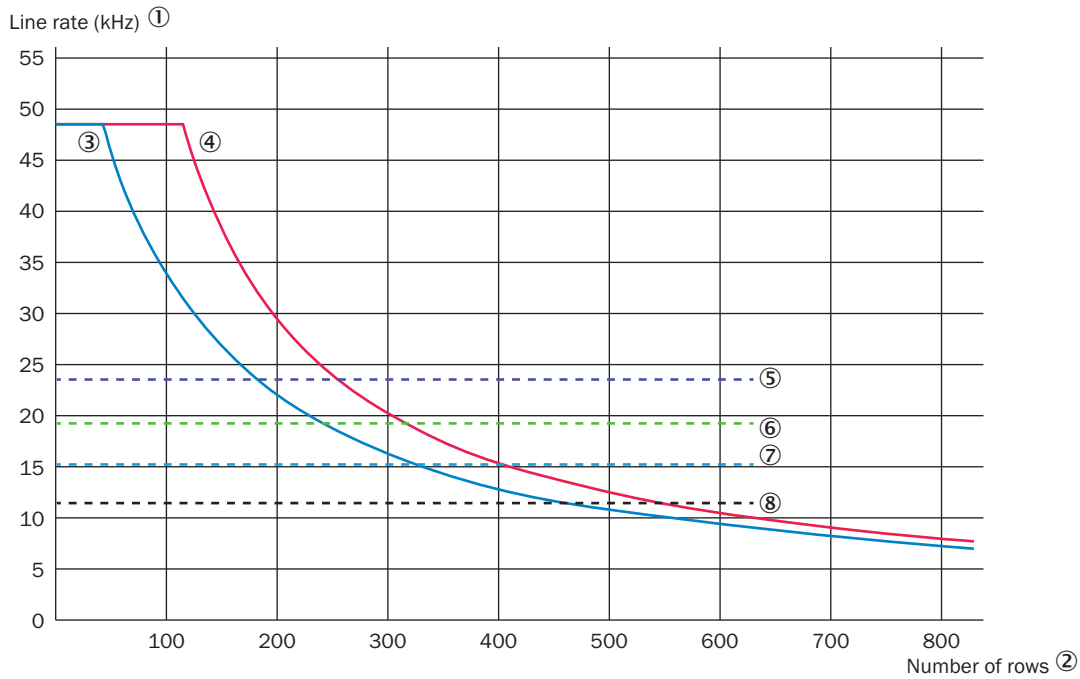





The maximum line rate is based on the number of sensor lines used

- ① Line rate (kHz)
- ② Number of lines
- ③ Ruler3000 with activated HDR

- ④ Ruler3000 without activated HDR
- ⑤ Bandwidth limit for image width 2,560, height range only
- ⑥ Bandwidth limit for image width 3,072, height range only
- ⑦ Bandwidth limit for image width 2,560, height range and reflectance
- ⑧ Bandwidth limit for image width 3,072, height range and reflectance

Recommended accessories

Other models and accessories → www.sick.com/Ruler3000

	Brief description	Type	part no.
connectors and cables			
	<ul style="list-style-type: none"> Description: Sensor/actuator cable, twisted pair, shielded Connection type head A: Female connector, M12, 17-pin, straight, A-coded Connection type head B: Flying leads Signal type: Sensor/actuator cable Cable: 3 m, 17-wire, PUR Application: Zones with oils and lubricants, Zones with oils and lubricants, Robot, Drag chain operation 	YF2A2D-030U-V1XLEAX	6042772
	<ul style="list-style-type: none"> Connection type head A: Male connector, M12, 8-pin, straight, X-coded Connection type head B: Male connector, RJ45, 8-pin, straight Signal type: Ethernet, Gigabit Ethernet Cable: 2 m, 8-wire, PUR, halogen-free Description: Ethernet, shielded, Gigabit Ethernet Application: Zones with oils and lubricants 	YM2X18-020EG1M-RJA8	2106258
	<ul style="list-style-type: none"> Connection type head A: Male connector, M12, 8-pin, straight, X-coded Connection type head B: Male connector, RJ45, 8-pin, straight Signal type: Ethernet, Gigabit Ethernet Cable: 3 m, 8-wire, PUR, halogen-free Description: Ethernet, shielded, Gigabit Ethernet Application: Zones with oils and lubricants 	YM2X18-030EG1M-RJA8	2145693
Mounting systems			
	<ul style="list-style-type: none"> Description: Mounting bracket set consisting of mounting bracket, cooling plate, includes angle display for setting the tilt angle Suitable for: Lector63x, Inspector63x, Lector83x – up to 40 °C ambient operating temperature, Insepctor83x – up to 40 °C ambient operating temperature, Lector83x – up to 40 °C ambient operating temperature, Insepctor83x – up to 40 °C ambient operating temperature, Lector63x, Inspector63x 	Mounting bracket set with inclination angle -40° - 40°	2076735

SICK AT A GLANCE

SICK is one of the leading manufacturers of intelligent sensors and sensor solutions for industrial applications. A unique range of products and services creates the perfect basis for controlling processes securely and efficiently, protecting individuals from accidents and preventing damage to the environment.

We have extensive experience in a wide range of industries and understand their processes and requirements. With intelligent sensors, we can deliver exactly what our customers need. In application centers in Europe, Asia and North America, system solutions are tested and optimized in accordance with customer specifications. All this makes us a reliable supplier and development partner.

Comprehensive services complete our offering: SICK LifeTime Services provide support throughout the machine life cycle and ensure safety and productivity.

For us, that is “Sensor Intelligence.”

WORLDWIDE PRESENCE:

Contacts and other locations –www.sick.com