



# C4P-EX12031C00

deTec

SAFETY LIGHT CURTAINS

**SICK**  
Sensor Intelligence.



### Ordering information

Type	part no.
C4P-EX12031C00	1106058

Other models and accessories → [www.sick.com/deTec](http://www.sick.com/deTec)

Illustration may differ



### Detailed technical data

#### Features

<b>Product version</b>	deTec4 Ex II 3GD
<b>Application</b>	Explosive areas
<b>Ex-approvals</b>	ATEX for gas: II 3G Ex ec op is IIC T4 Gc ATEX for dust: II 3D Ex tc IIIC T135°C Dc
<b>System part</b>	Receiver
<b>Resolution</b>	30 mm
<b>Scanning range</b>	30 m
<b>Protective field height</b>	1,200 mm
<b>Response time</b>	12 ms (Uncoded) 20 ms (code 1 or code 2)
<b>No blind zones</b>	Yes
<b>Synchronization</b>	Optical synchronization
<b>Items supplied</b>	Receiver Test rod with diameter corresponding to the resolution of the safety light curtain “Notes for explosion protection” label(s) Safety instruction Mounting instructions Operating instructions for download

#### Safety-related parameters

<b>Type</b>	Type 4 (IEC 61496-1)
<b>Safety integrity level</b>	SIL 3 (IEC 61508)
<b>Category</b>	Category 4 (ISO 13849-1)
<b>Performance level</b>	PL e (ISO 13849-1)
<b>PFH<sub>D</sub> (mean probability of a dangerous failure per hour)</b>	

Single device	$15.3 \times 10^{-9}$
Cascade with one guest	$30.5 \times 10^{-9}$
Cascade with two guest devices	$45.6 \times 10^{-9}$
<b>T<sub>M</sub> (mission time)</b>	20 years (ISO 13849-1)
<b>Safe state in the event of a fault</b>	At least one OSSD is in the OFF state.

## Functions

<b>Protective operation</b>	✓
<b>Automatic calibration of the protective field width</b>	✓
<b>Beam coding</b>	✓
<b>Restart interlock</b>	✓
<b>External device monitoring (EDM)</b>	✓
<b>Cascading</b>	✓
<b>Smart presence detection</b>	✓
<b>Reduced resolution</b>	✓
<b>Dynamic protective field width during operation</b>	✓
<b>Differentiation between person and material</b>	
2-signal muting	✓

## Interfaces

<b>System connection</b>	Depending on system plug (M12 male connector, 5-pin or 8-pin)
<b>Extension connection</b>	Depending on system plug (without extension connection or with M12 female connector, 5-pin)
<b>Configuration method</b>	DIP switch on system plug
<b>Display elements</b>	LEDs
<b>Display of the synchronization status of the upper and lower beams</b>	✓
<b>Application diagnostic output (ADO)</b>	✓
<b>IO-Link</b>	✓
<b>Near Field Communication (NFC)</b>	✓

## Electronics

<b>Protection class</b>	III (IEC 61140)
<b>Supply voltage V<sub>S</sub></b>	24 V DC (19.2 V ... 28.8 V)
<b>Ripple</b>	≤ 10 %
<b>Power consumption typical</b>	3.63 W (DC)
<b>Output signal switching devices (OSSDs)</b>	
Type of output	2 PNP semiconductors, short-circuit protected, cross-circuit monitored <sup>1)</sup>
ON state, switching voltage HIGH	24 V DC (V <sub>S</sub> - 2.25 V DC ... V <sub>S</sub> )
OFF state, switching voltage LOW	≤ 2 V DC
Current-carrying capacity per OSSD	≤ 500 mA

<sup>1)</sup> Applies to the voltage range between -30 V and +30 V.

Application diagnostic output (ADO)	
Type of output	PNP semiconductor, short-circuit protected <sup>1)</sup>
Output voltage HIGH (active)	$\geq V_s - 3 \text{ V}$
Output voltage LOW (deactivated)	High resistance
Output current HIGH (active)	$\leq 100 \text{ mA}$

<sup>1)</sup> Applies to the voltage range between -30 V and +30 V.

## Mechanics

<b>Dimensions</b>	See dimensional drawing
<b>Housing material</b>	Aluminum extruded profile

## Ambient data

<b>Enclosure rating</b>	IP65 (IEC 60529)
<b>Ambient operating temperature</b>	0 °C ... +55 °C
<b>Storage temperature</b>	-30 °C ... +70 °C
<b>Air humidity</b>	15 % ... 95 %, Non-condensing
<b>Vibration resistance</b>	5 ... 150 Hz, 3,5 mm / 1 g (EN 60068-2-6)
<b>Shock resistance</b>	15 g / 6 ms (EN 60068-2-27)
<b>Class</b>	3M4 (IEC TR 60721-4-3)

## Certificates

<b>EU declaration of conformity</b>	✓
<b>UK declaration of conformity</b>	✓
<b>ACMA declaration of conformity</b>	✓
<b>Moroccan declaration of conformity</b>	✓
<b>China RoHS</b>	✓
<b>CCC certificate</b>	✓
<b>UK-Type-Examination approval</b>	✓
<b>IECEx certificate</b>	✓
<b>ULus approval</b>	✓
<b>cUL approval</b>	✓
<b>Japan Press Safety certificate</b>	✓
<b>EC-Type-Examination approval</b>	✓
<b>China EX Type-Examination certificate</b>	✓
<b>China GB/T certificate</b>	✓
<b>Information according to Art. 3 of Data Act (Regulation EU 2023/2854)</b>	✓

## Classifications

<b>ECLASS 5.0</b>	27272704
<b>ECLASS 5.1.4</b>	27272704
<b>ECLASS 6.0</b>	27272704
<b>ECLASS 6.2</b>	27272704
<b>ECLASS 7.0</b>	27272704
<b>ECLASS 8.0</b>	27272704

<b>ECLASS 8.1</b>	27272704
<b>ECLASS 9.0</b>	27272704
<b>ECLASS 10.0</b>	27272704
<b>ECLASS 11.0</b>	27272704
<b>ECLASS 12.0</b>	27272704
<b>ETIM 5.0</b>	EC002549
<b>ETIM 6.0</b>	EC002549
<b>ETIM 7.0</b>	EC002549
<b>ETIM 8.0</b>	EC002549
<b>UNSPSC 16.0901</b>	46171620

Dimensional drawing

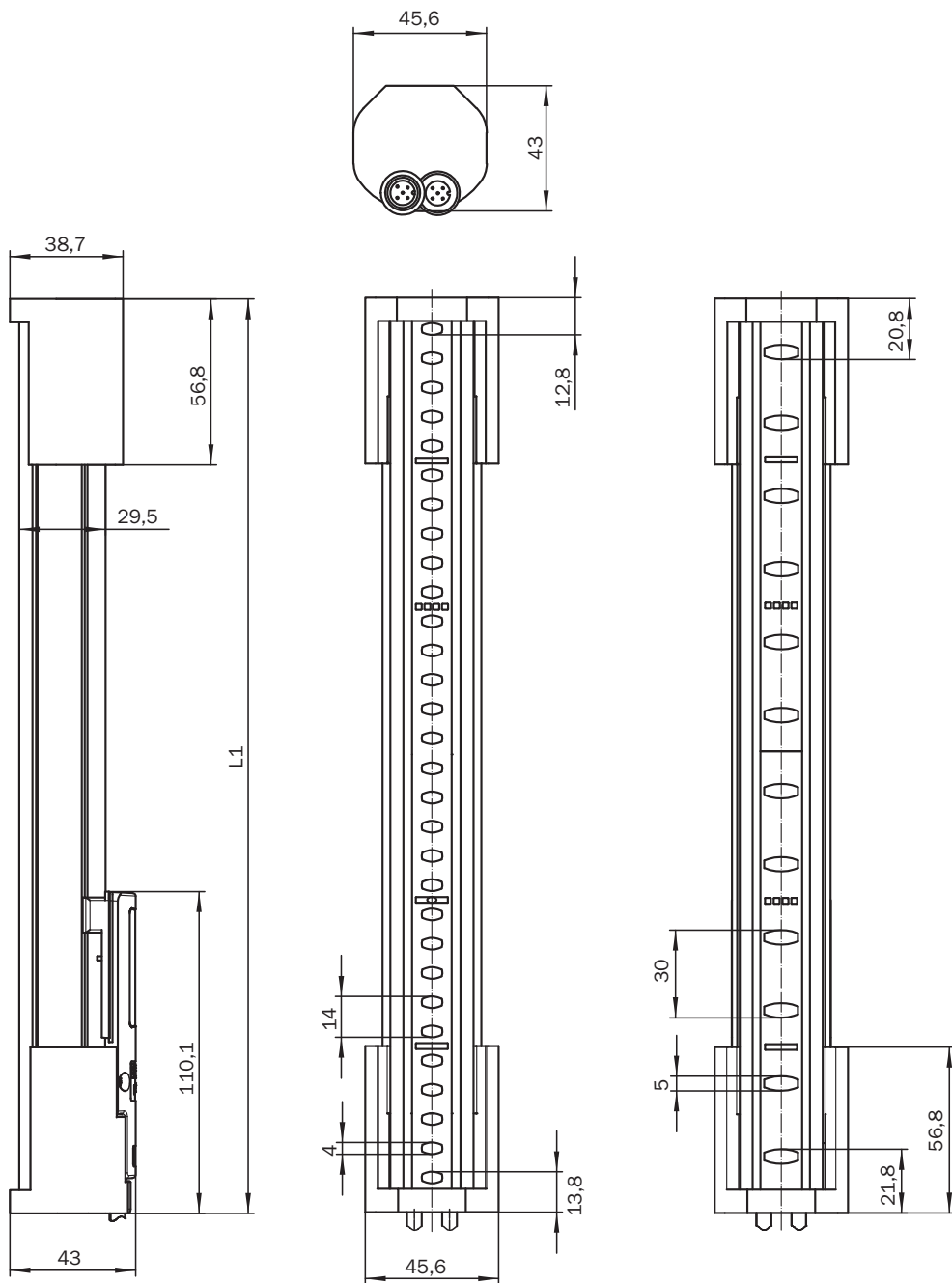

Dimensions in mm (inch)

Protective field height	L1
300	313
450	463
600	613
750	763
900	913
1.050	1.063
1.200	1.213

Protective field height	L1
1.350	1362
1.500	1.512
1.650	1.662
1.800	1.812
1.950	1.962
2.100	2.112

Connection diagram deTec / deTem4 on DMM4, muting, reset, override, operating mode selection

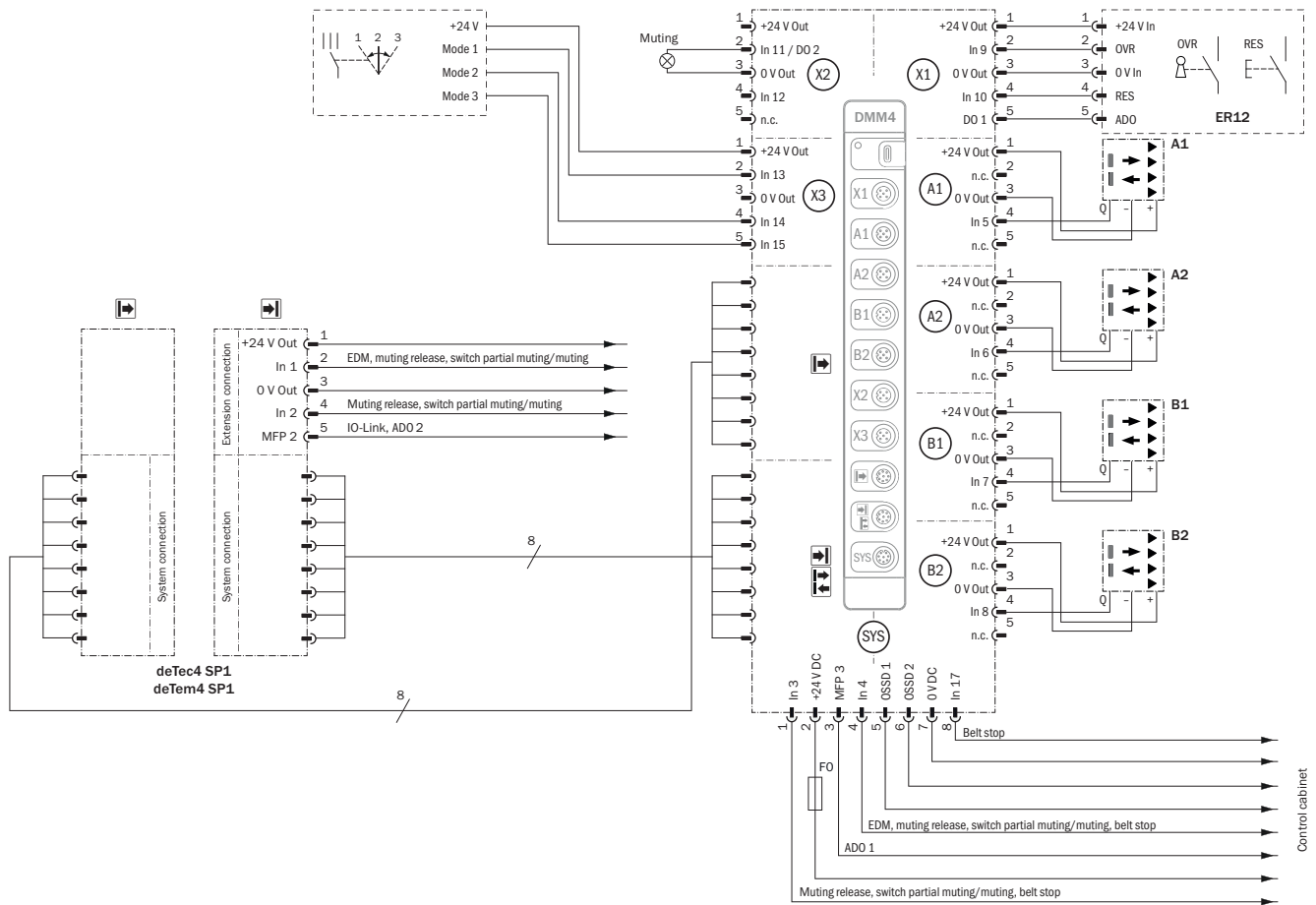

E416642/00/2024-12-20

The requirements in the operating instructions of the devices used must be adhered to.

Connection diagram deTec4 / deTem4 on DMM4, connection example, muting, reset, override, SDI

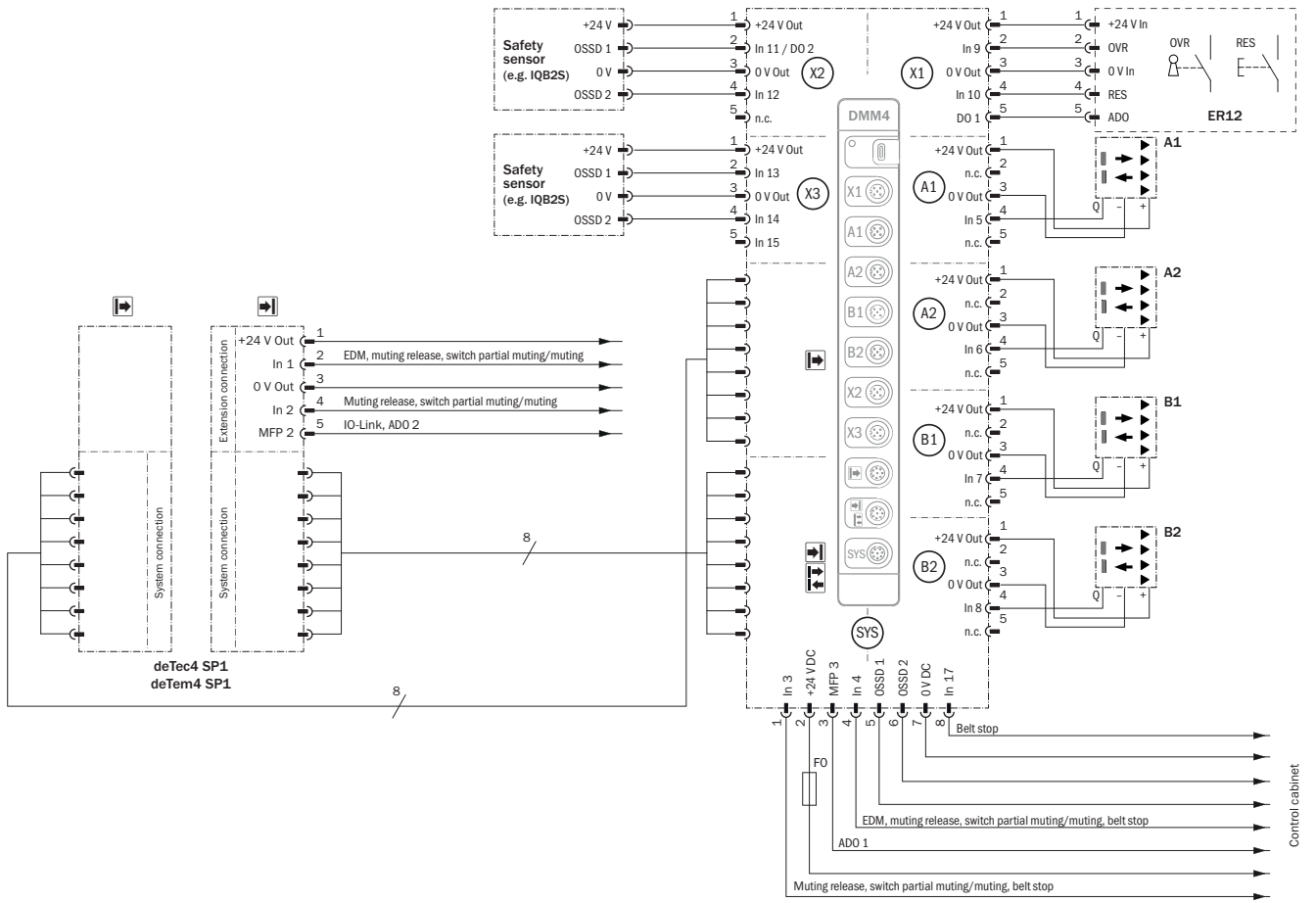





E416641/00/2024-12-20

The requirements in the operating instructions of the devices used must be adhered to.









## Recommended accessories





Other models and accessories → [www.sick.com/deTec](http://www.sick.com/deTec)

	Brief description	Type	part no.
Safety relays			
	<ul style="list-style-type: none"> <li>• <b>Applications:</b> Output expansion module for OSSDs</li> <li>• <b>Compatible sensor types:</b> Safety sensors with OSSDs</li> <li>• <b>Connection type:</b> Front connector with spring terminals</li> <li>• <b>Restart interlock:</b> no</li> <li>• <b>External device monitoring (EDM):</b> Via path</li> <li>• <b>Outputs:</b> 2 enabling current paths (safe), 1 feedback current path (for use as external device monitoring, not safe)</li> <li>• <b>Housing width:</b> 18 mm</li> </ul>	RLY3-OSSD100	1085343
	<ul style="list-style-type: none"> <li>• <b>Applications:</b> Output expansion module for OSSDs</li> <li>• <b>Compatible sensor types:</b> Safety sensors with OSSDs</li> <li>• <b>Connection type:</b> Front connector with spring terminals</li> <li>• <b>Restart interlock:</b> no</li> <li>• <b>External device monitoring (EDM):</b> Via path</li> <li>• <b>Outputs:</b> 4 enabling current paths (safe), 1 feedback current path (for use as external device monitoring, not safe), 1 signaling current path (not safe)</li> <li>• <b>Housing width:</b> 28 mm</li> </ul>	RLY3-OSSD400	1099971
Commissioning aids and test equipment			
	<ul style="list-style-type: none"> <li>• <b>Product:</b> Alignment aids</li> <li>• <b>Dimensions (W x H x L):</b> 19 mm 67.3 mm 66.9 mm</li> <li>• <b>Description:</b> Laser alignment aid for various sensors, laser class 2 (IEC 60825). Do not look into the beam!</li> </ul>	AR60	1015741
	<ul style="list-style-type: none"> <li>• <b>Product:</b> Test equipment</li> <li>• <b>Description:</b> 30 mm diameter, 250 mm length</li> </ul>	Test rod 30 mm	2022602

	Brief description	Type	part no.
connectors and cables			
	<ul style="list-style-type: none"> <li><b>Description:</b> Unshielded</li> <li><b>Connection type head A:</b> Female connector, M12, 5-pin, A-coded</li> <li><b>Connection type head B:</b> Female connector, M12, 5-pin, A-coded</li> <li><b>Connection type head C:</b> Male connector, M12, 5-pin, A-coded</li> </ul>	DSC-1205T000025KMC	6030664
	<ul style="list-style-type: none"> <li><b>Description:</b> Unshielded</li> <li><b>Connection type head A:</b> Female connector, M12, 8-pin, A-coded</li> <li><b>Connection type head B:</b> Female connector, M12, 8-pin, A-coded</li> <li><b>Connection type head C:</b> Male connector, M12, 8-pin, A-coded</li> </ul>	DSC-1208T000025KMC	6058647
	<ul style="list-style-type: none"> <li><b>Description:</b> Sensor/actuator cable, unshielded</li> <li><b>Connection type head A:</b> Female connector, M12, 5-pin, straight, A-coded</li> <li><b>Connection type head B:</b> Male connector, M12, 5-pin, straight, A-coded</li> <li><b>Signal type:</b> Sensor/actuator cable</li> <li><b>Cable:</b> 2 m, 5-wire, PUR, halogen-free</li> <li><b>Application:</b> Drag chain operation, Zones with oils and lubricants, Robot, Drag chain operation</li> </ul>	YF2A15-020UB5M2A15	2096009
	<ul style="list-style-type: none"> <li><b>Description:</b> Sensor/actuator cable, unshielded</li> <li><b>Connection type head A:</b> Female connector, M12, 5-pin, straight, A-coded</li> <li><b>Connection type head B:</b> Male connector, M12, 5-pin, straight, A-coded</li> <li><b>Signal type:</b> Sensor/actuator cable</li> <li><b>Cable:</b> 5 m, 5-wire, PUR, halogen-free</li> <li><b>Application:</b> Drag chain operation, Zones with oils and lubricants, Robot, Drag chain operation</li> </ul>	YF2A15-050UB5M2A15	2096010
	<ul style="list-style-type: none"> <li><b>Description:</b> Sensor/actuator cable, unshielded</li> <li><b>Connection type head A:</b> Female connector, M12, 5-pin, straight, A-coded</li> <li><b>Connection type head B:</b> Male connector, M12, 5-pin, straight, A-coded</li> <li><b>Signal type:</b> Sensor/actuator cable</li> <li><b>Cable:</b> 10 m, 5-wire, PUR, halogen-free</li> <li><b>Application:</b> Drag chain operation, Zones with oils and lubricants, Robot, Drag chain operation</li> </ul>	YF2A15-100UB5M2A15	2096011
	<ul style="list-style-type: none"> <li><b>Description:</b> Sensor/actuator cable, unshielded</li> <li><b>Connection type head A:</b> Female connector, M12, 8-pin, straight, A-coded</li> <li><b>Connection type head B:</b> Male connector, M12, 8-pin, straight, A-coded</li> <li><b>Signal type:</b> Sensor/actuator cable</li> <li><b>Cable:</b> 2 m, 8-wire, PUR, halogen-free</li> <li><b>Application:</b> Drag chain operation, Zones with oils and lubricants, Robot, Drag chain operation</li> </ul>	YF2A18-020UA5M2A18	2096033
	<ul style="list-style-type: none"> <li><b>Description:</b> Sensor/actuator cable, unshielded</li> <li><b>Connection type head A:</b> Female connector, M12, 8-pin, straight, A-coded</li> <li><b>Connection type head B:</b> Male connector, M12, 8-pin, straight, A-coded</li> <li><b>Signal type:</b> Sensor/actuator cable</li> <li><b>Cable:</b> 5 m, 8-wire, PUR, halogen-free</li> <li><b>Application:</b> Drag chain operation, Zones with oils and lubricants, Robot, Drag chain operation</li> </ul>	YF2A18-050UA5M2A18	2096034
	<ul style="list-style-type: none"> <li><b>Description:</b> Sensor/actuator cable, unshielded</li> <li><b>Connection type head A:</b> Female connector, M12, 8-pin, straight, A-coded</li> <li><b>Connection type head B:</b> Male connector, M12, 8-pin, straight, A-coded</li> <li><b>Signal type:</b> Sensor/actuator cable</li> <li><b>Cable:</b> 10 m, 8-wire, PUR, halogen-free</li> <li><b>Application:</b> Drag chain operation, Zones with oils and lubricants, Robot, Drag chain operation</li> </ul>	YF2A18-100UA5M2A18	2096035
		Muting connector	2092758
		IO-Link connector	2092757
	<ul style="list-style-type: none"> <li><b>Description:</b> Sensor/actuator cable, unshielded</li> <li><b>Connection type head A:</b> Female connector, M12, 5-pin, straight, A-coded</li> <li><b>Connection type head B:</b> Flying leads</li> <li><b>Signal type:</b> Sensor/actuator cable</li> <li><b>Cable:</b> 2 m, 5-wire, PUR, halogen-free</li> <li><b>Application:</b> Drag chain operation, Zones with oils and lubricants, Robot, Drag chain operation</li> </ul>	YF2A15-020UB5XLEAX	2095617
	<ul style="list-style-type: none"> <li><b>Description:</b> Sensor/actuator cable, unshielded</li> <li><b>Connection type head A:</b> Female connector, M12, 5-pin, straight, A-coded</li> <li><b>Connection type head B:</b> Flying leads</li> <li><b>Signal type:</b> Sensor/actuator cable</li> <li><b>Cable:</b> 5 m, 5-wire, PUR, halogen-free</li> </ul>	YF2A15-050UB5XLEAX	2095618

	Brief description	Type	part no.
	<ul style="list-style-type: none"> <li><b>Application:</b> Drag chain operation, Zones with oils and lubricants, Robot, Drag chain operation</li> <li><b>Description:</b> Sensor/actuator cable, unshielded</li> <li><b>Connection type head A:</b> Female connector, M12, 5-pin, straight, A-coded</li> <li><b>Connection type head B:</b> Flying leads</li> <li><b>Signal type:</b> Sensor/actuator cable</li> <li><b>Cable:</b> 10 m, 5-wire, PUR, halogen-free</li> <li><b>Application:</b> Drag chain operation, Zones with oils and lubricants, Robot, Drag chain operation</li> </ul>	YF2A15-100UB5XLEAX	2095619
	<ul style="list-style-type: none"> <li><b>Description:</b> Sensor/actuator cable, unshielded</li> <li><b>Connection type head A:</b> Female connector, M12, 8-pin, straight, A-coded</li> <li><b>Connection type head B:</b> Flying leads</li> <li><b>Signal type:</b> Sensor/actuator cable</li> <li><b>Cable:</b> 5 m, 8-wire, PUR, halogen-free</li> <li><b>Application:</b> Drag chain operation, Zones with oils and lubricants, Robot, Drag chain operation</li> </ul>	YF2A18-050UA5XLEAX	2095653
	<ul style="list-style-type: none"> <li><b>Description:</b> Sensor/actuator cable, unshielded</li> <li><b>Connection type head A:</b> Female connector, M12, 8-pin, straight, A-coded</li> <li><b>Connection type head B:</b> Flying leads</li> <li><b>Signal type:</b> Sensor/actuator cable</li> <li><b>Cable:</b> 10 m, 8-wire, PUR, halogen-free</li> <li><b>Application:</b> Drag chain operation, Zones with oils and lubricants, Robot, Drag chain operation</li> </ul>	YF2A18-100UA5XLEAX	2095654
	<ul style="list-style-type: none"> <li><b>Description:</b> Sensor/actuator cable, unshielded</li> <li><b>Connection type head A:</b> Female connector, M12, 8-pin, straight, A-coded</li> <li><b>Connection type head B:</b> Flying leads</li> <li><b>Signal type:</b> Sensor/actuator cable</li> <li><b>Cable:</b> 2 m, 8-wire, PUR, halogen-free</li> <li><b>Application:</b> Drag chain operation, Zones with oils and lubricants, Robot, Drag chain operation</li> </ul>	YF2A18-020UA5XLEAX	2095652
<b>Mounting systems</b>			
	<ul style="list-style-type: none"> <li><b>Description:</b> FlexFix bracket for 2 devices (e.g. sender and receiver), can be aligned <math>\pm 15^\circ</math>, including M5 screw</li> <li><b>Material:</b> Plastic</li> <li><b>Details:</b> Plastic</li> <li><b>Packing unit:</b> 4 pieces</li> </ul>	BEF-1SHABPKU4	2066614
	<ul style="list-style-type: none"> <li><b>Description:</b> QuickFix bracket for 2 devices (e.g. sender and receiver)</li> <li><b>Material:</b> Plastic</li> <li><b>Details:</b> Plastic</li> <li><b>Packing unit:</b> 4 pieces</li> </ul>	BEF-3SHABPKU4	2098710
	<ul style="list-style-type: none"> <li><b>Description:</b> Muting arm bracket for deTec safety light curtain or deTem safety multibeam sensor</li> <li><b>Packing unit:</b> 1 piece</li> <li><b>Suitable for:</b> deTec, deTem</li> </ul>	Muting arm bracket	2106455
	<ul style="list-style-type: none"> <li><b>Description:</b> Sensor bracket G6 and P250</li> </ul>	BEF-2KHAAKU1	2113145
	<ul style="list-style-type: none"> <li><b>Description:</b> Muting arm, short</li> <li><b>Suitable for:</b> deTec, deTem</li> </ul>	Muting arm, short	2111924
	<ul style="list-style-type: none"> <li><b>Description:</b> Muting arm, long</li> <li><b>Suitable for:</b> deTec, deTem</li> </ul>	Muting arm, long	2111923
	<ul style="list-style-type: none"> <li><b>Description:</b> Universal holder for round steel arms and muting arms, for mounting sensors or reflectors</li> </ul>	BEF-KHS-N01	2044953

	Brief description	Type	part no.
system plugs and extension modules			
	<ul style="list-style-type: none"> <li>• <b>Function range:</b> SP1</li> <li>• <b>System connection:</b> Plug, M12, 5-pin</li> <li>• <b>Extension connection:</b> Without extension connection</li> </ul>	SP1-1000	2076832
	<ul style="list-style-type: none"> <li>• <b>Function range:</b> SP1</li> <li>• <b>System connection:</b> Plug, M12, 5-pin</li> <li>• <b>Extension connection:</b> Female connector M12, 5-pin</li> </ul>	SP1-1100	2076833
	<ul style="list-style-type: none"> <li>• <b>Function range:</b> SP1</li> <li>• <b>System connection:</b> Male connector M12, 8-pin</li> <li>• <b>Extension connection:</b> Without extension connection</li> </ul>	SP1-1200	2076834
	<ul style="list-style-type: none"> <li>• <b>Function range:</b> SP1</li> <li>• <b>System connection:</b> Male connector M12, 8-pin</li> <li>• <b>Extension connection:</b> Female connector M12, 5-pin</li> </ul>	SP1-1300	2076835
	<ul style="list-style-type: none"> <li>• <b>Function range:</b> SP2</li> <li>• <b>System connection:</b> Plug, M12, 5-pin</li> <li>• <b>Extension connection:</b> Without extension connection</li> </ul>	SP2-2000	2093097
	<ul style="list-style-type: none"> <li>• <b>Function range:</b> SP2</li> <li>• <b>System connection:</b> Plug, M12, 5-pin</li> <li>• <b>Extension connection:</b> Female connector M12, 5-pin</li> </ul>	SP2-2100	2093098
	<ul style="list-style-type: none"> <li>• <b>Function range:</b> SP2</li> <li>• <b>System connection:</b> Male connector M12, 8-pin</li> <li>• <b>Extension connection:</b> Without extension connection</li> </ul>	SP2-2200	2093099
	<ul style="list-style-type: none"> <li>• <b>Function range:</b> SP2</li> <li>• <b>System connection:</b> Male connector M12, 8-pin</li> <li>• <b>Extension connection:</b> Female connector M12, 5-pin</li> </ul>	SP2-2300	2093100

	Brief description	Type	part no.
network devices			
		IOLA2US-01101 (SiLink2 Master)	1061790
		SIG200-0A0G12200	1102605
		SIG200-0A0412200	1089794
		SIG200-0A0512200	1089796

	Brief description	Type	part no.
Photoelectric sensors			
	<ul style="list-style-type: none"> <li>• <b>Sensing range max.:</b> 5 mm ... 500 mm</li> <li>• <b>Functional principle:</b> Photoelectric proximity sensor</li> <li>• <b>Connection type:</b> Cable with M12 male connector, 4-pin, 300 mm</li> <li>• <b>Type of light:</b> Infrared light</li> <li>• <b>Adjustment:</b> Potentiometer</li> <li>• <b>Housing:</b> Rectangular</li> </ul>	GTB6-P7441S56	1077541
	<ul style="list-style-type: none"> <li>• <b>Sensing range max.:</b> 0.15 m ... 12 m, 0.15 m ... 10 m</li> <li>• <b>Functional principle:</b> Photoelectric retro-reflective sensor</li> <li>• <b>Functional principle detail:</b> With minimum distance to reflector (dual lens system)</li> <li>• <b>Switching output:</b> PNP</li> <li>• <b>Switching mode:</b> Light/dark switching</li> <li>• <b>Connection type:</b> Male connector M12, 4-pin</li> <li>• <b>Light source:</b> PinPoint LED</li> <li>• <b>Adjustment:</b> None</li> </ul>	GL10-P4151	1069860
	<ul style="list-style-type: none"> <li>• <b>Sensing range max.:</b> 0.03 m ... 6 m</li> <li>• <b>Functional principle:</b> Photoelectric retro-reflective sensor</li> <li>• <b>Connection type:</b> Cable with M12 male connector, 4-pin</li> <li>• <b>Type of light:</b> Visible red light</li> <li>• <b>Adjustment:</b> Potentiometer</li> <li>• <b>Housing:</b> Rectangular</li> </ul>	GL6-P0211S49	1070568
	<ul style="list-style-type: none"> <li>• <b>Sensing range max.:</b> 20 mm ... 950 mm</li> <li>• <b>Functional principle:</b> Photoelectric proximity sensor</li> <li>• <b>Functional principle detail:</b> Background suppression</li> <li>• <b>Switching output:</b> PNP</li> <li>• <b>Switching mode:</b> Light switching</li> <li>• <b>Connection type:</b> Male connector M12, 4-pin</li> <li>• <b>Light source:</b> PinPoint LED</li> <li>• <b>Adjustment:</b> Potentiometer</li> </ul>	GTB10-P4411S01	1066852
reflectors and optics			
	<ul style="list-style-type: none"> <li>• <b>Description:</b> Rectangular, screw connection</li> <li>• <b>Dimensions:</b> 51 mm 61 mm</li> <li>• <b>Ambient operating temperature:</b> -30 °C ... +65 °C</li> </ul>	P250	5304812

## SICK AT A GLANCE

SICK is one of the leading manufacturers of intelligent sensors and sensor solutions for industrial applications. A unique range of products and services creates the perfect basis for controlling processes securely and efficiently, protecting individuals from accidents and preventing damage to the environment.

We have extensive experience in a wide range of industries and understand their processes and requirements. With intelligent sensors, we can deliver exactly what our customers need. In application centers in Europe, Asia and North America, system solutions are tested and optimized in accordance with customer specifications. All this makes us a reliable supplier and development partner.

Comprehensive services complete our offering: SICK LifeTime Services provide support throughout the machine life cycle and ensure safety and productivity.

For us, that is “Sensor Intelligence.”

## WORLDWIDE PRESENCE:

Contacts and other locations –[www.sick.com](http://www.sick.com)