



# GSE6L-F4211

G6

PHOTOELECTRIC SENSORS

**SICK**  
Sensor Intelligence.



### Ordering information

Type	part no.
GSE6L-F4211	1105830

Other models and accessories → [www.sick.com/G6](http://www.sick.com/G6)

Illustration may differ

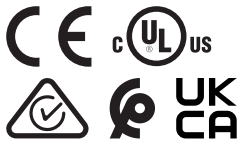

### Detailed technical data

#### Features

<b>Functional principle</b>	Through-beam photoelectric sensor
<b>Sensing range</b>	
Sensing range min.	0 m
Sensing range max.	40 m
Recommended sensing range for the best performance	0 m ... 30 m
<b>Polarisation filter</b>	No
<b>Emitted beam</b>	
Light source	Laser
Type of light	Visible red light
Shape of light spot	Point-shaped
Light spot size (distance)	Ø 3.5 mm (1,000 mm)
Maximum dispersion of the emitted beam around the standardized transmission axis (squint angle)	< +/- 1.5° (at T <sub>U</sub> = +23 °C)
<b>Key laser figures</b>	
Normative reference	IEC 60825-1 / CDRH 21 CFR 1040.10 & 1040.11
Laser class	1 <sup>1)</sup>
Wave length	680 nm
Pulse duration	3 µs
Maximum pulse power	≤ 7.8 mW
Average service life	100,000 h at T <sub>a</sub> = +25 °C
<b>Smallest detectable object (MDO) typ.</b>	3.5 mm, at 1 m distance (object with 90% remission factor (corresponds to standard white according to DIN 5033))
<b>Adjustment</b>	

<sup>1)</sup> Do not intentionally look into the laser beam. Never point the laser beam at people's eyes.

Potentiometer	For setting the sensing range
Operating mode switch	For inverting the switching function (light/dark switching)
<b>Display</b>	
LED green	Operating indicator Static on: power on
LED yellow	Status of received light beam Static on: object present Static off: object not present

<sup>1)</sup> Do not intentionally look into the laser beam. Never point the laser beam at people's eyes.

### Safety-related parameters

<b>MTTF<sub>D</sub></b>	1,005 years
<b>DC<sub>avg</sub></b>	0 %
<b>T<sub>M</sub> (mission time)</b>	10 years

### Electronics

<b>Supply voltage U<sub>B</sub></b>	10 V DC ... 30 V DC <sup>1)</sup>
<b>Ripple</b>	< 5 V <sub>pp</sub>
<b>Usage category</b>	DC-13 (According to EN 60947-5-2)
<b>Current consumption</b>	≤ 20 mA, without load. At U <sub>B</sub> = 24 V
<b>Protection class</b>	III
<b>Digital output</b>	
Number	2 (Complementary)
Type	PNP
Switching mode	Light/dark switching
Signal voltage NPN HIGH/LOW	Approx. U <sub>B</sub> / ≤ 3 V
Output current I <sub>max.</sub>	≤ 100 mA <sup>2)</sup>
Circuit protection outputs	Reverse polarity protected Overcurrent protected Short-circuit protected
Response time	≤ 625 μs
Switching frequency	1,000 Hz <sup>3)</sup>
<b>Pin/Wire assignment</b>	
Function of pin 4/black (BK)	Digital output, light switching, object present → output Q LOW
Function of pin 4/black (BK) – detail	The pin 4 function of the sensor can be switched Additional possible settings via operating mode switch
Function of pin 2/white (WH)	Digital output, dark switching, object present → output $\bar{Q}$ HIGH
Function of pin 2/white (WH) – detail	The pin 2 function of the sensor can be switched Additional possible settings via operating mode switch

<sup>1)</sup> Limit values.

<sup>2)</sup> At U<sub>B</sub> > 24 V, I max. = 50 mA.

<sup>3)</sup> With light/dark ratio 1:1.

### Mechanics

<b>Housing</b>	Rectangular
----------------	-------------

<b>Dimensions (W x H x D)</b>	12 mm x 31.5 mm x 21 mm
<b>Connection</b>	Male connector M8, 4-pin
<b>Material</b>	
Housing	Plastic, ABS
Front screen	Plastic, PMMA
Cable	Plastic, PVC
Male connector	Metal, copper alloy (C3604 CUZN39PB3)
<b>Weight</b>	Approx. 60 g

Ambient data

<b>Enclosure rating</b>	IP67 (EN 60529)
<b>Ambient operating temperature</b>	-20 °C ... +50 °C <sup>1) 2)</sup>
<b>Ambient temperature, storage</b>	-40 °C ... +70 °C
<b>Typ. Ambient light immunity</b>	Sunlight: ≤ 13,000 lx
<b>Shock resistance</b>	30 g, 11 ms (3 positive and 3 negative shocks along X, Y, Z axes, 18 total shocks (EN60068-2-27))
<b>Vibration resistance</b>	10 Hz ... 55 Hz (Amplitude 0.5 mm, 3 x 30 min (EN60068-2-6))
<b>Air humidity</b>	35 % ... 95 %, relative humidity (no condensation)
<b>Electromagnetic compatibility (EMC)</b>	EN 60947-5-2
<b>UL File No.</b>	NRKH.E348498 & NRKH7.E348498

<sup>1)</sup> As of T<sub>a</sub> => 45 °C, a max. supply voltage U<sub>B</sub> = 24 V and a max. load current I<sub>max.</sub> = 50 mA is permitted.

<sup>2)</sup> Below T<sub>u</sub> = -20 °C, a warm-up time of 3 seconds is required.

Certificates

<b>EU declaration of conformity</b>	✓
<b>UK declaration of conformity</b>	✓
<b>ACMA declaration of conformity</b>	✓
<b>Moroccan declaration of conformity</b>	✓
<b>China RoHS</b>	✓
<b>cULus certificate</b>	✓
<b>Laser safety (IEC 60825-1) declaration of manufacturer</b>	✓

Classifications

<b>ECLASS 5.0</b>	27270901
<b>ECLASS 5.1.4</b>	27270901
<b>ECLASS 6.0</b>	27270901
<b>ECLASS 6.2</b>	27270901
<b>ECLASS 7.0</b>	27270901
<b>ECLASS 8.0</b>	27270901
<b>ECLASS 8.1</b>	27270901
<b>ECLASS 9.0</b>	27270901
<b>ECLASS 10.0</b>	27270901
<b>ECLASS 11.0</b>	27270901

<b>ECLASS 12.0</b>	27270901
<b>ETIM 5.0</b>	EC002716
<b>ETIM 6.0</b>	EC002716
<b>ETIM 7.0</b>	EC002716
<b>ETIM 8.0</b>	EC002716
<b>UNSPSC 16.0901</b>	39121528

### Dimensional drawing

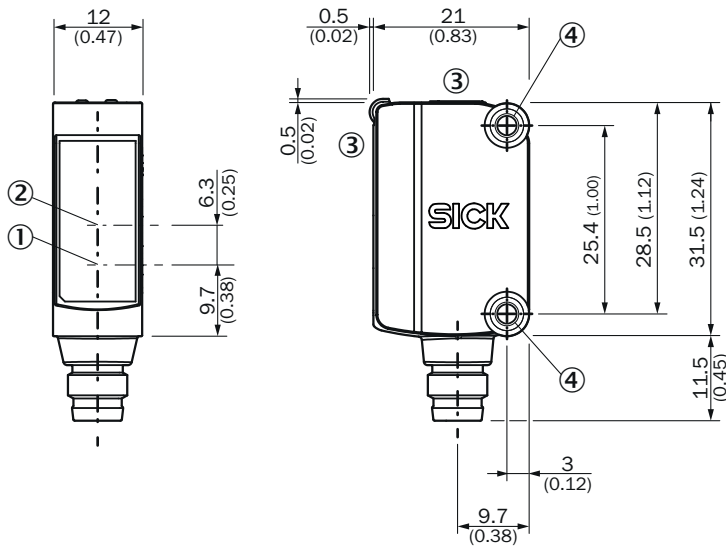

Dimensions in mm (inch)

- ① Center of optical axis, sender
- ② Center of optical axis, receiver
- ③ display and adjustment elements
- ④ Mounting holes M3

### display and adjustment elements

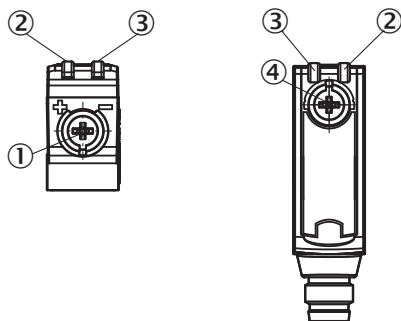

- ① Potentiometer
- ② LED yellow
- ③ LED green
- ④ operating mode switch

pinouts

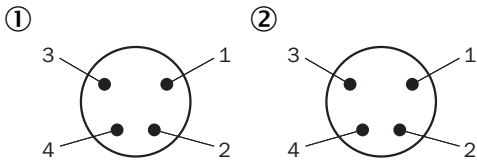

male connector M8, 4-pin

- ① receiver
- ② sender

Connection diagram Cd-232

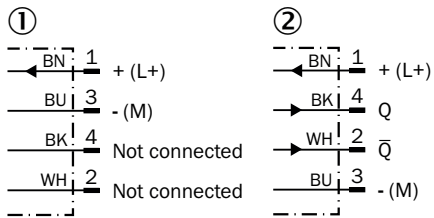

- ① sender
- ② receiver

Truth table PNP - light switching

	Light switching Q (normally closed)	
	Object not present → Output HIGH	Object present → Output LOW
Light receive	✔	✘
Light receive indicator	☀	✘
Load resistance	⚡	✘

Truth table PNP - dark switching

	Dark switching $\bar{Q}$ (normally open)	
	Object not present → Output LOW	Object present → Output HIGH
Light receive	✓	✗
Light receive indicator	☀	✗
Load resistance	✗	⚡

Characteristic curve

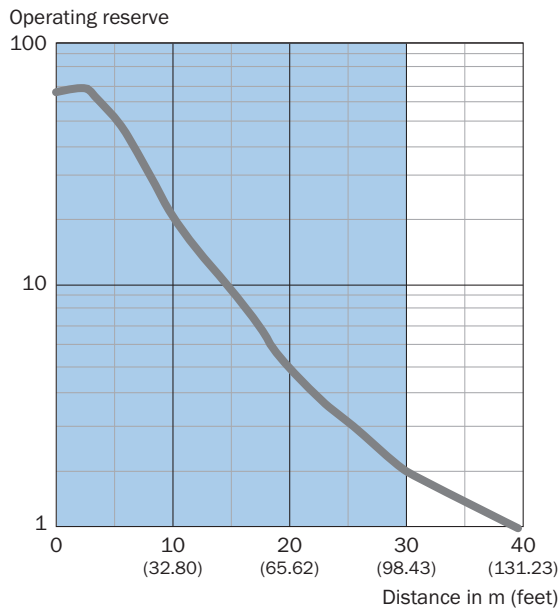

Recommended sensing range for the best performance

Light spot size

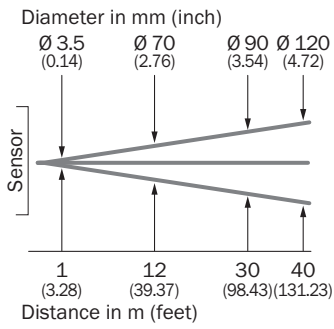

Sensing range diagram

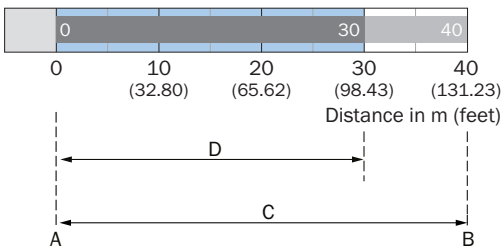







- A = Sensing range min. in m
- B = Sensing range max. in m
- C = Viewing range
- D = Adjustable switching threshold

Recommended sensing range for the best performance

## Recommended accessories

Other models and accessories → [www.sick.com/G6](http://www.sick.com/G6)

	Brief description	Type	part no.
<b>Mounting systems</b>			
	<ul style="list-style-type: none"> <li><b>Description:</b> Clamp bar to fix G6 sensors on rods of 12 mm, clamp-on design up to 4 mm wall thickness</li> <li><b>Material:</b> Steel</li> <li><b>Details:</b> Aluminum (clamp bar), stainless steel (bracket)</li> <li><b>Items supplied:</b> Clamp bar mounting and clamp function, mounting bracket, mounting hardware</li> </ul>	BEF-KHS-IS12G6	2086865
	<ul style="list-style-type: none"> <li><b>Description:</b> Mounting bracket for wall mounting</li> <li><b>Material:</b> Stainless steel</li> <li><b>Details:</b> Stainless steel</li> <li><b>Items supplied:</b> Mounting hardware included</li> <li><b>Suitable for:</b> W8, W8G, W8 Laser, W8 Inox, G6, G6 Inox, W100 Laser, W100-2, KTM Core, KTM Prime, CSM, LUTM, W4S</li> </ul>	BEF-W100-A	5311520
	<ul style="list-style-type: none"> <li><b>Material:</b> Stainless steel</li> <li><b>Details:</b> Stainless steel (1.4301)</li> <li><b>Suitable for:</b> W4S, W4S</li> </ul>	BEF-WN-G6	2062909
<b>connectors and cables</b>			
	<ul style="list-style-type: none"> <li><b>Description:</b> Unshielded</li> <li><b>Connection type head A:</b> Male connector, M8, 4-pin, straight, A-coded</li> <li><b>Connection systems:</b> Screw-type terminals</li> <li><b>Permitted cross-section:</b> 0.14 mm<sup>2</sup> ... 0.5 mm<sup>2</sup></li> </ul>	STE-0804-G	6037323
	<ul style="list-style-type: none"> <li><b>Description:</b> Sensor/actuator cable, unshielded</li> <li><b>Connection type head A:</b> Female connector, M8, 4-pin, straight, A-coded</li> <li><b>Connection type head B:</b> Flying leads</li> <li><b>Signal type:</b> Sensor/actuator cable</li> <li><b>Cable:</b> 5 m, 4-wire, PUR, halogen-free</li> <li><b>Application:</b> Drag chain operation, Zones with oils and lubricants, Robot, Drag chain operation</li> </ul>	YF8U14-050UA3XLEAX	2094792
	<ul style="list-style-type: none"> <li><b>Description:</b> Sensor/actuator cable, unshielded</li> <li><b>Connection type head A:</b> Female connector, M8, 4-pin, straight, A-coded</li> <li><b>Connection type head B:</b> Flying leads</li> <li><b>Signal type:</b> Sensor/actuator cable</li> <li><b>Cable:</b> 5 m, 4-wire, PVC</li> <li><b>Application:</b> Uncontaminated zones, Zones with chemicals</li> </ul>	YF8U14-050VA3XLEAX	2095889

## SICK AT A GLANCE

SICK is one of the leading manufacturers of intelligent sensors and sensor solutions for industrial applications. A unique range of products and services creates the perfect basis for controlling processes securely and efficiently, protecting individuals from accidents and preventing damage to the environment.

We have extensive experience in a wide range of industries and understand their processes and requirements. With intelligent sensors, we can deliver exactly what our customers need. In application centers in Europe, Asia and North America, system solutions are tested and optimized in accordance with customer specifications. All this makes us a reliable supplier and development partner.

Comprehensive services complete our offering: SICK LifeTime Services provide support throughout the machine life cycle and ensure safety and productivity.

For us, that is “Sensor Intelligence.”

## WORLDWIDE PRESENCE:

Contacts and other locations –[www.sick.com](http://www.sick.com)