



# NAV210-10100

NAV2xx

2D LIDAR SENSORS

**SICK**  
Sensor Intelligence.



### Ordering information

Type	part no.
NAV210-10100	1103318

Other models and accessories → [www.sick.com/NAV2xx](http://www.sick.com/NAV2xx)



### Detailed technical data

#### Features

<b>Application</b>	Indoor
<b>Light source</b>	Laser diode (905 nm)
<b>Laser class</b>	1 (IEC 60825-1:2014, EN 60825-1:2014+A11:2021)
<b>Aperture angle</b>	Horizontal 270°
<b>Scanning frequency</b>	≥ 25 Hz
<b>Angular resolution</b>	Horizontal 0.25°, on raw / contour data
<b>Working range</b>	0.5 m ... 50 m
<b>Scanning range</b>	At 10% remission factor 18 m
	At 90% remission factor 50 m

#### Mechanics/electronics

<b>Connection type</b>	2 x M12 male connector/female connector
<b>Supply voltage</b>	10.8 V DC ... 30 V DC
<b>Power consumption</b>	Typ. 8 W, heating typ. 35 W
<b>Housing material</b>	Aluminum die cast
<b>Housing color</b>	Light blue (RAL 5012)
<b>Enclosure rating</b>	IP65 (EN 60529/A1 (2002-02))
<b>Protection class</b>	III (EN 61140 (2002-03))
<b>Weight</b>	1.1 kg
<b>Dimensions (L x W x H)</b>	124.9 mm x 102 mm x 152 mm
<b>MTBF</b>	> 100 years
<b>MTTFd</b>	> 100 years

## Safety-related parameters

<b>MTF<sub>D</sub></b>	> 100 years
------------------------	-------------

## Performance

<b>Systematic error</b>	Typ. ± 30 mm (Contour)
<b>Statistical error</b>	Typ. 12 mm (Contour) <sup>1)</sup>
<b>Temperature drift</b>	Typ. 0.1 mm/K

<sup>1)</sup> 1 σ.

## Interfaces

<b>Ethernet</b>	Function	✓, TCP/IP
	Data transmission rate	10/100 MBit/s
<b>Serial</b>	Function	✓, RS-232
	Data transmission rate	9.6 kBaud ... 115.2 kBaud

## Ambient data

<b>Electromagnetic compatibility (EMC)</b>	EN 61000-6-2:2005-08 / EN 61000-6-4 (2007-01)
<b>Vibration resistance</b>	EN 60068-2-6 (1995-04)
<b>Ambient operating temperature</b>	-30 °C ... +50 °C
<b>Storage temperature</b>	-30 °C ... +70 °C
<b>Permissible relative humidity</b>	≤ 85 %, Non-condensing

## General notes

<b>Note on use</b>	The sensor does not constitute a safety component as defined by relevant legislation on machine safety.
--------------------	---

## Certificates

<b>EU declaration of conformity</b>	✓
<b>UK declaration of conformity</b>	✓
<b>ACMA declaration of conformity</b>	✓
<b>China RoHS</b>	✓
<b>cTUVus certificate</b>	✓
<b>Information according to Art. 3 of Data Act (Regulation EU 2023/2854)</b>	✓

## Classifications

<b>ECLASS 5.0</b>	27270990
<b>ECLASS 5.1.4</b>	27270990
<b>ECLASS 6.0</b>	27270913
<b>ECLASS 6.2</b>	27270913
<b>ECLASS 7.0</b>	27270913
<b>ECLASS 8.0</b>	27270913
<b>ECLASS 8.1</b>	27270913

<b>ECLASS 9.0</b>	27270913
<b>ECLASS 10.0</b>	27270913
<b>ECLASS 11.0</b>	27270913
<b>ECLASS 12.0</b>	27270913
<b>ETIM 5.0</b>	EC002550
<b>ETIM 6.0</b>	EC002550
<b>ETIM 7.0</b>	EC002550
<b>ETIM 8.0</b>	EC002550
<b>UNSPSC 16.0901</b>	41111615



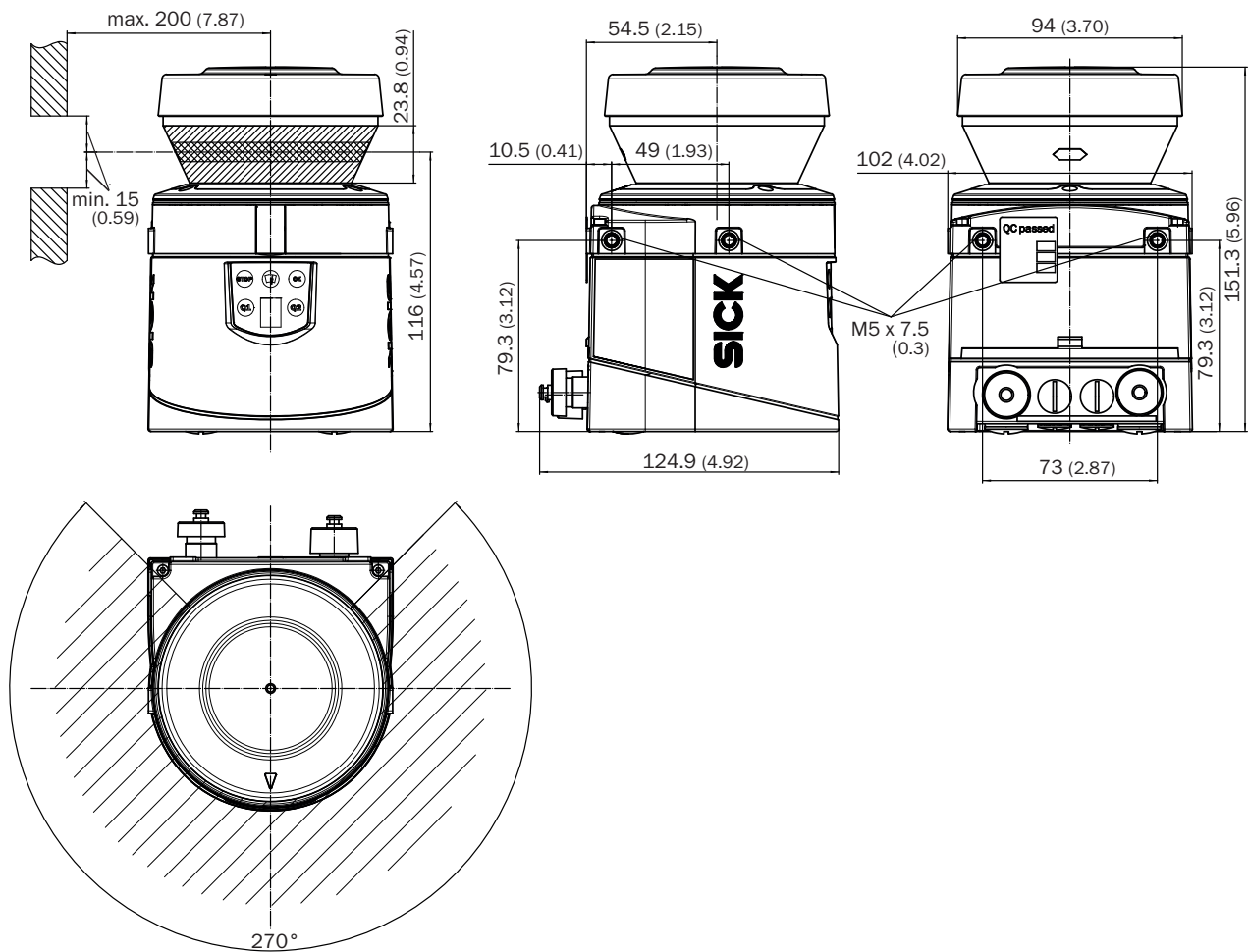



### Dimensional drawing



Dimensions in mm (inch)

## Recommended accessories

Other models and accessories → [www.sick.com/NAV2xx](http://www.sick.com/NAV2xx)

	Brief description	Type	part no.
connectors and cables			
	<ul style="list-style-type: none"> <li><b>Description:</b> Sensor/actuator cable, shielded</li> <li><b>Connection type head A:</b> Female connector, M12, 8-pin, straight, A-coded</li> <li><b>Connection type head B:</b> Flying leads</li> <li><b>Signal type:</b> Sensor/actuator cable</li> <li><b>Cable:</b> 5 m, 8-wire, PUR, halogen-free</li> <li><b>Application:</b> Drag chain operation, Zones with oils and lubricants, Robot, Drag chain operation</li> </ul>	YF2A28-050UA6XLEAX	2095835
	<ul style="list-style-type: none"> <li><b>Description:</b> Sensor/actuator cable, shielded</li> <li><b>Connection type head A:</b> Female connector, M12, 8-pin, straight, A-coded</li> <li><b>Connection type head B:</b> Flying leads</li> <li><b>Signal type:</b> Sensor/actuator cable</li> <li><b>Cable:</b> 0.6 m, 8-wire, PUR, halogen-free</li> <li><b>Application:</b> Drag chain operation, Zones with oils and lubricants, Robot, Drag chain operation</li> </ul>	YF2A28-C60UA6XLEAX	2145470
	<ul style="list-style-type: none"> <li><b>Description:</b> Sensor/actuator cable, shielded</li> <li><b>Connection type head A:</b> Female connector, M12, 8-pin, straight, A-coded</li> <li><b>Connection type head B:</b> Flying leads</li> <li><b>Signal type:</b> Sensor/actuator cable</li> <li><b>Cable:</b> 1 m, 8-wire, PUR, halogen-free</li> <li><b>Application:</b> Drag chain operation, Zones with oils and lubricants, Robot, Drag chain operation</li> </ul>	YF2A28-010UA6XLEAX	2145471
	<ul style="list-style-type: none"> <li><b>Description:</b> Sensor/actuator cable, shielded</li> <li><b>Connection type head A:</b> Female connector, M12, 8-pin, straight, A-coded</li> <li><b>Connection type head B:</b> Flying leads</li> <li><b>Signal type:</b> Sensor/actuator cable</li> <li><b>Cable:</b> 2 m, 8-wire, PUR, halogen-free</li> <li><b>Application:</b> Drag chain operation, Zones with oils and lubricants, Robot, Drag chain operation</li> </ul>	YF2A28-020UA6XLEAX	2145472
	<ul style="list-style-type: none"> <li><b>Description:</b> Sensor/actuator cable, shielded</li> <li><b>Connection type head A:</b> Female connector, M12, 8-pin, straight, A-coded</li> <li><b>Connection type head B:</b> Flying leads</li> <li><b>Signal type:</b> Sensor/actuator cable</li> <li><b>Cable:</b> 3 m, 8-wire, PUR, halogen-free</li> <li><b>Application:</b> Drag chain operation, Zones with oils and lubricants, Robot, Drag chain operation</li> </ul>	YF2A28-030UA6XLEAX	2145473
	<ul style="list-style-type: none"> <li><b>Connection type head A:</b> Male connector, M12, 4-pin, straight, D-coded</li> <li><b>Connection type head B:</b> Male connector, RJ45, 4-pin, straight</li> <li><b>Signal type:</b> Ethernet, PROFINET</li> <li><b>Cable:</b> 5 m, 4-wire, PUR, halogen-free</li> <li><b>Description:</b> Ethernet, shielded, PROFINET</li> <li><b>Application:</b> Drag chain operation, Zones with oils and lubricants</li> </ul>	YM2D24-050P-N1MRJA4	2106184
Mounting systems			
	<ul style="list-style-type: none"> <li><b>Description:</b> Mounting plate, adjustable longitudinal axis, only in conjunction with mounting kit 2 (2039302)</li> <li><b>Material:</b> Anodized aluminum</li> <li><b>Details:</b> AlMg3, black anodized</li> <li><b>Packing unit:</b> 1 piece</li> <li><b>Items supplied:</b> Mounting plate, 2 x countersunk screws with washers M4 x 10, 2 x spring washer</li> </ul>	Mounting kit 3	2039303
	<ul style="list-style-type: none"> <li><b>Description:</b> Mounting bracket for rear mounting on wall or machine with protection of optics hood</li> <li><b>Material:</b> Anodized aluminum</li> <li><b>Details:</b> AlMg3, black anodized</li> <li><b>Packing unit:</b> 1 piece</li> <li><b>Items supplied:</b> Mounting bracket, 4 x M5 x 10 countersunk screws</li> </ul>	Mounting kit 1b	2034325
	<ul style="list-style-type: none"> <li><b>Description:</b> Mounting bracket, adjustable lateral axis, only in conjunction with mounting kit 1a (2034324) or 1b (2034325)</li> <li><b>Material:</b> Anodized aluminum</li> <li><b>Details:</b> AlMg3, black anodized</li> <li><b>Packing unit:</b> 1 piece</li> <li><b>Items supplied:</b> Mounting bracket, 4 x countersunk screws with washers M4 x 10, 4 x spring washer</li> </ul>	Mounting kit 2	2039302
	<ul style="list-style-type: none"> <li><b>Description:</b> Mounting bracket for rear mounting on wall or machine</li> <li><b>Material:</b> Anodized aluminum</li> <li><b>Details:</b> AlMg3, black anodized</li> <li><b>Packing unit:</b> 1 piece</li> <li><b>Items supplied:</b> Mounting bracket, 4 x M5 x 10 countersunk screws</li> </ul>	Mounting kit 1a	2034324

## SICK AT A GLANCE

SICK is one of the leading manufacturers of intelligent sensors and sensor solutions for industrial applications. A unique range of products and services creates the perfect basis for controlling processes securely and efficiently, protecting individuals from accidents and preventing damage to the environment.

We have extensive experience in a wide range of industries and understand their processes and requirements. With intelligent sensors, we can deliver exactly what our customers need. In application centers in Europe, Asia and North America, system solutions are tested and optimized in accordance with customer specifications. All this makes us a reliable supplier and development partner.

Comprehensive services complete our offering: SICK LifeTime Services provide support throughout the machine life cycle and ensure safety and productivity.

For us, that is “Sensor Intelligence.”

## WORLDWIDE PRESENCE:

Contacts and other locations –[www.sick.com](http://www.sick.com)