



IHM03-0B6PSVU2S

IMM

INDUCTIVE PROXIMITY SENSORS

SICK
Sensor Intelligence.



Ordering information

Type	part no.
IHM03-OB6PSVU2S	1102476

Other models and accessories → www.sick.com/IMM

Illustration may differ



Detailed technical data

Features

Housing	Cylindrical
Housing	Standard design
Diameter	Ø 3 mm
Sensing range S_n	0.6 mm
Safe sensing range S_a	0.486 mm
Installation type	Flush
Switching frequency	5,000 Hz
Connection type	Cable, 3-wire, 2 m
Switching output	PNP
Switching output detail	PNP
Output function	NO
Electrical wiring	DC 3-wire
Enclosure rating	IP67 ¹⁾
Special features	Visual adjustment indicator
Items supplied	Cable flag, Polymatic 50 (1 x)

¹⁾ According to EN 60529.

Mechanics/electronics

Supply voltage	10 V DC ... 30 V DC
Ripple	≤ 20 % ¹⁾

¹⁾ Of V_S .

²⁾ With $I_a = 200$ mA.

³⁾ Supply voltage U_B and constant ambient temperature T_a .

Voltage drop	$\leq 2 \text{ V}^{2)}$
Time delay before availability	$\leq 10 \text{ ms}$
Hysteresis	1 % ... 15 %
Reproducibility	$\leq 2.5 \text{ \%}^{3)}$
Temperature drift (of S_r)	$\leq 10 \text{ \%}$
EMC	EN 60947-5-2
Continuous current I_a	$\leq 100 \text{ mA}$
Cable material	PUR
Conductor size	0.08 mm ²
Cable diameter	Ø 2.5 mm
Short-circuit protection	✓
Power-up pulse protection	✓
Shock and vibration resistance	30 g, 11 ms / 10 ... 55 Hz, 1 mm
Ambient operating temperature	-25 °C ... +70 °C
Housing material	Stainless steel V2A, DIN 1.4305 / AISI 303
Sensing face material	Plastic, LCP
Housing length	22 mm
UL File No.	NRKH.E348498

1) Of V_S .

2) With $I_a = 200 \text{ mA}$.

3) Supply voltage U_B and constant ambient temperature T_a .

Safety-related parameters

MTTF_D	1,638 years
DC_{avg}	0 %

Communication interface

Communication interface	IO-Link V1.1
Communication Interface detail	COM2 (38,4 kBaud)
Cycle time	10.4 ms
Process data length	1 Byte
Process data structure	Bit 0 = S_r reached Bit 1 = S_a reached

Reduction factors

Note	The values are reference values which may vary
St37 steel (Fe)	1
Stainless steel (V2A, 304)	Approx. 0.75
Aluminum (Al)	Approx. 0.54
Copper (Cu)	Approx. 0.39
Brass (Br)	Approx. 0.63

Installation note

Remark	Associated graphic see "Installation"
B	2.5 mm

C	3 mm
D	1.8 mm
F	5 mm

Certificates

EU declaration of conformity	✓
UK declaration of conformity	✓
ACMA declaration of conformity	✓
Moroccan declaration of conformity	✓
China RoHS	✓
cULus certificate	✓
IO-Link certificate	✓

Classifications

ECLASS 5.0	27270101
ECLASS 5.1.4	27270101
ECLASS 6.0	27270101
ECLASS 6.2	27270101
ECLASS 7.0	27270101
ECLASS 8.0	27270101
ECLASS 8.1	27270101
ECLASS 9.0	27270101
ECLASS 10.0	27270101
ECLASS 11.0	27270101
ECLASS 12.0	27274001
ETIM 5.0	EC002714
ETIM 6.0	EC002714
ETIM 7.0	EC002714
ETIM 8.0	EC002714
UNSPSC 16.0901	39122230

Installation note Mounting using BEF-KH-M03 bracket

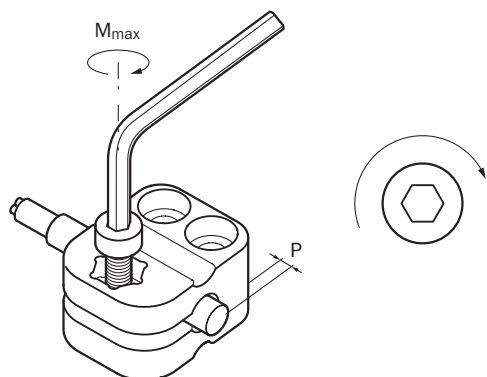

Sensor type	Mounting adapter	Overrun (P)	Max. tightening torque (M_{max})
IHM03-0B6***** IHM03-01B*****	BEF-KH-M03, part no. 2101064	0 mm ... 2 mm / ≥ 2 mm	≤ 0.4 Nm / ≤ 0.6 Nm

Installation note Fixing with setscrew

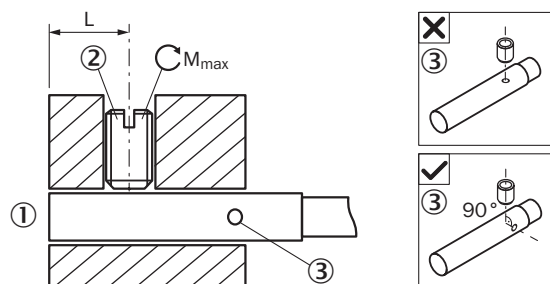

- ① Sensing face
- ② Recommended setscrew: M3, flat point
- ③ Display LED

Sensor type	Mounting area (L)	Max. tightening torque (M_{max})
IHM03-01B*****K	5.5 mm ... 9 mm	≤ 0.2 Nm
IHM03-0B6*****S IHM03-01B*****S	5.5 mm ... 19 mm	≤ 0.2 Nm

Installation note Flush installation

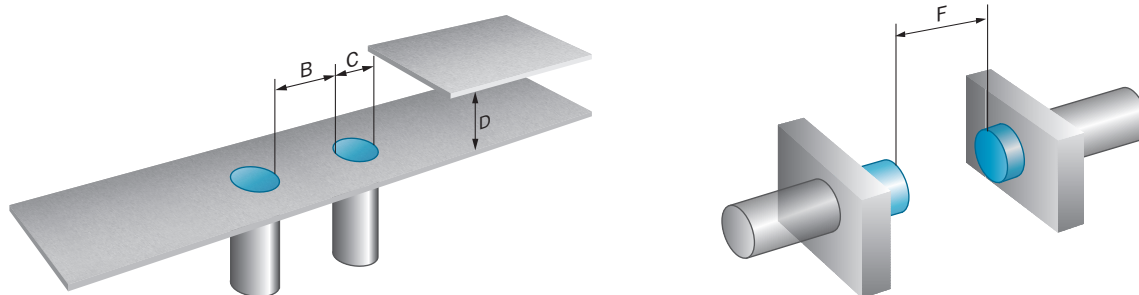

Connection diagram Cd-001

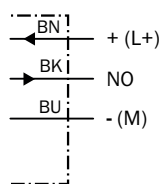

Response diagram

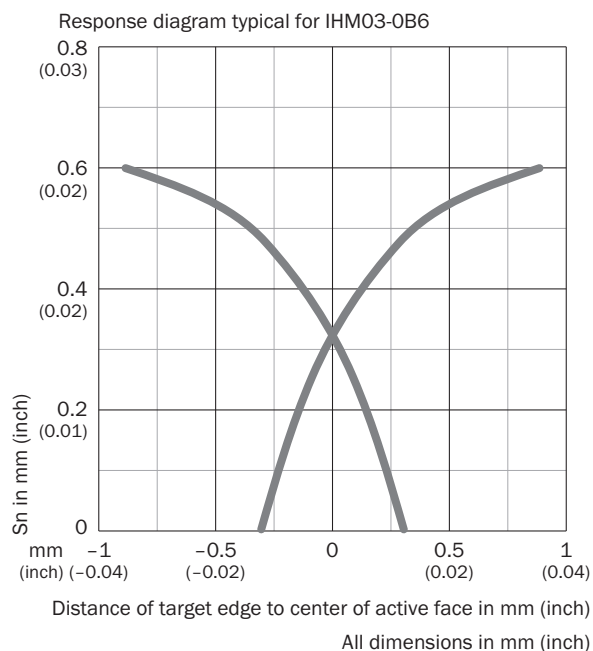

Functional principle Installation aid

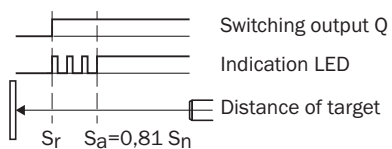



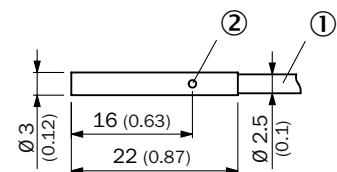

Dimensional drawing IHM03, standard variant, flush, cable



- ① Connection
- ② function indicator

Recommended accessories

Other models and accessories → www.sick.com/IMM

	Brief description	Type	part no.
Mounting systems			
	<ul style="list-style-type: none"> Material: Plastic Details: Plastic (PA6) Items supplied: Without mounting hardware Usable for: Round sensors with 3 mm housing diameter without fixed stop 	BEF-KH-M03	2101064
connectors and cables			
	<ul style="list-style-type: none"> Number of slots: 4 Slot connection type: M8, 3-pin, A-coded, female connector Items supplied: 5 x labeling plates Description: Unshielded 	Y8A34A2-C2A8000XXX	2115733
	<ul style="list-style-type: none"> Number of slots: 4 Slot connection type: M8, 3-pin, A-coded, female connector Items supplied: 5 x labeling plates Cable: 5 m, 6-wire, PUR, halogen-free Description: Unshielded Application: Drag chain operation 	Y8A34A2-LXXXUAA050	2115727
	<ul style="list-style-type: none"> Number of slots: 6 Slot connection type: M8, 3-pin, A-coded, female connector Items supplied: 5 x labeling plates Description: Unshielded 	Y8A36A2-C2A8000XXX	2115734
	<ul style="list-style-type: none"> Number of slots: 6 Slot connection type: M8, 3-pin, A-coded, female connector Items supplied: 5 x labeling plates Cable: 5 m, 8-wire, PUR, halogen-free Description: Unshielded Application: Drag chain operation 	Y8A36A2-LXXXUBA050	2115728

SICK AT A GLANCE

SICK is one of the leading manufacturers of intelligent sensors and sensor solutions for industrial applications. A unique range of products and services creates the perfect basis for controlling processes securely and efficiently, protecting individuals from accidents and preventing damage to the environment.

We have extensive experience in a wide range of industries and understand their processes and requirements. With intelligent sensors, we can deliver exactly what our customers need. In application centers in Europe, Asia and North America, system solutions are tested and optimized in accordance with customer specifications. All this makes us a reliable supplier and development partner.

Comprehensive services complete our offering: SICK LifeTime Services provide support throughout the machine life cycle and ensure safety and productivity.

For us, that is “Sensor Intelligence.”

WORLDWIDE PRESENCE:

Contacts and other locations –www.sick.com