



HL18B-M1G3AA

H18 Sure Sense

PHOTOELECTRIC SENSORS

SICK
Sensor Intelligence.



Illustration may differ



Ordering information

Type	part no.
HL18B-M1G3AA	1101633

Other models and accessories → www.sick.com/H18_Sure_Sense

Detailed technical data

Features

Functional principle	Photoelectric retro-reflective sensor	
Functional principle detail	With minimum distance to reflector (dual lens system)	
Dimensions (W x H x D)	16.2 mm x 50.1 mm x 34.4 mm	
Housing design (light emission)	Hybrid	
Thread diameter (housing)	M18	
Mounting system type	M18, head/M18, base/side (24.1 ... 25.4 mm)	
Housing color	Blue	
Sensing range max.	0.03 m ... 6.5 m ¹⁾	
Sensing range	0.03 m ... 5 m ¹⁾	
Type of light	Visible red light	
Light source	PinPoint LED ²⁾	
Light spot size (distance)	130 mm x 260 mm (6.5 m)	
Wave length	631 nm	
Adjustment		
	Potentiometer, right	None
	Potentiometer, left	None
Special features	-	

¹⁾ Reflector PL80A.

²⁾ Average service life: 100,000 h at T_U = +25 °C.

Mechanics/electronics

Supply voltage	21.6 V DC ... 250 V DC, 96 V AC ... 250 V AC ¹⁾
Current consumption	≤ 10 mA ²⁾
Switching output	MOSFET
Switching mode	Dark switching
Switching output detail	
Switching output Q1	MOSFET, Dark switching
Output current I_{max.}	≤ 100 mA
Response time	≤ 0.5 ms ³⁾
Switching frequency	1,000 Hz ⁴⁾
Connection type	Cable open end, 2,000 mm
Cable material	Plastic, PVC
Conductor cross section	0.2 mm ²
Circuit protection	A ⁵⁾ B ⁶⁾ D ⁷⁾
Protection class	II ⁸⁾
Weight	18 g
Polarizing filter	✓
Housing material	Plastic, VISTAL®
Optics material	Plastic, PMMA
Enclosure rating	IP67 IP69K
Items supplied	Fastening nut (1x), M18, plastic, black, flat
Electromagnetic compatibility (EMC)	EN 60947-5-2 (The sensor complies with the Radio Safety Requirements (EMC) for the industrial sector (Radio Safety Class A). It may cause radio interference if used in a residential area.)
Ambient operating temperature	-40 °C ... +70 °C
Ambient temperature, storage	-40 °C ... +75 °C
UL File No.	E189383

¹⁾ From T_u 60 °C, max. supply voltage = 120 V.

²⁾ Without load. The output load and sensor must use the same power source.

³⁾ Signal transit time with resistive load.

⁴⁾ With light/dark ratio 1:1.

⁵⁾ A = V_S connections reverse-polarity protected.

⁶⁾ B = inputs and output reverse-polarity protected.

⁷⁾ D = outputs overcurrent and short-circuit protected.

⁸⁾ Reference voltage: 250 V AC, overvoltage category 2.

Connection type/pinouts

Connection type	Cable open end, 2,000 mm
Connection type Detail	
Cable material	Plastic
Conductor cross section	0.2 mm ²
Pinouts	

	BN	L1
	BU	N
	BK	Q

Certificates

EU declaration of conformity	✓
UK declaration of conformity	✓
ACMA declaration of conformity	✓
Moroccan declaration of conformity	✓
China RoHS	✓

Classifications

ECLASS 5.0	27270902
ECLASS 5.1.4	27270902
ECLASS 6.0	27270902
ECLASS 6.2	27270902
ECLASS 7.0	27270902
ECLASS 8.0	27270902
ECLASS 8.1	27270902
ECLASS 9.0	27270902
ECLASS 10.0	27270902
ECLASS 11.0	27270902
ECLASS 12.0	27270902
ETIM 5.0	EC002717
ETIM 6.0	EC002717
ETIM 7.0	EC002717
ETIM 8.0	EC002717
UNSPSC 16.0901	39121528

Dimensional drawing

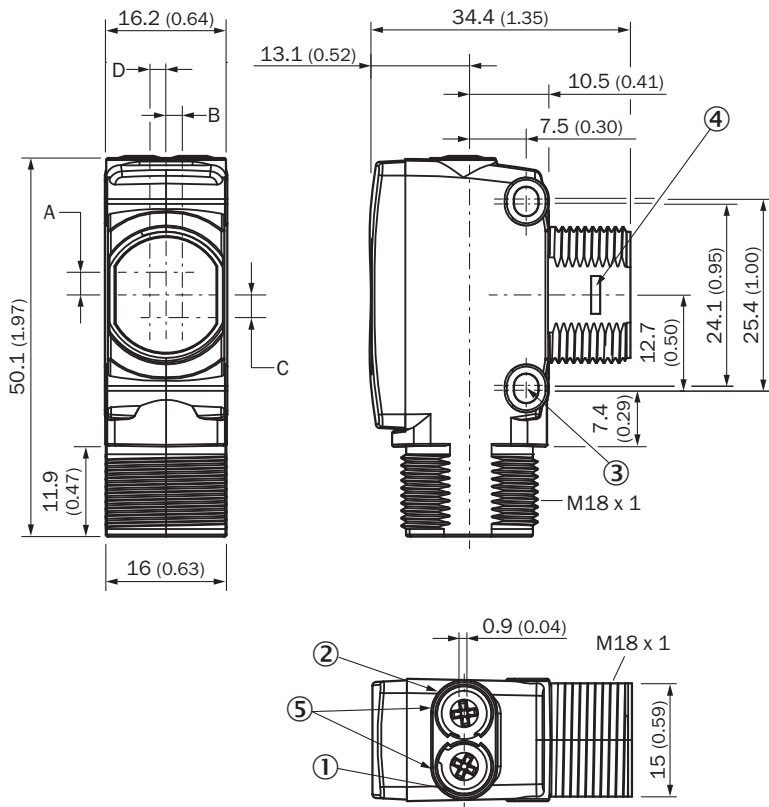

Dimensions in mm (inch)

- ① LED indicator yellow: Status of received light beam
- ② LED indicator green: power on
- ③ M3 mounting hole
- ④ Snap Connection for flush ring (sold separately)
- ⑤ Potentiometer (if selected) or LED Indicators

Dimensions in mm (inch)	Receiver		Sender	
	A	B	C	D
HTB18 / HTF18	- 1.1 (0.04)	1.1 (0.04)	4.7 (0.19)	0.6 (0.02)
HTE18 / HL18 / HSE18	2.5 (0.1)	0.0 (0.0)	4.0 (0.16)	0.0 (0.0)

Pinouts, see table Technical data: Connection type/pinouts

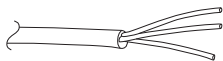

Cable, 3-wire

Characteristic curve

Operating reserve



- ① Reflector PL80A
- ② Reflector PL40A
- ⑥ Reflective tape IREF6000 (REF-IRF-56)

Light spot size

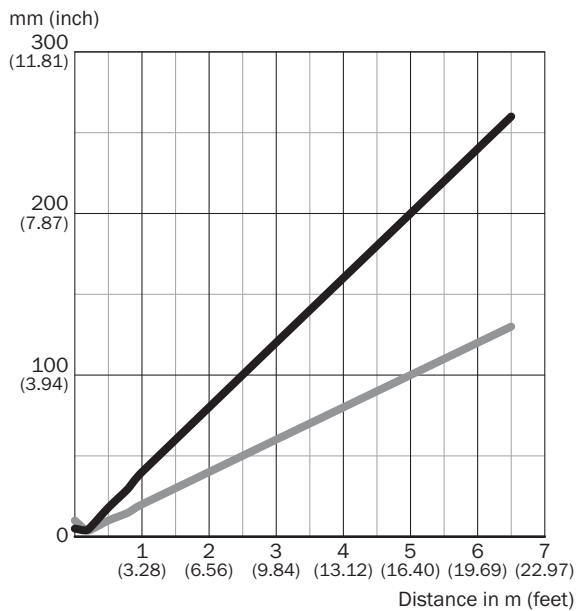

Dimensions in mm (inch)

Sensing range	Horizontal	Vertical
0.5 m (1.64 feet)	18 (0.71)	10 (0.39)
1 m (3.28 feet)	40 (1.57)	20 (0.79)
5 m (16.40 feet)	200 (7.87)	100 (3.94)
6.5 m (21.33 feet)	260 (10.24)	130 (5.12)

— Horizontal
— Vertical

Sensing range diagram

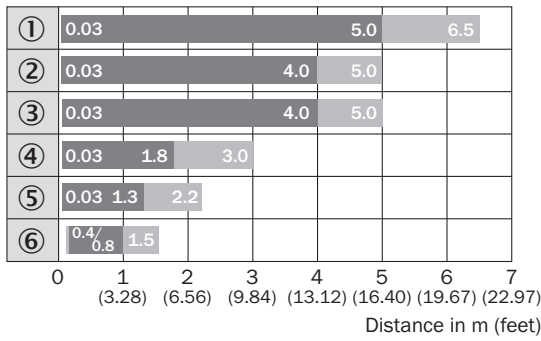

■ Sensing range ■ Sensing range max.



- ① Reflector PL80A
- ② Reflector PL40A
- ③ Reflector P250
- ④ Reflector PL30A, PL31A
- ⑤ Reflector PL20A
- ⑥ Reflective tape IREF6000 (REF-IRF-56)

Functions



Recommended accessories

Other models and accessories → www.sick.com/H18_Sure_Sense

	Brief description	Type	part no.
Mounting systems			
	<ul style="list-style-type: none"> • Description: Mounting bracket for M18 sensors • Material: Steel • Details: Steel, zinc coated • Items supplied: Without mounting hardware • Suitable for: GR18, V180-2, V18, W15, Z1, Z2 	BEF-WN-M18	5308446
	<ul style="list-style-type: none"> • Description: Universal mounting bracket for reflectors • Dimensions (W x H x L): 85 mm x 90 mm x 35 mm • Material: Steel • Details: Steel, zinc coated • Suitable for: C110A, P250, PL20, PL30A, PL40A, PL80A 	BEF-WN-REFX	2064574

	Brief description	Type	part no.
reflectors and optics			
	<ul style="list-style-type: none">• Description: Rectangular, screw connection• Dimensions: 51 mm 61 mm• Ambient operating temperature: -30 °C ... +65 °C	P250	5304812

SICK AT A GLANCE

SICK is one of the leading manufacturers of intelligent sensors and sensor solutions for industrial applications. A unique range of products and services creates the perfect basis for controlling processes securely and efficiently, protecting individuals from accidents and preventing damage to the environment.

We have extensive experience in a wide range of industries and understand their processes and requirements. With intelligent sensors, we can deliver exactly what our customers need. In application centers in Europe, Asia and North America, system solutions are tested and optimized in accordance with customer specifications. All this makes us a reliable supplier and development partner.

Comprehensive services complete our offering: SICK LifeTime Services provide support throughout the machine life cycle and ensure safety and productivity.

For us, that is “Sensor Intelligence.”

WORLDWIDE PRESENCE:

Contacts and other locations –www.sick.com