



GL6G-N0611S88

G6

PHOTOELECTRIC SENSORS

SICK
Sensor Intelligence.



Illustration may differ



Ordering information

Type	part no.
GL6G-N0611S88	1098975

Other models and accessories → www.sick.com/G6

Detailed technical data

Features

Functional principle	Photoelectric retro-reflective sensor
Functional principle detail	With minimum distance to reflector (dual lens system)
Sensing range max.	0.03 m ... 6 m ¹⁾
Sensing range	0.07 m ... 5 m ¹⁾
Polarisation filter	Yes
Emitted beam	
Light source	LED ²⁾
Type of light	Visible red light
Light spot size (distance)	Ø 15 mm (350 mm)
Key LED figures	
Wave length	650 nm
Adjustment	Potentiometer, 270° (Sensitivity)

¹⁾ Reflector PL80A.

²⁾ Average service life: 100,000 h at T_U = +25 °C.

Electronics

Supply voltage U_B	10 V DC ... 30 V DC ¹⁾
-------------------------------------	-----------------------------------

¹⁾ Limit values when operated in short-circuit protected network: max. 8 A.

²⁾ May not fall below or exceed U_V tolerances.

³⁾ Without load.

⁴⁾ At U_V > 24 V, I_A max. = 50 mA.

⁵⁾ Signal transit time with resistive load.

⁶⁾ With light/dark ratio 1:1.

⁷⁾ A = V_S connections reverse-polarity protected.

⁸⁾ B = inputs and output reverse-polarity protected.

⁹⁾ D = outputs overcurrent and short-circuit protected.

Ripple	$\pm 10\%$ ²⁾
Current consumption	30 mA ³⁾
Protection class	III
Digital output	
Type	NPN
Switching mode	Light switching
Signal voltage PNP HIGH/LOW	$V_S - (\leq 3\text{ V}) / \text{approx. } 0\text{ V}$
Output current I_{max}	$\leq 100\text{ mA}$ ⁴⁾
Response time	$< 625\ \mu\text{s}$ ⁵⁾
Switching frequency	1,000 Hz ⁶⁾
Circuit protection	A ⁷⁾ B ⁸⁾ D ⁹⁾

¹⁾ Limit values when operated in short-circuit protected network: max. 8 A.

²⁾ May not fall below or exceed U_V tolerances.

³⁾ Without load.

⁴⁾ At $U_V > 24\text{ V}$, $I_A \text{ max.} = 50\text{ mA}$.

⁵⁾ Signal transit time with resistive load.

⁶⁾ With light/dark ratio 1:1.

⁷⁾ A = V_S connections reverse-polarity protected.

⁸⁾ B = inputs and output reverse-polarity protected.

⁹⁾ D = outputs overcurrent and short-circuit protected.

Mechanics

Housing	Rectangular
Dimensions (W x H x D)	12 mm x 31.5 mm x 21 mm
Connection	Cable with M8 male connector, 4-pin ¹⁾
Connection detail	
Conductor size	0.14 mm ²
Length of cable (L)	200 mm ¹⁾
Material	
Housing	Plastic, ABS/PC
Front screen	Plastic, PMMA
Cable	Plastic, PVC
Weight	60 g

¹⁾ Do not bend below 0 °C.

Ambient data

Enclosure rating	IP67
Ambient operating temperature	-25 °C ... +55 °C ¹⁾
Ambient temperature, storage	-40 °C ... +70 °C

¹⁾ Temperature stability following adjustment +/-10 °C.

Certificates

EU declaration of conformity	✓
-------------------------------------	---

UK declaration of conformity	✓
ACMA declaration of conformity	✓
Moroccan declaration of conformity	✓
China RoHS	✓
cULus certificate	✓
Photobiological safety (DIN EN 62471) certificate	✓

Classifications

ECLASS 5.0	27270902
ECLASS 5.1.4	27270902
ECLASS 6.0	27270902
ECLASS 6.2	27270902
ECLASS 7.0	27270902
ECLASS 8.0	27270902
ECLASS 8.1	27270902
ECLASS 9.0	27270902
ECLASS 10.0	27270902
ECLASS 11.0	27270902
ECLASS 12.0	27270902
ETIM 5.0	EC002717
ETIM 6.0	EC002717
ETIM 7.0	EC002717
ETIM 8.0	EC002717
UNSPSC 16.0901	39121528

Dimensional drawing

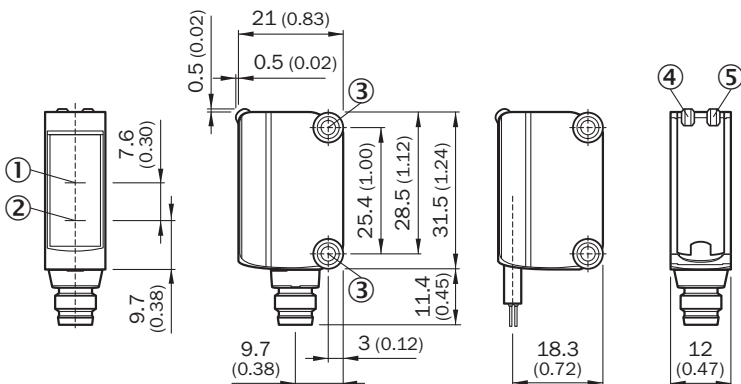

Dimensions in mm (inch)

- ① Optical axis, receiver
- ② Optical axis, sender
- ③ Mounting holes M3
- ④ LED indicator green: Supply voltage active
- ⑤ LED indicator yellow: Status of received light beam

Adjustments Adjustment possibility



- ④ LED indicator green: Supply voltage active
- ⑤ LED indicator yellow: Status of received light beam
- ⑦ Sensitivity control: potentiometer

Connection type

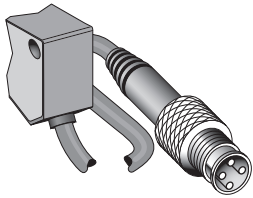

Connection diagram Cd-066

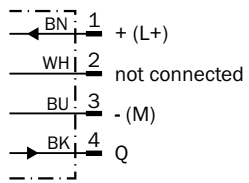

Characteristic curve

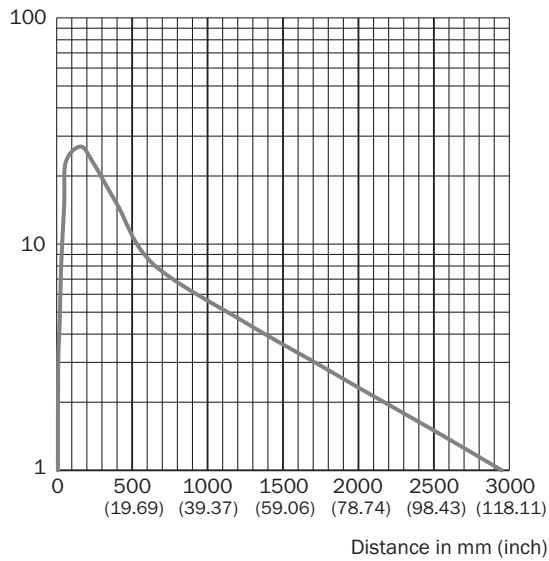

Characteristic curve typ. max. on reflector PL20A
 (measured in preferred direction)

Characteristic curve GL6

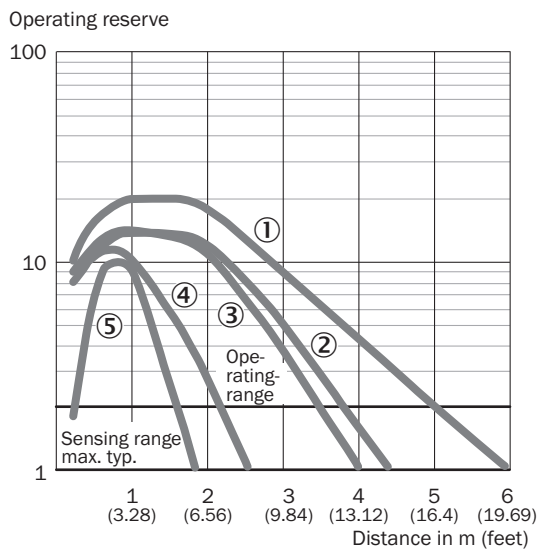

- ① Reflector PL80A
- ② Reflector PL40A
- ③ Reflector P250
- ④ Reflector PL20A
- ⑤ Reflective tape REF-IRF-56

Light spot size

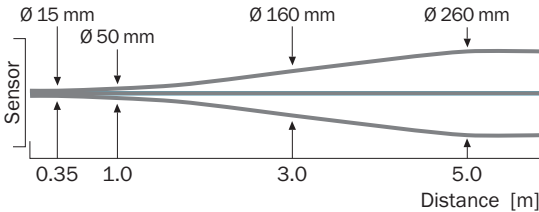

Light spot size GL6, GL6G

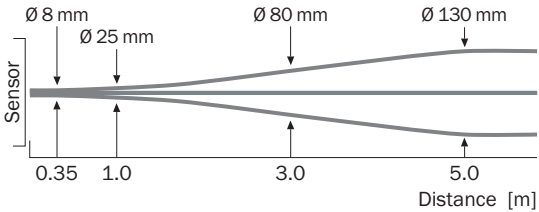

Sensing range diagram GL6, GL6G

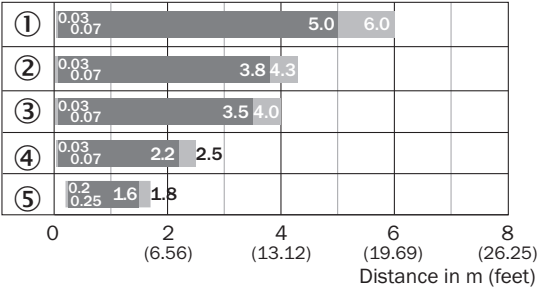

- Sensing range ■ Sensing range max.
- ① Reflector PL80A
- ② Reflector PL40A
- ③ Reflector P250
- ④ Reflector PL20A
- ⑤ Reflective tape REF-IRF-56

Recommended accessories

Other models and accessories → www.sick.com/G6

	Brief description	Type	part no.
Mounting systems			
	<ul style="list-style-type: none"> Description: Clamp bar to fix G6 sensors on rods of 12 mm, clamp-on design up to 4 mm wall thickness Material: Steel Details: Aluminum (clamp bar), stainless steel (bracket) Items supplied: Clamp bar mounting and clamp function, mounting bracket, mounting hardware 	BEF-KHS-IS12G6	2086865
	<ul style="list-style-type: none"> Material: Stainless steel Details: Stainless steel (1.4301) Suitable for: W4S, W4S 	BEF-WN-G6	2062909
	<ul style="list-style-type: none"> Description: Mounting bracket for wall mounting Material: Stainless steel Details: Stainless steel Items supplied: Mounting hardware included Suitable for: W8, W8G, W8 Laser, W8 Inox, G6, G6 Inox, W100 Laser, W100-2, KTM Core, KTM Prime, CSM, LUTM, W4S 	BEF-W100-A	5311520
	<ul style="list-style-type: none"> Description: Universal mounting bracket for reflectors Dimensions (W x H x L): 85 mm x 90 mm x 35 mm Material: Steel Details: Steel, zinc coated Suitable for: C110A, P250, PL20, PL30A, PL40A, PL80A 	BEF-WN-REFX	2064574
reflectors and optics			
	<ul style="list-style-type: none"> Description: Rectangular, screw connection Dimensions: 51 mm 61 mm Ambient operating temperature: -30 °C ... +65 °C 	P250	5304812
connectors and cables			
	<ul style="list-style-type: none"> Description: Sensor/actuator cable, unshielded Connection type head A: Female connector, M8, 4-pin, straight, A-coded Connection type head B: Flying leads Signal type: Sensor/actuator cable Cable: 5 m, 4-wire, PUR, halogen-free Application: Drag chain operation, Zones with oils and lubricants, Robot, Drag chain operation 	YF8U14-050UA3XLEAX	2094792
	<ul style="list-style-type: none"> Description: Sensor/actuator cable, unshielded Connection type head A: Female connector, M8, 4-pin, straight, A-coded Connection type head B: Flying leads Signal type: Sensor/actuator cable Cable: 5 m, 4-wire, PVC Application: Uncontaminated zones, Zones with chemicals 	YF8U14-050VA3XLEAX	2095889
	<ul style="list-style-type: none"> Description: Unshielded Connection type head A: Male connector, M8, 4-pin, straight, A-coded Connection systems: Screw-type terminals Permitted cross-section: 0.14 mm² ... 0.5 mm² 	STE-0804-G	6037323

SICK AT A GLANCE

SICK is one of the leading manufacturers of intelligent sensors and sensor solutions for industrial applications. A unique range of products and services creates the perfect basis for controlling processes securely and efficiently, protecting individuals from accidents and preventing damage to the environment.

We have extensive experience in a wide range of industries and understand their processes and requirements. With intelligent sensors, we can deliver exactly what our customers need. In application centers in Europe, Asia and North America, system solutions are tested and optimized in accordance with customer specifications. All this makes us a reliable supplier and development partner.

Comprehensive services complete our offering: SICK LifeTime Services provide support throughout the machine life cycle and ensure safety and productivity.

For us, that is “Sensor Intelligence.”

WORLDWIDE PRESENCE:

Contacts and other locations –www.sick.com