



DFS60I-BJNC01024

DFS60

INCREMENTAL ENCODERS

SICK
Sensor Intelligence.



Ordering information

Type	part no.
DFS60I-BJNC01024	1098157

Other models and accessories → www.sick.com/DFS60

Illustration may differ

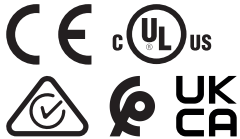

Detailed technical data

Safety-related parameters

MTTF_D (mean time to dangerous failure)	300 years (EN ISO 13849-1) ¹⁾
----------------------------------------------------------	------------------------------------------

¹⁾ This product is a standard product and does not constitute a safety component as defined in the Machinery Directive. Calculation based on nominal load of components, average ambient temperature 40 °C, frequency of use 8760 h/a. All electronic failures are considered hazardous. For more information, see document no. 8015532.

Performance

Sine/cosine periods per revolution	1,024
Measuring step	90°, electric/pulses per revolution
Measuring step deviation at binary number of lines	± 0.008°
Error limits	± 0.03°

Interfaces

Communication interface	Incremental
Communication Interface detail	Sin/Cos ¹⁾
Number of signal channels	6-channel
Initialization time	40 ms
Output frequency	≤ 200 kHz
Load current	≤ 30 mA
Operating current	40 mA (without load)
Load resistance	≥ 120 Ω

¹⁾ 1.0 V_{SS} (differential).

Electronics

Connection type	Male connector, M12, 8-pin, radial
Supply voltage	4.5 ... 5.5 V

¹⁾ Short-circuit opposite to another channel, US or GND permissible for maximum 30 s.

Reference signal, number	1
Reference signal, position	90°, electronically, gated with Sinus and Cosinus
Reverse polarity protection	✓
Short-circuit protection of the outputs	✓ ¹⁾

¹⁾ Short-circuit opposite to another channel, US or GND permissible for maximum 30 s.

Mechanics

Mechanical design	Blind hollow shaft
Shaft diameter	5/8" Front clamp
Weight	+ 0.5 kg
Shaft material	Stainless steel V2A
Flange material	Stainless steel V2A
Housing material	Stainless steel V2A
Start up torque	1 Ncm (+20 °C)
Operating torque	0.5 Ncm (+20 °C)
Permissible movement static	± 0.3 mm (radial) ± 0.5 mm (axial)
Permissible movement dynamic	± 0.05 mm (radial) ± 0.01 mm (axial)
Operating speed	≤ 6,000 min ⁻¹ ¹⁾
Moment of inertia of the rotor	40 gcm ²
Bearing lifetime	3.6 x 10 ¹⁰ revolutions
Angular acceleration	≤ 500,000 rad/s ²

¹⁾ Allow for self-heating of 3.3 K per 1,000 rpm when designing the operating temperature range.

Ambient data

EMC	According to EN 61000-6-2 and EN 61000-6-3
Enclosure rating	IP67, housing side (IEC 60529) ¹⁾ IP67, shaft side (IEC 60529)
Permissible relative humidity	90 % (Condensation not permitted)
Operating temperature range	-40 °C ... +100 °C ²⁾ -30 °C ... +100 °C ³⁾
Storage temperature range	-40 °C ... +100 °C, without package
Resistance to shocks	100 g, 6 ms (EN 60068-2-27)
Resistance to vibration	10 g, 10 Hz ... 2,000 Hz (EN 60068-2-6)

¹⁾ With mating connector fitted.

²⁾ Stationary position of the cable.

³⁾ Flexible position of the cable.

Certificates

EU declaration of conformity	✓
UK declaration of conformity	✓
ACMA declaration of conformity	✓
Moroccan declaration of conformity	✓

China RoHS	✓
cULus certificate	✓
Information according to Art. 3 of Data Act (Regulation EU 2023/2854)	✓

Classifications

ECLASS 5.0	27270501
ECLASS 5.1.4	27270501
ECLASS 6.0	27270590
ECLASS 6.2	27270590
ECLASS 7.0	27270501
ECLASS 8.0	27270501
ECLASS 8.1	27270501
ECLASS 9.0	27270501
ECLASS 10.0	27270501
ECLASS 11.0	27270501
ECLASS 12.0	27270501
ETIM 5.0	EC001486
ETIM 6.0	EC001486
ETIM 7.0	EC001486
ETIM 8.0	EC001486
UNSPSC 16.0901	41112113

Dimensional drawing

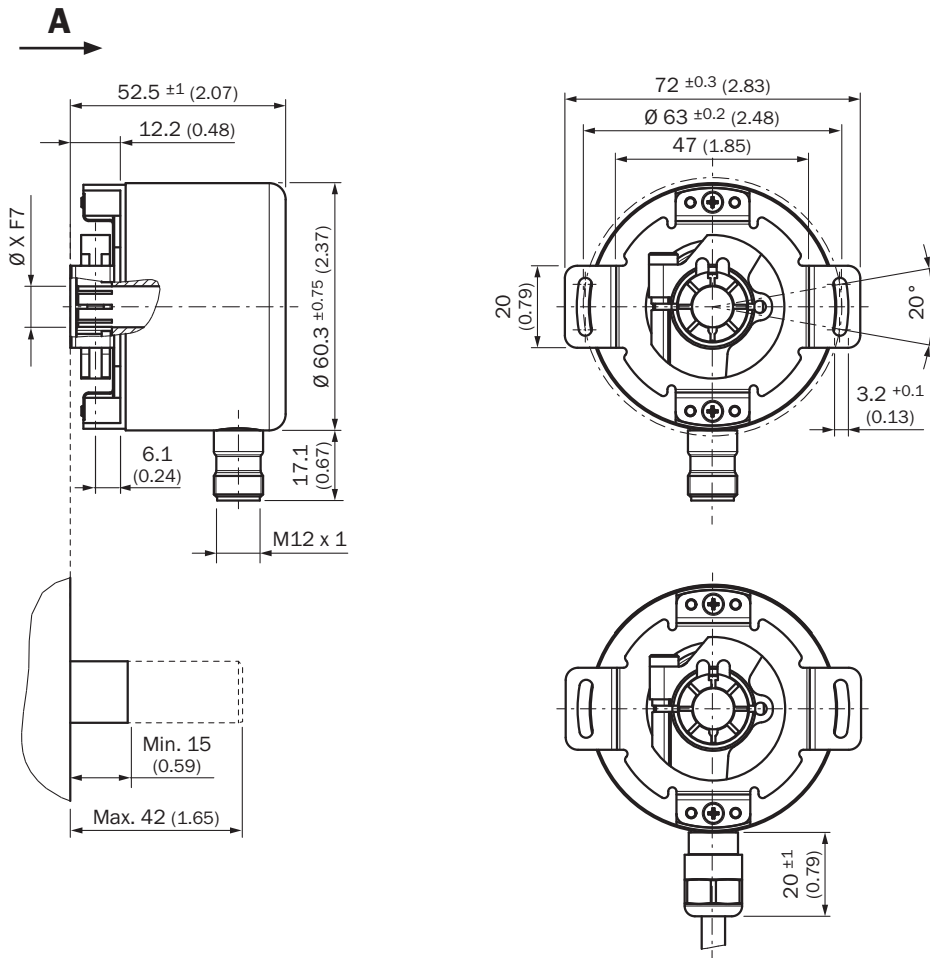

Dimensions in mm (inch)

PIN assignment

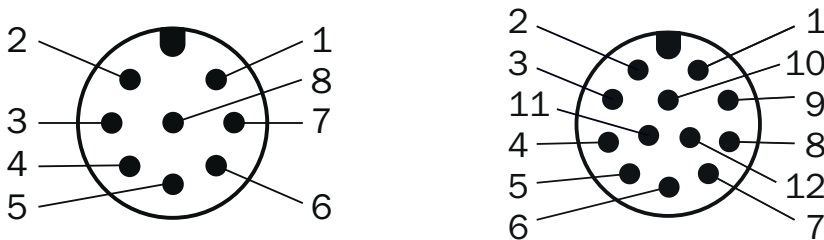

view of M12 male device connector on encoder

Male connector M12, 8-pin	Connector M12, 12-pin	Wire colors (cable connection)	TTL/HTL signal	Sin/Cos 1.0 V _{PP}	Explanation
1	7	Brown	\bar{A}	COS-	Signal wire
2	6	White	A	COS+	Signal wire
3	9	Black	\bar{B}	SIN-	Signal wire

Male connector M12, 8-pin	Connector M12, 12-pin	Wire colors (cable connection)	TTL/HTL signal	Sin/Cos 1.0 V _{PP}	Explanation
4	8	Pink	B	SIN+	Signal wire
5	4	Yellow	\bar{Z}	\bar{Z}	Signal wire
6	11	Purple	Z	Z	Signal wire
7	12	Blue	GND	GND	Ground connection
8	5	Red	+U _S	+U _S	Supply voltage
-	2	-	N.c.	N.c.	Not assigned
-	3	-	N.c.	N.c.	Not assigned
-	1	-	N.c.	N.c.	Not assigned
-	10 ¹⁾	-	O-SET ¹⁾	N.c.	Set zero pulse ¹⁾
Screen	Screen	Screen	Screen	Screen	Screen connected to housing on encoder side. Connected to ground on control side.

Diagrams Signal SIN/COS after differential generation

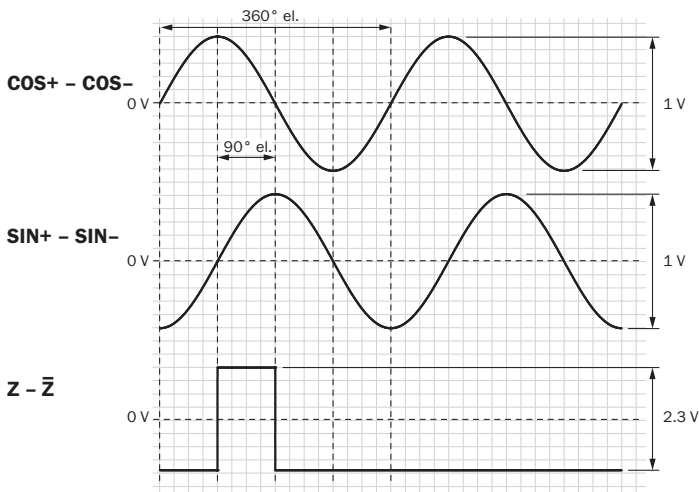

For clockwise shaft rotation, looking in direction "A" (see dimensional drawing)

Supply voltage	Output
4,5 V ... 5,5 V	Sin/Cos 1.0 V _{PP}

Diagrams Signal SIN/COS before differential generation

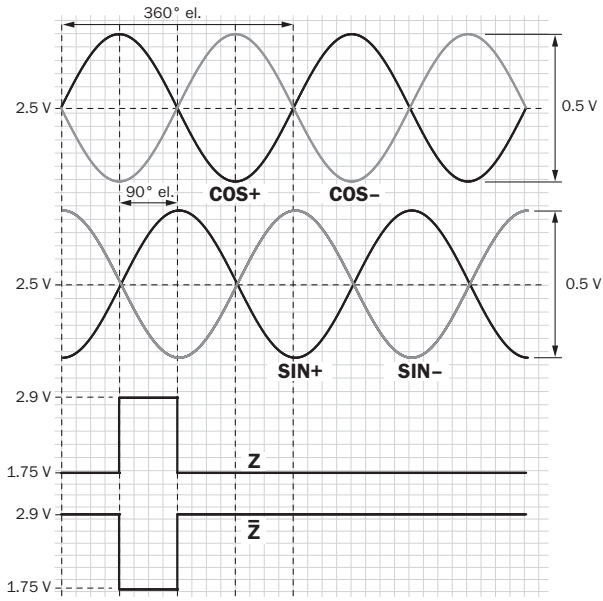

For clockwise shaft rotation, looking in direction "A" (see dimensional drawing)

Signal	Interface signals	Signal before differential generation At load 120 Ω	Signal offset
+ SIN- SIN+ COS- COS	Analog, differential	0,5 V _{SS} ± 20 %	2,5 V ± 10 %
ZZ_	Digital differential	Low: 1,75 V ± 15 %, High: 2,90 V ± 15 %	-



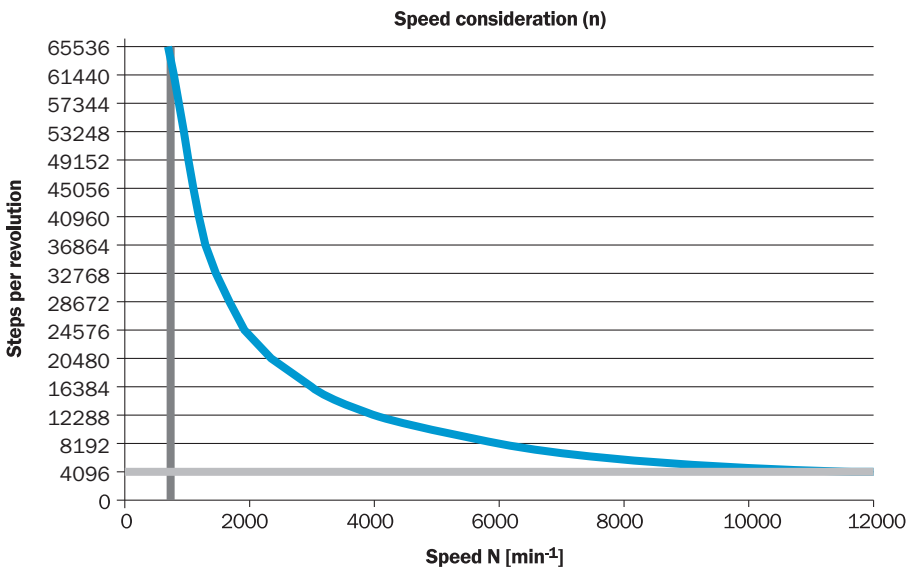









maximum revolution range



Recommended accessories

Other models and accessories → www.sick.com/DFS60

	Brief description	Type	part no.
Mounting systems			
	<ul style="list-style-type: none">• Product family: Stator couplings• Description: Standard stator coupling	BEF-DS00XFX	2056812

	Brief description	Type	part no.
shaft adaptation			
	<ul style="list-style-type: none"> • Product segment: Shaft adaptation • Product: Collets • Description: Collet plastic (PEEK) insulated for hollow shaft, shaft diameter 6 mm, outer diameter 5/8" (15.875 mm) 	SPZ-58Z-006-P	2076228
	<ul style="list-style-type: none"> • Product segment: Shaft adaptation • Product: Collets • Description: Collet metal for hollow shaft, shaft diameter 8 mm, outer diameter 5/8" (15.875 mm) 	SPZ-58Z-008-M	2076219
	<ul style="list-style-type: none"> • Product segment: Shaft adaptation • Product: Collets • Description: Collet plastic (PEEK) insulated for hollow shaft, shaft diameter 8 mm, outer diameter 5/8" (15.875 mm) 	SPZ-58Z-008-P	2076229
	<ul style="list-style-type: none"> • Product segment: Shaft adaptation • Product: Collets • Description: Collet metal for hollow shaft, shaft diameter 10 mm, outer diameter 5/8" (15.875 mm) 	SPZ-58Z-010-M	2076220
	<ul style="list-style-type: none"> • Product segment: Shaft adaptation • Product: Collets • Description: Collet plastic (PEEK) insulated for hollow shaft, shaft diameter 10 mm, outer diameter 5/8" (15.875 mm) 	SPZ-58Z-010-P	2076230
	<ul style="list-style-type: none"> • Product segment: Shaft adaptation • Product: Collets • Description: Collet metal for hollow shaft, shaft diameter 11 mm, outer diameter 5/8" (15.875 mm) 	SPZ-58Z-011-M	2094671
	<ul style="list-style-type: none"> • Product segment: Shaft adaptation • Product: Collets • Description: Collet metal for hollow shaft, shaft diameter 12 mm, outer diameter 5/8" (15.875 mm) 	SPZ-58Z-012-M	2076221
	<ul style="list-style-type: none"> • Product segment: Shaft adaptation • Product: Collets • Description: Collet plastic (PEEK) insulated for hollow shaft, shaft diameter 12 mm, outer diameter 5/8" (15.875 mm) 	SPZ-58Z-012-P	2076231
	<ul style="list-style-type: none"> • Product segment: Shaft adaptation • Product: Collets • Description: Collet metal for hollow shaft, shaft diameter 14 mm, outer diameter 5/8" (15.875 mm) 	SPZ-58Z-014-M	2076222
	<ul style="list-style-type: none"> • Product segment: Shaft adaptation • Product: Collets • Description: Collet plastic (PEEK) insulated for hollow shaft, shaft diameter 14 mm, outer diameter 5/8" (15.875 mm) 	SPZ-58Z-014-P	2076232
	<ul style="list-style-type: none"> • Product segment: Shaft adaptation • Product: Collets • Description: Collet metal for hollow shaft, shaft diameter 15 mm, outer diameter 5/8" (15.875 mm) 	SPZ-58Z-015-M	2076223
	<ul style="list-style-type: none"> • Product segment: Shaft adaptation • Product: Collets • Description: Collet plastic (PEEK) insulated for hollow shaft, shaft diameter 15 mm, outer diameter 5/8" (15.875 mm) 	SPZ-58Z-015-P	2076233
	<ul style="list-style-type: none"> • Product segment: Shaft adaptation • Product: Collets • Description: Collet metal for hollow shaft, shaft diameter 1/2" (12.7 mm), outer diameter 5/8" (15.875 mm) 	SPZ-58Z-12Z-M	2076225
	<ul style="list-style-type: none"> • Product segment: Shaft adaptation • Product: Collets • Description: Collet plastic (PEEK) insulated for hollow shaft, shaft diameter 1/2" (12.7 mm), outer diameter 5/8" (15.875 mm) 	SPZ-58Z-12Z-P	2076227
	<ul style="list-style-type: none"> • Product segment: Shaft adaptation • Product: Collets • Description: Collet metal for hollow shaft, shaft diameter 3/8" (9.525 mm), outer diameter 5/8" (15.875 mm) 	SPZ-58Z-38Z-M	2076224
	<ul style="list-style-type: none"> • Product segment: Shaft adaptation • Product: Collets • Description: Collet plastic (PEEK) insulated for hollow shaft, shaft diameter 3/8" (9.525 mm), outer diameter 5/8" (15.875 mm) 	SPZ-58Z-38Z-P	2076226

	Brief description	Type	part no.
connectors and cables			
	<ul style="list-style-type: none"> Description: Incremental, shielded, SSI Connection type head A: Female connector, M12, 8-pin, straight Connection type head B: Flying leads Signal type: Incremental, SSI Cable: 2 m, 8-wire, PUR, halogen-free Connection systems: Flying leads Application: Drag chain operation, Zones with oils and lubricants 	DOL-1208-G02MAC1	6032866
	<ul style="list-style-type: none"> Connection type head A: Female connector, M12, 8-pin, straight, A-coded Connection type head B: Flying leads Signal type: Incremental, SSI Cable: 2 m, 8-wire, PUR, halogen-free Description: Incremental, shielded, SSI Connection systems: Flying leads 	DOL-1208-G02MIE1	2120313
	<ul style="list-style-type: none"> Description: Incremental, shielded, SSI Connection type head A: Female connector, M12, 8-pin, straight Connection type head B: Flying leads Signal type: Incremental, SSI Cable: 5 m, 8-wire, PUR, halogen-free Connection systems: Flying leads Application: Drag chain operation, Zones with oils and lubricants 	DOL-1208-G05MAC1	6032867
	<ul style="list-style-type: none"> Description: Incremental, shielded, SSI Connection type head A: Female connector, M12, 8-pin, straight Connection type head B: Flying leads Signal type: Incremental, SSI Cable: 10 m, 8-wire, PUR, halogen-free Connection systems: Flying leads Application: Drag chain operation, Zones with oils and lubricants 	DOL-1208-G10MAC1	6032868
	<ul style="list-style-type: none"> Description: Incremental, shielded, SSI Connection type head A: Female connector, M12, 8-pin, straight Connection type head B: Flying leads Signal type: Incremental, SSI Cable: 20 m, 8-wire, PUR, halogen-free Connection systems: Flying leads Application: Drag chain operation, Zones with oils and lubricants 	DOL-1208-G20MAC1	6032869
	<ul style="list-style-type: none"> Description: Incremental, shielded, SSI Connection type head A: Female connector, M12, 8-pin, straight Connection type head B: Flying leads Signal type: Incremental, SSI Cable: 25 m, 8-wire, PUR, halogen-free Connection systems: Flying leads Application: Drag chain operation, Zones with oils and lubricants 	DOL-1208-G25MAC1	6067859
	<ul style="list-style-type: none"> Description: Shielded Connection type head A: Male connector, M12, 8-pin, straight, A-coded Connection systems: Screw-type terminals Permitted cross-section: ≤ 0.5 mm² Application: Hygienic and washdown zones 	YM12ES8-0050S5586A	2097337
	<ul style="list-style-type: none"> Description: Incremental, shielded, SSI Connection type head A: Female connector, M12, 8-pin, straight, A-coded Signal type: Incremental, SSI Cable: CAT5, CAT5e Connection systems: IDC quick connection Permitted cross-section: 0.14 mm² ... 0.34 mm² 	DOS-1208-GA01	6045001
	<ul style="list-style-type: none"> Description: Shielded Connection type head A: Female connector, M12, 8-pin, straight, A-coded Connection systems: Screw-type terminals Permitted cross-section: 0.25 mm² ... 0.5 mm² Application: Hygienic and washdown zones 	YF12ES8-0050S5586A	2097334

SICK AT A GLANCE

SICK is one of the leading manufacturers of intelligent sensors and sensor solutions for industrial applications. A unique range of products and services creates the perfect basis for controlling processes securely and efficiently, protecting individuals from accidents and preventing damage to the environment.

We have extensive experience in a wide range of industries and understand their processes and requirements. With intelligent sensors, we can deliver exactly what our customers need. In application centers in Europe, Asia and North America, system solutions are tested and optimized in accordance with customer specifications. All this makes us a reliable supplier and development partner.

Comprehensive services complete our offering: SICK LifeTime Services provide support throughout the machine life cycle and ensure safety and productivity.

For us, that is “Sensor Intelligence.”

WORLDWIDE PRESENCE:

Contacts and other locations –www.sick.com