



IMS12-04BPOVU2S

IMS

INDUCTIVE PROXIMITY SENSORS

SICK
Sensor Intelligence.



Ordering information

| Type | part no. |
|-----------------|----------|
| IMS12-04BPOVU2S | 1097642 |

Included in delivery: BEF-MU-M12 (1)

Other models and accessories → www.sick.com/IMS

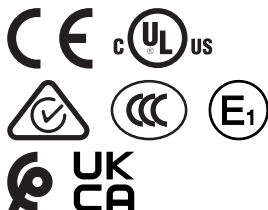

Detailed technical data

Features

| | |
|--------------------------------------------|---------------------------------------------------------------------------------------|
| Housing | Metric |
| Housing | Standard design |
| Thread size | M12 x 1 |
| Diameter | Ø 12 mm |
| Sensing range S_n | 4 mm |
| Safe sensing range S_a | 3.24 mm |
| Installation type | Flush |
| Switching frequency | 2,000 Hz |
| Connection type | Cable, 3-wire, 2 m |
| Switching output | PNP |
| Switching output detail | PNP |
| Output function | NC |
| Electrical wiring | DC 3-wire |
| Enclosure rating | IP68 ¹⁾ IP69K ²⁾ |
| Special features | Resistant against coolant lubricants, Temperature resistance |
| Special applications | Mobile machines, Zones with coolants and lubricants, Difficult application conditions |
| Items supplied | Mounting nut, brass, nickel-plated (2x) |

¹⁾ According to EN 60529.

²⁾ According to ISO 20653:2013-03.

Mechanics/electronics

| | |
|-----------------------|----------------------|
| Supply voltage | 7.2 V DC ... 60 V DC |
|-----------------------|----------------------|

¹⁾ At I_a max.

²⁾ Supply voltage U_B and constant ambient temperature T_a .

³⁾ See "Continuous current I_a above temperature" characteristic curve.

| | |
|---------------------------------------------|----------------------------------------------------------------------------------------------------------------------------------------------------------------------------------------------------------------------------------------------------------------------------------------------------------------------------------------------------------------------------------------------------------------------------------------------------------------------------------------------------------------------------------------------------------------------------------------------------------------------------------------------------------------------------------------------------------------------------------------------|
| Ripple | ≤ 10 % |
| Voltage drop | ≤ 2.5 V ¹⁾ |
| Time delay before availability | 100 ms |
| Hysteresis | 3 % ... 20 % |
| Reproducibility | ≤ 2 % ²⁾ |
| Temperature drift (of S_r) | ± 10 % |
| EMC | <p>Emitted interference and interference immunity in accordance with Motor Insurance Directive ECE-R10 Rev. 5: E1-Type approval</p> <p>Interference immunity in accordance with DIN ISO 11452-2: 100 V/m AM vertical 20 MHz - 800 MHz; AM horizontal 200 MHz - 800 MHz; PM vertical/horizontal 800 MHz - 2.7 GHz</p> <p>Conducted disturbances in accordance with ISO 7637-2 (pulse/severity/failure criterion 12 V/failure criterion 24 V): 1/IV/C/C, 2a/IV/A/A, 2b/IV/C/C, 3a/IV/A/A, 3b/IV/A/A, 4/IV/C/A, 5a/IV/B/B, 5b/IV/B/B</p> <p>EN 61000-4-2 ESD: 4 kV CD / 8 kV AD EN 61000-4-3 HF radiated: 10 V/m EN 61000-4-4 burst: 2 kV EN 61000-4-5 surge: 0,5 kV L-to-L, Ri: 2 Ohm EN 61000-4-6 HF wire-bound: 10 V</p> |
| Environmental test | Quick temperature change EN 60068-2-14, Na: TA = -25 °C, TB = 75 °C, t1 = 40 min, t2 = < 10 s, 300 cycles, Delta S _r ≤ 10% |
| Corrosion test | Salt spray test EN 60068-2-52: severity 5, 4 cycles |
| Continuous current I_a | ≤ 200 mA ³⁾ |
| No load current | ≤ 10 mA |
| Cable material | PUR |
| Conductor size | 0.5 mm ² |
| Cable diameter | Ø 5 mm |
| Short-circuit protection | ✓ |
| Power-up pulse protection | ✓ |
| Shock and vibration resistance | <p>Vibration resistance EN 60068-2-6 Fc: 25 g peak (10 Hz ... 2,000 Hz) / -20 °C ... +50 °C</p> <p>Shock resistance EN 60068-2-27 Ea: 100 g 11 ms; 3 shocks in every direction of the 3 coordinate axes / -40 °C ... +85 °C</p> <p>Continuous shock resistance EN 60068-2-29 Eb: 40 g 3 ms rise, 7 ms fall / 5,000 shocks in every direction of the 3 coordinate axes / -20 °C ... +50 °C</p> <p>Broadband noise EN 60068-2-64: 15 g rms (5 Hz ... 2,000 Hz) / 8 hours in every direction of the 3 coordinate axes / -40 °C ... +85 °C</p> |
| Ambient operating temperature | -40 °C ... +100 °C |
| Housing material | Stainless steel V2A, DIN 1.4305 / AISI 303 |
| Sensing face material | Plastic, LCP |
| Housing length | 56 mm |
| Thread length | 51 mm |
| Tightening torque, max. | Typ. 20 Nm |
| Protection class | III |
| UL File No. | E181493 |

¹⁾ At I_a max.

²⁾ Supply voltage U_B and constant ambient temperature Ta.

³⁾ See "Continuous current I_a above temperature" characteristic curve.

Safety-related parameters

| | |
|-------------------------|-------------|
| MTTF_D | 1,196 years |
| DC_{avg} | 0 % |

Reduction factors

| | |
|-----------------------------------|------------------------------------------------|
| Note | The values are reference values which may vary |
| Stainless steel (V2A, 304) | Approx. 0.65 |
| Aluminum (Al) | Approx. 0.35 |
| Copper (Cu) | Approx. 0.24 |
| Brass (Br) | Approx. 0.38 |

Installation note

| | |
|---------------|---------------------------------------|
| Remark | Associated graphic see "Installation" |
| B | 12 mm |
| C | 12 mm |
| D | 12 mm |
| F | 32 mm |

Classifications

| | |
|-----------------------|----------|
| ECLASS 5.0 | 27270101 |
| ECLASS 5.1.4 | 27270101 |
| ECLASS 6.0 | 27270101 |
| ECLASS 6.2 | 27270101 |
| ECLASS 7.0 | 27270101 |
| ECLASS 8.0 | 27270101 |
| ECLASS 8.1 | 27270101 |
| ECLASS 9.0 | 27270101 |
| ECLASS 10.0 | 27270101 |
| ECLASS 11.0 | 27270101 |
| ECLASS 12.0 | 27274001 |
| ETIM 5.0 | EC002714 |
| ETIM 6.0 | EC002714 |
| ETIM 7.0 | EC002714 |
| ETIM 8.0 | EC002714 |
| UNSPSC 16.0901 | 39122230 |

Certificates

| | |
|-------------------------------------------|---|
| EU declaration of conformity | ✓ |
| UK declaration of conformity | ✓ |
| ACMA declaration of conformity | ✓ |
| Moroccan declaration of conformity | ✓ |
| China RoHS | ✓ |
| CCC certificate | ✓ |
| cULus certificate | ✓ |

ECE test certificate



Installation note Flush installation

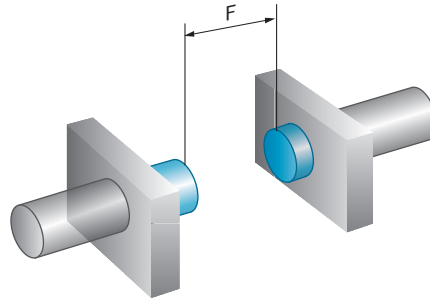
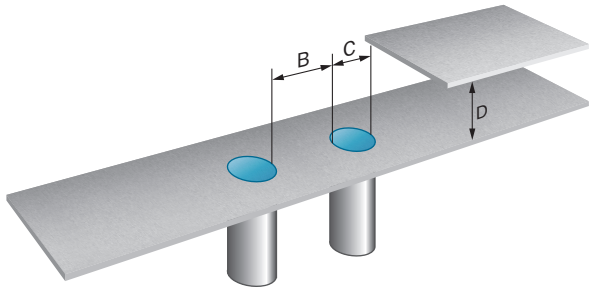

Connection diagram Cd-003

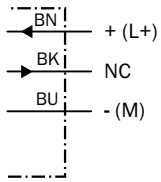

Temperature derating

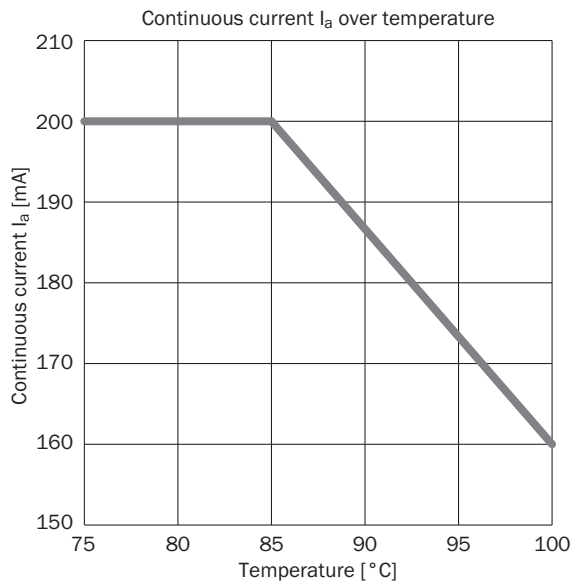

Response diagram

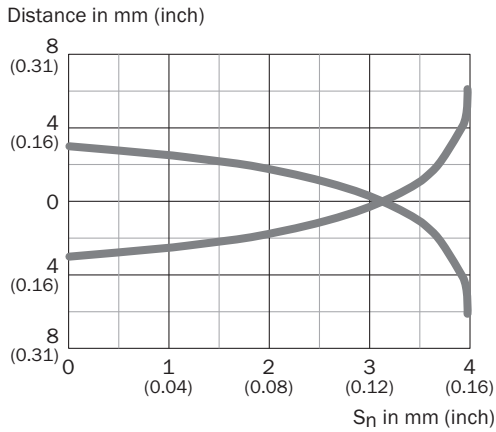

Dimensional drawing IMS12, V2A, flush

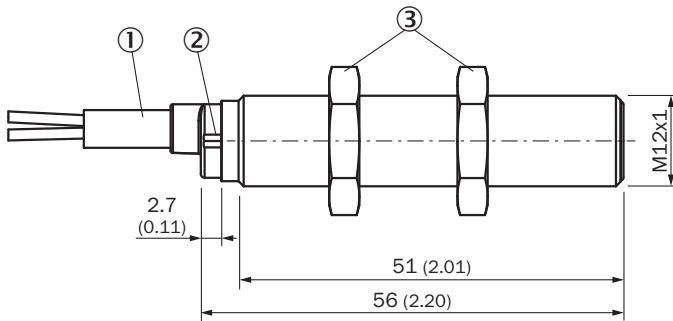



Dimensions in mm (inch)

- ① Connection
- ② Display LED
- ③ fastening nuts (2x); width across 17, brass nickel-plated

Recommended accessories

Other models and accessories → www.sick.com/IMS

| | Brief description | Type | part no. |
|-------------------------------------------------------------------------------------|------------------------------------------------------------------------------------------------------------------------------------------------------------------------------------------------------------------------------------------------------------------------------------------------------------------------------------------------------------------------------------------------------------------------------------------------------------------------------------------------|--------------|----------|
| Mounting systems | | | |
|  | <ul style="list-style-type: none"> • Description: Plate N06N for universal clamp bracket, M18 • Material: Stainless steel, stainless steel • Details: Stainless steel 1.4571 (sheet), Stainless steel 1.4408 (clamp) • Items supplied: Universal clamp (5322627), mounting hardware • Usable for: MH15, MH15V, V180-2, V18V, W15, GR18, V18, V18 Laser, V12-2, SimpleSense, SureSense, M18 round sensors | BEF-KHS-N06N | 2051622 |
|  | <ul style="list-style-type: none"> • Description: Mounting bracket for M12 sensors • Material: Steel • Details: Steel, zinc coated • Items supplied: Without mounting hardware | BEF-WN-M12 | 5308447 |

SICK AT A GLANCE

SICK is one of the leading manufacturers of intelligent sensors and sensor solutions for industrial applications. A unique range of products and services creates the perfect basis for controlling processes securely and efficiently, protecting individuals from accidents and preventing damage to the environment.

We have extensive experience in a wide range of industries and understand their processes and requirements. With intelligent sensors, we can deliver exactly what our customers need. In application centers in Europe, Asia and North America, system solutions are tested and optimized in accordance with customer specifications. All this makes us a reliable supplier and development partner.

Comprehensive services complete our offering: SICK LifeTime Services provide support throughout the machine life cycle and ensure safety and productivity.

For us, that is “Sensor Intelligence.”

WORLDWIDE PRESENCE:

Contacts and other locations –www.sick.com