



ZLD18-APZ3B8

Z18 Simple Sense

PHOTOELECTRIC SENSORS

SICK
Sensor Intelligence.



Illustration may differ



Ordering information

| Type | part no. |
|--------------|----------|
| ZLD18-APZ3B8 | 1096987 |

Included in delivery: BEF-MU-M18*1 (2)

Other models and accessories → www.sick.com/Z18_Simple_Sense

Detailed technical data

Features

| | |
|--|---|
| Functional principle | Photoelectric retro-reflective sensor |
| Functional principle detail | With minimum distance to reflector (dual lens system) |
| Dimensions (W x H x D) | 13.6 mm x 34.8 mm x 23 mm |
| Housing design (light emission) | Hybrid |
| Thread diameter (housing) | M18 |
| Mounting system type | M18, head/side (24.1 ... 25.4 mm) |
| Housing color | Transparent |
| Sensing range max. | 0 m ... 5 m ¹⁾ |
| Sensing range | 0 m ... 4.2 m ¹⁾ |
| Type of light | Visible red light |
| Light source | LED |
| Light spot size (distance) | Ø 125 mm (1,000 mm) |
| Wave length | 625 nm |

¹⁾ Reflector PL80A.

Mechanics/electronics

| | |
|--|-----------------------|
| Supply voltage U_B | 10 V DC ... 30 V DC |
| Ripple | < 10 % |
| Current consumption | ≤ 15 mA ¹⁾ |

¹⁾ Without load.

²⁾ Signal transit time with resistive load.

³⁾ With light/dark ratio 1:1.

⁴⁾ A = V_S connections reverse-polarity protected.

⁵⁾ B = inputs and output reverse-polarity protected.

⁶⁾ D = outputs overcurrent and short-circuit protected.

| | |
|---|---|
| Switching output | PNP |
| Switching mode | Light switching |
| Switching output detail | |
| Switching output Q1 | PNP, Light switching |
| Switching output Q2 | Not connected |
| Output current I_{\max} | 100 mA |
| Response time | $\leq 500 \mu\text{s}$ ²⁾ |
| Switching frequency | 1,000 kHz ³⁾ |
| Connection type | Cable with M8 male connector, 4-pin, 150 mm |
| Cable material | Plastic, PVC |
| Conductor cross section | 0.13 mm ² |
| Circuit protection | A ⁴⁾ B ⁵⁾ D ⁶⁾ |
| Protection class | III |
| Weight | 3.63 g |
| Polarizing filter | ✓ |
| Housing material | Plastic, ABS |
| Optics material | Plastic, PMMA |
| Enclosure rating | IP67 |
| Ambient operating temperature | -40 °C ... +55 °C |
| Ambient temperature, storage | -40 °C ... +70 °C |
| UL File No. | E189383 |

¹⁾ Without load.

²⁾ Signal transit time with resistive load.

³⁾ With light/dark ratio 1:1.

⁴⁾ A = V_S connections reverse-polarity protected.

⁵⁾ B = inputs and output reverse-polarity protected.

⁶⁾ D = outputs overcurrent and short-circuit protected.

Connection type/pinouts

| | |
|-------------------------------|---|
| Connection type | |
| | Cable with M8 male connector, 4-pin, 150 mm |
| Connection type Detail | |
| Cable material | Plastic |
| Conductor cross section | 0.13 mm ² |
| Pinouts | |
| BN 1 | + (L+) |
| WH 2 | Not connected |
| BU 3 | - (M) |
| BK 4 | Q ₁ |

Certificates

| | |
|-------------------------------------|---|
| EU declaration of conformity | ✓ |
|-------------------------------------|---|

| | |
|---|---|
| UK declaration of conformity | ✓ |
| ACMA declaration of conformity | ✓ |
| Moroccan declaration of conformity | ✓ |
| China RoHS | ✓ |

Classifications

| | |
|-----------------------|----------|
| ECLASS 5.0 | 27270902 |
| ECLASS 5.1.4 | 27270902 |
| ECLASS 6.0 | 27270902 |
| ECLASS 6.2 | 27270902 |
| ECLASS 7.0 | 27270902 |
| ECLASS 8.0 | 27270902 |
| ECLASS 8.1 | 27270902 |
| ECLASS 9.0 | 27270902 |
| ECLASS 10.0 | 27270902 |
| ECLASS 11.0 | 27270902 |
| ECLASS 12.0 | 27270902 |
| ETIM 5.0 | EC002717 |
| ETIM 6.0 | EC002717 |
| ETIM 7.0 | EC002717 |
| ETIM 8.0 | EC002717 |
| UNSPSC 16.0901 | 39121528 |

Pinouts, see table [Technical data: Connection type/pinouts](#)

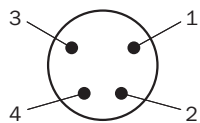

Male connector, M8, 4-pin, uncoded

Connection diagram Cd-243

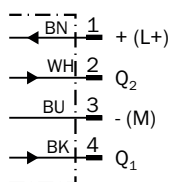

Characteristic curve

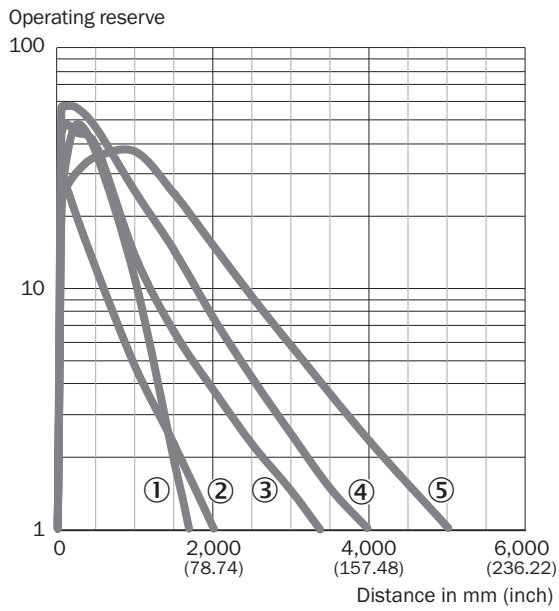

- ① Reflector PL23 FT
- ② Reflector PL20A
- ③ Reflector PL250
- ④ Reflector PL40A
- ⑤ Reflector PL80A

Sensing range diagram

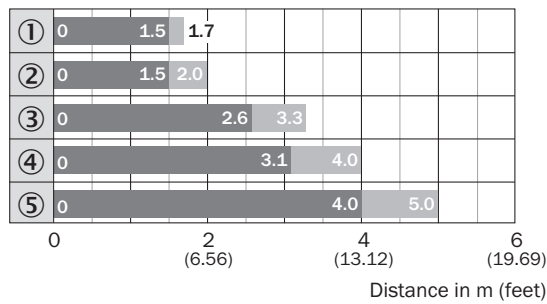

- Sensing range
- Sensing range max.
- ① Reflector PL23 FT
- ② Reflector PL20A
- ③ Reflector PL250
- ④ Reflector PL40A
- ⑤ Reflector PL80A

Dimensional drawing

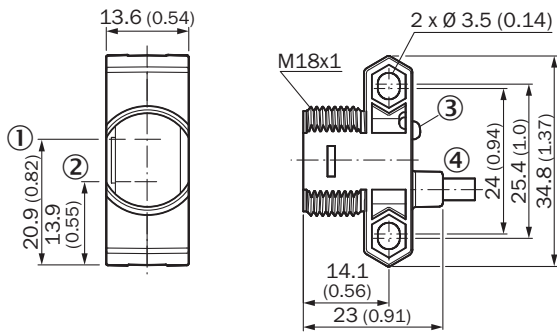







Dimensions in mm (inch)

- ① optical axis, sender
- ② optical axis, receiver
- ③ LED status indicator
- ④ Connection

Recommended accessories

Other models and accessories → www.sick.com/Z18_Simple_Sense

| | Brief description | Type | part no. |
|---|---|--------------|----------|
| Mounting systems | | | |
|  | <ul style="list-style-type: none"> Description: Universal mounting bracket for reflectors Dimensions (W x H x L): 85 mm x 90 mm x 35 mm Material: Steel Details: Steel, zinc coated Suitable for: C110A, P250, PL20, PL30A, PL40A, PL80A | BEF-WN-REFX | 2064574 |
|  | <ul style="list-style-type: none"> Description: Mounting bracket for M18 sensors Material: Steel Details: Steel, zinc coated Items supplied: Without mounting hardware Suitable for: GR18, V180-2, V18, W15, Z1, Z2 | BEF-WN-M18 | 5308446 |
|  | <ul style="list-style-type: none"> Description: Plate N11N for universal clamp bracket Material: Stainless steel Details: Stainless steel 1.4571 (sheet), Stainless steel 1.4408 (clamp) Items supplied: Universal clamp (5322627), mounting hardware Usable for: DeltaPac, Glare, WTD20E | BEF-KHS-N11N | 2071081 |
| reflectors and optics | | | |
|  | <ul style="list-style-type: none"> Description: Rectangular, screw connection Dimensions: 51 mm x 61 mm Ambient operating temperature: -30 °C ... +65 °C | P250 | 5304812 |

| | Brief description | Type | part no. |
|---|---|--------------------|----------|
| connectors and cables | | | |
|  | <ul style="list-style-type: none"> • Connection type head A: Female connector, M8, 4-pin, straight, A-coded • Connection type head B: Flying leads • Signal type: Sensor/actuator cable • Cable: 5 m, 4-wire, PVC • Description: Sensor/actuator cable, unshielded • Application: Uncontaminated zones, Zones with chemicals | YF8U14-050VA3XLEAX | 2095889 |
|  | <ul style="list-style-type: none"> • Description: Unshielded • Connection type head A: Male connector, M8, 4-pin, straight, A-coded • Connection systems: Screw-type terminals • Permitted cross-section: 0.14 mm² ... 0.5 mm² | STE-0804-G | 6037323 |
|  | <ul style="list-style-type: none"> • Connection type head A: Female connector, M8, 4-pin, straight, A-coded • Connection type head B: Flying leads • Signal type: Sensor/actuator cable • Cable: 5 m, 4-wire, PUR, halogen-free • Description: Sensor/actuator cable, unshielded • Application: Drag chain operation, Zones with oils and lubricants, Robot, Drag chain operation | YF8U14-050UA3XLEAX | 2094792 |

SICK AT A GLANCE

SICK is one of the leading manufacturers of intelligent sensors and sensor solutions for industrial applications. A unique range of products and services creates the perfect basis for controlling processes securely and efficiently, protecting individuals from accidents and preventing damage to the environment.

We have extensive experience in a wide range of industries and understand their processes and requirements. With intelligent sensors, we can deliver exactly what our customers need. In application centers in Europe, Asia and North America, system solutions are tested and optimized in accordance with customer specifications. All this makes us a reliable supplier and development partner.

Comprehensive services complete our offering: SICK LifeTime Services provide support throughout the machine life cycle and ensure safety and productivity.

For us, that is “Sensor Intelligence.”

WORLDWIDE PRESENCE:

Contacts and other locations –www.sick.com